



Annex 18 to the GTC of OeKB CSD
SWIFT Manual

V 1.0 / Public / 07 November 2022

Table of Contents

User Manual for SWIFT ISO 15022	5
1. SWIFT Manual for Settlement ISO 15022	6
1.1 Introduction.....	6
1.2 Overview – Notable Changes.....	8
1.3 Overview - Instruction Types.....	9
1.4 Settlement.....	11
1.4.1 Settlement Instructions – MT530 and MT540-543.....	11
1.4.2 Settlement Confirmations – MT544-547.....	85
1.4.3 Settlement Status and Processing Advice – MT548.....	136
1.4.4 Settlement Allegement – MT578	177
1.4.5 Intra-Position Movement (Settlement Restrictions) – MT524 and MT508	189
1.4.6 Statement of Holdings – MT535	201
1.4.7 Statement of Transactions – MT536.....	207
1.4.8 Penalty Report - MT537	217
2. SWIFT Manual for Income and Corporate Actions ISO 15022	249
2.1 Introduction.....	249
2.2 Scope.....	249
2.2.1 Income Event List (SWIFT ISO 15022).....	249
2.2.2 Event List for Corporate Actions (SWIFT ISO 15022).....	251
2.2.3 Communication Flow SWIFT ISO 15022	254
2.2.4 MAND Income Event Lifecycle	255
2.2.5 MAND Corporate Action Event Lifecycle	255
2.3 Income SWIFT Examples (SWIFT ISO 15022)	259
2.3.1 DVCA – Cash Dividend.....	259
2.3.2 DVCA – Investment Fund (Change of Dividend Rate).....	272
2.3.3 DVCA - Cash Dividend for a Non AT ISIN.....	275
2.3.4 INTR – Interest Payment Domestic ISIN.....	281
2.3.5 REDM – Final Maturity Domestic ISIN.....	286
2.3.6 EXWA – Warrant Exercise Domestic Market – Non Collection of Income for Securities Due.....	292
2.3.7 EXWA - Warrant Exercise	298

2.3.8	PCAL – Partial Redemption without Pool Factor Reduction	303
2.3.9	WRTH – Worthless with Domestic ISIN.....	313
2.3.10	PRED - Partial Redemption with Pool Factor Reduction Domestic ISIN	318
2.3.11	SHPR - Shares Premium Dividend for Domestic ISIN.....	324
2.4	Corporate Action SWIFT Examples (SWIFT ISO 15022)	329
2.4.1	MEET - Meeting	329
2.4.2	LIQU – Liquidation	332
2.4.3	TEND – Tender Offer.....	339
2.4.4	BIDS - Repurchase Offer/Issuer Bid/Reverse Rights	345
2.4.5	DSCL - Disclosure.....	349
2.4.6	PRIO - Priority Issue.....	353
2.4.7	EXRI – Call on Intermediate Securities	366
2.5	Corporate Action Instruction Process Management	378
2.5.1	Corporate Action Instruction MT565 (NEWM)	379
2.5.2	Corporate Action Instruction MT565 (CANC).....	380
2.5.3	Instruction Processing Flow (SWIFT ISO 15022).....	382
2.5.4	Instruction Cancellation Processing Flow (SWIFT ISO 15022)	385
3.	SWIFT Manual for Issuers ISO 15022	387
3.1	Issuer Information also via SWIFT ISO 15022	387
3.2	Change volume via SWIFT.....	387
3.2.1	MT540 - Receive Free of Payment (Increase).....	387
3.2.2	MT542 – Deliver Free of Payment (Decrease).....	398
3.2.3	MT546 – Deliver Free Confirmation	408
	User Manual for SWIFT ISO 20022	417
4.	SWIFT Manual for Settlement ISO 20022.....	418
5.	SWIFT Manual for Income and Corporate Actions ISO 20022	419
5.1	Introduction.....	419
5.2	Available message types in SWIFT ISO 20022:	419
5.3	Communication Flow under Shareholders Rights Directive (SRD II)	420
5.4	Incoming Messages SWIFT ISO 20022.....	420
5.4.1	Incoming Messages from Issuer/Issuer Agent/Custodian	420
5.4.2	Incoming Messages from Securities Account Holder.....	420
5.5	Outgoing Messages SWIFT ISO 20022.....	422

5.5.1	Outbound seev.001.001.09 (Meeting Notification)	423
5.5.2	Outbound seev.002.001.08 (MeetingCancellation)	430
5.5.3	Outbound seev.008.001.07 (MeetingResultDissemination)	431
5.5.4	Outbound seev.045.001.03 (ShareholdersIdentificationDisclosureRequest)	434
5.5.5	Outbound seev.046.001.01 (ShareholdersIdentificationDisclosureRequestCancellationAdvice)	437
6.	SWIFT Manual for Issuers ISO 20022	440
6.1	Issuer Agent – Information Provider	440
6.2	Incoming SWIFT ISO 20022 Messages	440
6.2.1	seev.001.001.09 (MeetingNotification9)	441
6.2.2	seev.002.001.08 (MeetingCancellation)	451
6.2.3	seev.008.001.07 (MeetingResultDissemination)	453
6.2.4	seev.045.001.03 (ShareholdersIdentificationDisclosureRequest)	458
6.2.5	seev.046.001.01 (ShareholdersIdentificationDisclosureRequestCancellationAdvice)	462
6.2.6	seev.049.001.01 (ShareholderIdentificationDisclosureResponseStatusAdviceV01)	465
6.2.7	Not accepted Incoming Messages	468
6.3	Outgoing SWIFT ISO 20022 Messages	469
6.3.1	seev.047.001.02 (ShareholdersIdentificationDisclosureResponse)	470
6.3.2	seev.048.001.01 (ShareholderIdentificationDisclosureResponseCancellationAdvice)	474

User Manual for SWIFT ISO 15022

1. SWIFT Manual for Settlement ISO 15022

1.1 Introduction

Starting with the migration to the European Settlement Platform T2S (TARGET2-Securities) the OeKB CSD will provide an ISO 15022 and an ISO 20022 interface for indirectly connected participants. The ISO 15022 interface will resemble the SWIFT interface for the Settlement Client as closely as possible.

Objective

This chapter describes the content requirements for ISO 15022 SWIFT messages to comply with the Settlement SWIFT interface of the OeKB CSD.

Additional documentation is provided in the form of *Annex 8 Guideline Settlement and Securities Account Administration* covering the settlement services of OeKB CSD und in the form of *Annex 17 User Manual Settlement Client*.

Scope

. This manual describes in detail the content requirements for each SWIFT field and highlights differences in the requirements for individual transaction types. Message examples complement the comprehensive descriptions *and* will be updated regularly.

For details on the functional processes, please refer to *Annex 8 Guideline Settlement and Securities Account Administration*.

The details of the examples given are fictitious and any resemblance to actual instructions is purely coincidental.

Interrelationship with other Documents

Document	Brief Description
Annex 17 User Manual Settlement Client	Description of the Settlement Client user interface
Annex 8 Guideline Settlement and Securities Account Administration	Outline of the scope of the OeKB CSD Settlement Services
Annex 25 Using T2S for Transaction Management	Description of the transaction management in the Austrian capital market using T2S.

Field description

The meaning of the individual table columns is as follows:

M/O Mandatory / Optional Fields

Incoming SWIFT Messages

Indicator	Description
	Including a value in this field of the SWIFT message is mandatory for processing by the OeKB CSD Settlement Services.
M	M plus OR requires an option to be selected.
	If this involves a field which is mandatory according to applicable SWIFT Standards and the field is empty, the SWIFT message will be rejected.
(M)	Including a value in this field is mandatory under certain circumstances for processing by the OeKB CSD Settlement Services. If such a field is not filled, the SWIFT message will be rejected by the OeKB CSD Settlement Services.
O	Including a value in this field is optional. If the field is filled, the included information will be processed and, if applicable, displayed by the OeKB CSD Settlement Services.

Outgoing SWIFT Messages

Indicator	Description
M	This field will always be filled by the OeKB CSD Settlement Services.
(M)	This field will be filled under certain circumstances by the OeKB CSD Settlement Services.
O	This field will be filled by the OeKB CSD Settlement Services only if the same information is contained in the SWIFT message sent as instruction or if it has been entered by the OeKB CSD customer on the Settlement Client.

Tag

— :98C:

If applicable SWIFT Standards or processing by the OeKB CSD Settlement Services only allow one option, this option will be indicated here.

— :98a:

If applicable SWIFT Standards or processing by the OeKB CSD Settlement Services allow more than one option, the letter "a" will function as a placeholder for the option. Available options are indicated in the column "Option".

Field Name

This column contains the field name according to applicable SWIFT Standards.

Qualifier

This column contains the qualifiers to be used for settlement.

Option

This column contains available options.

Format

The given format specification complies with applicable SWIFT Standards. If there is a diverging definition applicable for the OeKB CSD Settlement Services, it is explained under "Explanation of the SWIFT Fields".

Codes

This column specifies the codes to be used for settlement.

Description

This column contains comments on the code or the field content

1.2 Overview – Notable Changes

The following table gives a rough outline of the most notable changes in ISO 15022 format SWIFT messages relevant to T2S:

#	MT	SWIFT Content	Description	Other Documents
1	541/543/545/547		Additional instruction types are available: — RWP/DWP — PFOD	Annex 8 Guideline Settlement and Securities Account Administration
2	530/540-543/ 544-547		Hold/Release (PREA/NEWM) functionality	Annex 8 Guideline Settlement and Securities Account Administration
3	524/508		Settlement restrictions of the types: — Blocking — Reservation — Earmarking	Annex 8 Guideline Settlement and Securities Account Administration
4	530/540-543/ 544-547	:22F:	Partial settlement is supported (optional)	Annex 8 Guideline Settlement and Securities Account Administration

#	MT	SWIFT Content	Description	Other Documents
5	530/540-543/ 544-547		Processing priority of messages can be set (optional)	Annex 8 Guideline Settlement and Securities Account Administration
6	530/540-543 / 544-547 / 524/508		Linking of messages is supported.	Annex 8 Guideline Settlement and Securities Account Administration
7	540-543		<ul style="list-style-type: none"> — Mandatory matching fields — Additional matching fields (added new) — Optional matching fields (added new) 	Annex 8 Guideline Settlement and Securities Account Administration
8	540-543	:95P:DEAG/REAG	No Data Source Scheme -> customers are identified exclusively by BIC code	Annex 8 Guideline Settlement and Securities Account Administration
9	540-543		Complete delivery chain may be specified (e.g. incl. REI1, REI2, ...)	
10	540-543	:95P::PSET	BIC of the counterparty's CSD must be specified in PSET (depository)	Annex 8 Guideline Settlement and Securities Account Administration
11	540-543 / 544-547		No specification of intended settlement time -> only settlement date is specified	
12	540-543		Preparation date / time no longer required	
13	540-543	:23G:CANC :20C:PREV	Instruction details are not validated in cancellations.	
14	548	:25D:	Several status messages are possible in one MT548	
15	548	:24B:	A message may contain several reason codes. The reason code(s) and the rejection text are sent.	
16	548		Instruction details are not always included.	

1.3 Overview - Instruction Types

The following instruction types are available:

- **Delivery Free of Payment (FOP):** Securities are delivered or received without payment.

- DFP (Delivery Free of Payment)
 - RFP (Receive Free of Payment)
- **Delivery Versus Payment:** Securities are delivered or received versus payment. The securities account must be associated with a T2S DCA.
- DVP (Delivery versus Payment)
 - RVP (Receive versus Payment)
- **Delivery With Payment:** Securities are delivered or received together with payment. The securities account must be associated with a T2S DCA.
- DWP (Delivery with Payment)
 - RWP (Receive with Payment)
- **Payment Free of Delivery (PFD):** Payment is effected without securities being delivered or received. However, the instruction must contain an ISIN.
- **Payment or Credit Free of Delivery (PFoD):** Payment or Credit is effected without securities being delivered or received. However, the instruction must contain an ISIN.
- PFRD (Payment free of Receive Debit)
 - PFRC (Payment free of Receive Credit)
 - PFDD (Payment free of Delivery Debit)
 - PFDC (Payment free of Delivery Credit)

The following SWIFT messages are used for the above instruction types:

Inst. Type	ISO 15022	Settlement Quantity	Settlement Amount
RFP	MT540	> 0	n. a.
DFP	MT542	> 0	n. a.
RVP	MT541	> 0	> 0
DVP	MT543	> 0	> 0
PFRD	MT541	= 0	> 0
PFRC	MT541	= 0	< 0
PFDD	MT543	= 0	< 0
PFDC	MT543	= 0	> 0
RWP	MT541	> 0	< 0
DWP	MT543	> 0	< 0

The following tables provide an overview of the individual instruction types.

Incoming SWIFT Messages

Inst. Type	Incoming SWIFT Message Types					
	MT530	MT540	MT541	MT542	MT543	MT524
RFP	X	X				
RVP, RWP	X		X			
DFP	X			X		
DVP, DWP	X				X	
PFRD	X		X			
PFRC	X		X			
PFDD	X				X	
PFDC	X				X	
DPH		X				
WPH				X		
Restrictions						X

Outgoing SWIFT Messages

Inst. Type	Outgoing SWIFT Message Types						
	MT508	MT544	MT545	MT546	MT547	MT548	MT578
RFP		X				X	X
RVP, RWP			X			X	X
DFP				X		X	X
DVP, DWP					X	X	X
PFRD			X			X	X
PFRC			X			X	X
PFDD					X	X	X
PFDC					X	X	X
DPH		X					
WPH				X			
Restrictions	X						

The following chapters describe the individual transaction types and instruction types in detail.

1.4 Settlement

1.4.1 Settlement Instructions – MT530 and MT540-543

1.4.1.1 MT530 – Modification of Instructions (Transaction Processing Command)

MT530 is used to modify an already submitted settlement instruction. It is possible to modify the following indicators/attributes of an instruction:

- Hold/Release Indicator

- Partial Settlement Indicator
- Linkages
- Priority

An otherwise valid MT530 is accepted only after all responses to preceding activities (creation or prior changes) concerning the instruction in question have been received and processed.

MT530 is also used to send buy-in notifications.

1.4.1.2 Content

M/O	Tag	Field Name	Qualifier	Option	Format	Codes	Description
Mandatory Sequence A General Information							
M	:16R:	Start of Block			16c	GENL	
M	:20C:	Sender's Reference	SEME		:4!c//16x		Sender's Message Reference
M	:23G:	Function of the Message			4!c	NEWM	New message
M	:97A:	Safekeeping Account			:4!c/[8c]/4!c/35x	SAFE	OeKB CSD's securities account number of the customer
M	:16S:	End of Block			16c	GENL	
End of Sequence A General Information							
Mandatory Repetitive Sequence B Request Details							
M	:16R:	Start of Block			16c	REQD	
M	:20C:	Reference	PREV	C	:4!c//16x		Message reference of the linked message which was previously received.
			MITI	C	:4!c//16x		T2S Market Infrastructure Transaction Identification
			RELA	C	:4!c//16x		Message reference of the linked message which was previously received.

O	:22F:	Partial Settlement Indicator	PRTL	:4!c/[8c]/4!c	NPAR	Partial settlement is not allowed.
					PART	Partial settlement is allowed
		Settlement Process Indicator	SETT	:4!c/[8c]/4!c	YPRE	The instruction is to be presented for settlement.
					NPRE	The instruction is not to be presented for settlement.
		Linking Indicator	LINK	:4!c/[8c]/4!c	LINK	Request is to link the reference in B to the reference(s) in B1.
					UNLK	Request is to unlink the reference in B to the reference(s) in B1.
		Priority Indicator	PRIR	:4!c/[8c]/4!c	0003	High priority
					0004	Normal priority
		Buy-in Indicator	BYIY	:4!c/[8c]/4!c	BSSN	The buy-in was unsuccessful.
					BSSP	The buy-in was partially successful.
					BSSY	The buy-in was successful.

Optional Repetitive Subsequence B1 Linkages

M	:16R:	Start of Block		16c	LINK	
O	:22F:	Linkage Type Indicator	LINK	:4!c/[8c]/4!c	AFTE	Indicates that the message is to be processed after the linked message.
					BEFO	Indicates that the message is to be processed before the linked message.

					WITH	Indicates that the message is to be processed with the linked message.
M	:20C:	Reference	PREV	:4!c//16x		Message reference of the linked message which was previously sent.
			MITI			T2S Market Infrastructure Transaction Identification.
M	:16S:	End of Block		16c	LINK	
End of Subsequence B1 Linkages						
M	:16S:	End of Block		16c	REQD	
End of Sequence B Request Details						
Optional Repetitive Sequence C Additional Information						
M	:16R:	Start of Block		16c	ADDINFO	
O	:35B:	Identification of the Financial Instrument		ISIN1!e12!c		"ISIN" followed by <Blank> and ISIN Code
O	:36B:	Quantity of Financial Instrument to be Settled	SETT	:4!c//4!c/15d	FAMT	Face amount
					UNIT	Unit number
O	:90B:	Buy-in Price	BYIY	:4!c//4!c/[N]15d	ACTU	Price expressed as an amount of currency per unit or per share.
O	:19A:	Cash Compensation Amount	BCAM	:4!c//[N]3!a15d		Amount of money that has to be paid by the failing trading party in case of an unsuccessful or partially successful buy-in transaction.
M	:16S:	End of Block		16c	ADDINFO	

End of Sequence C Additional Information

1.4.1.3 Explanation of the SWIFT Fields

Mandatory Repetitive Sequence B Request Details

— :20C: - Sender's Reference

PREV: Customer reference of the modified instruction

MITI: Unique transaction reference of T2S

RELA: In case of modification orders for instructions, which have been created by an authorised party (instructing party is different from the instructing party of the instruction being modified), this field has to contain the PCTI reference from the MT 548 status message.

— :22F: - Partial Settlement Indicator

NPAR: Partial settlement of an instruction is not allowed.

PART: Partial settlement of an instruction is allowed.

For details, please see Annex 8 Guideline Settlement and Securities Account Administration.

— :22F: - Settlement Process Indicator

YPRE: The instruction is released for settlement (change from PREA to NEWM).

NPRE: The instruction is blocked for settlement (change from NEWM to PREA).

For details, please see Annex 8 Guideline Settlement and Securities Account Administration.

— :22F: - Settlement Linking Indicator

With an MT530 it is not possible to delete existing links and add new ones at the same time. Instead, a separate instruction each must be sent for deleting a link (UNLK) and for setting a new link (LINK).

For details, please see *Annex 8 Guideline Settlement and Securities Account Administration*.

— :22F: - Settlement Priority Indicator

The priority can be changed from "High Priority (0003)" to "Normal Priority (0004)" and vice versa.

For details, please see *Annex 8 Guideline Settlement and Securities Account Administration*.

— :22F: - Buy-In Indicator

BSSN: The Buy-in was not successful.

BSSP: The Buy-in was partially successful.

BSSY: The Buy-in was successful.

Optional Repetitive Subsequence B1 Linkages

— :22F: - Linkage Type Indicator

It is possible to change all three link indicators (AFTE, BEFO and WITH) with one modification instruction (UNLK or LINK instruction).

For details, please see *Annex B Guideline Settlement and Securities Account Administration*.

— :20C: - Reference

This field must contain the customer reference or T2S reference of the linked instruction.

Optional Repetitive Sequence C Additional Information

— :36B: - Quantity

In case of a partial release instruction this field must contain the quantity of securities to be released as nominal value or as number of units.

— :90B: - Buy-in Price

For this field only option B is allowed.

— :19A: - Cash Compensation Amount

This field must contain the cash compensation amount in case of an unsuccessful or partially successful buy-in transaction.

1.4.1.4 MT530 Examples

Modification of the Partial Settlement Indicator

For the settlement instruction with reference RZB01 partial execution is allowed.

:16R:GENL
:20C::SEME//RZBKDREF1
:23G:NEWM
:97A::SAFE//OCSD227200
:16S:GENL
:16R:REQD
:20C::PREV//RZB01
:22F::PRTL//PART
:16S:REQD

Modification of the Status Hold/Release

The instruction status is changed from released for settlement (NEWM) to on Hold (PREA).

:16R:GENL
:20C::SEME//RZBKDREF2
:23G:NEWM
:97A::SAFE//OCSD227200

:16S:GENL

:16R:REQD

:20C::PREV//RZB02

:22F::SETT//NPRE

:16S:REQD

Modification of a Priority

:16R:GENL

:20C::SEME//RZBKDREF3

:23G:NEWM

:97A::SAFE//OCSD227200

:16S:GENL

:16R:REQD

:20C::PREV//RZB03

:22F::PRIR//0003

:16S:REQD

Deletion of a Linkage

The linkage between instruction RZB04 and instruction RZB05 is deleted.

:16R:GENL

:20C::SEME//RZBKDREF4

:23G:NEWM

:97A::SAFE//OCSD227200

:16S:GENL

:16R:REQD

:20C::PREV//RZB04

:22F::LINK//UNLK

:16R:LINK

:22F::LINK//WITH

:20C::PREV//RZB05

:16S:LINK

:16S:REQD

Linking of Several Instructions

Instruction with reference RZB06 is linked to the instructions RZB07 and RZB08.

RZB06 shall be settled prior to instruction RZB07 and at the same time as instruction RZB08.

:16R:GENL

:20C::SEME//RZBKDREF5

:23G:NEWM

:97A::SAFE//OCSD227200

:16S:GENL
:16R:REQD
:20C::PREV//RZB06
:22F::LINK//LINK
:16R:LINK
:22F::LINK//BEFO
:20C::PREV//RZB07
:16S:LINK
:16R:LINK
:22F::LINK//WITH
:20C::PREV//RZB08
:16S:LINK
:16S:REQD

Modification of the Status Hold/Release for an instruction which have been created by an authorised party

The instruction status is changed from released for settlement (NEWM) to on Hold (PREA).

:16R:GENL
:20C::SEME//1S20180624-27
:23G:NEWM
:97A::SAFE//OCSD123400
:16S:GENL
:16R:REQD
:20C::RELA//1S20180624 (= PCTI reference from MT548)
:22F::SETT//NPRE
:16S:REQD

Partial release instruction

A part of a settlement instruction is released for settlement (status change from hold to released and information about the quantity of securities to be settled).

:16R:GENL
:20C::SEME//PARTREL1
:23G:NEWM
:97A::SAFE//OCSD111100
:16S:GENL
:16R:REQD
:20C::PREV//OCSD12345
:22F::SETT//YPRE
:16S:REQD
:16R:ADDINFO
:36B::SETT//UNIT/1000,
:16S:ADDINFO

Buy-In fully successful

Reporting of a fully successful buy-in of 1000 units of ISIN AT000BSP0004 at a price of 4.000,- EUR per unit

:16R:GENL
:20C::SEME//OEKBSD-20301-01
:23G:NEWM
:98C::PREP//20200604141359
:97A::SAFE//OCSD222100
:16S:GENL
:16R:REQD
:22F::BYIY//BSSY
:16S:REQD
:16R:ADDINFO
:35B:ISIN AT000BSP0004
:36B::SETT//UNIT/1000,
:90B::BYIY//ACTU/EUR4000,
:16S:ADDINFO

Buy-In partially successful

Reporting of a partially successful buy-in where 500 units of ISIN AT000BSP0004 were bought in at a price of 2.000,- EUR per unit. A cash compensation of 2.000,- EUR for the units that could not be bought in was also made.

:16R:GENL
:20C::SEME//OEKBSD-20301-02
:23G:NEWM
:98C::PREP//20200604141359
:97A::SAFE//OCSD222100
:16S:GENL
:16R:REQD
:22F::BYIY//BSSP
:16S:REQD
:16R:ADDINFO
:35B:ISIN AT000BSP0004
:36B::SETT//UNIT/500,
:90B::BYIY//ACTU/EUR2000,
:19A::BCAM//EUR2000,
:16S:ADDINFO

Buy-In unsuccessful

Reporting of an unsuccessful buy-in where a cash compensation of 5000,- EUR for the units of ISIN AT000BSP0004 that could not be bought in was made.

:16R:GENL
 :20C::SEME//OEKBSD-20301-03
 :23G:NEWM
 :98C::PREP//20200604141359
 :97A::SAFE//OCSD222100
 :16S:GENL
 :16R:REQD
 :22F::BYIY//BSSN
 :16S:REQD
 :16R:ADDINFO
 :35B:ISIN AT000BSP0004
 :19A::BCAM//EUR5000,
 :16S:ADDINFO

1.4.1.5 MT540 - Receive Free of Payment

MT540 is used for the receipt of securities free of payment (RFP).

1.4.1.5.1 Content

M/O	Tag	Field Name	Qualifier	Option	Format	Codes	Description
Mandatory Sequence A General Information							
M	:16R:	Start of Block			16c	GENL	
M	:20C:	Sender's Reference	SEME		:4!c//16x		Reference assigned by the sender to unambiguously identify the message
M	:23G:	Function of the Message			4!c	PREA	Message preadvicing a settlement instruction.
						NEWM	New message
						CANC	Message requesting the cancellation of a previously sent message.
O	:99B:	Number Count	SETT		:4!c//3!n	000-999	Sequential number of the instruction in a range of linked settlement instructions.

M/O	Tag	Field Name	Qualifier	Option	Format	Codes	Description
O	:99B:	Number Count	TOSE		:4!c//3!n	000-999	Total number of settlement instructions that are linked together.

Optional Repetitive Subsequence A1 Linkages

M	:16R:	Start of Block			16c	LINK	
O	:22F:	Linkage Type Indicator	LINK		:4!c/[8c]/4!c	AFTE	Indicates that the message is to be processed after the linked message.
						BEFO	Indicates that the message is to be processed before the linked message.
						WITH	Indicates that the message is to be processed with the linked message.
						INFO	Indicates that the messages are linked for information purposes only.
O	:13A:	Linked Transaction	LINK		:4!c//3!c		Message type number/message identifier of the message referenced in the linkage sequence.
M	:20C:	Reference	RELA		:4!c//16x		Related Message Reference
			PREV				Previous Message Reference
			PREA				Preadvice Message Reference
			POOL				Pool Reference
			COMM				Common Reference

M/O	Tag	Field Name	Qualifier	Option	Format	Codes	Description
			PCTI				Processor Transaction Identification
M	:16S:	End of Block			16c	LINK	
End of Subsequence A1 Linkages							
M	:16S:	End of Block			16c	GENL	
End of Sequence A General Information							
Mandatory Sequence B Trade Details							
M	:16R:	Start of Block			16c	TRADDET	
O	:94H:	Place of Clearing	CLEA		:4!c//4!a2!a2!c[3!c]		
O	:94B:	Place of Trade	TRAD		:4!c//4!c[/30x]	EXCH	Place of trade is a stock exchange
						OTCO	Place of trade is over the counter.
						PRIM	Place of trade is the primary market.
						SECM	Place of trade is the secondary market.
						VARI	Trade was executed on various places.
M	:98a:	Trade Date/Time	TRAD	A	:4!c//8!n		Date at which the trade was executed.
				C	:4!c//8!n6!n		Date and time at which the trade was executed.
M	:98A:	Settlement Date	SETT		:4!c//8!n		Date at which the financial instruments are to be delivered or received.
M	:35B:	Identification of the Financial Instrument			ISIN1!e12!c		"ISIN" followed by <Blank> and ISIN Code
					4*35x		Description of the financial instrument (optional)

M/O	Tag	Field Name	Qualifier	Option	Format	Codes	Description
O	:22F:	Priority Indicator	PRIR		:4!c//4!c	0003	High priority
						0004	Normal priority
O	:22F:	Trade Transaction Condition Indicator	TTCO		:4!c/[8c]/4!c	CCPN	Trade was executed cum coupon.
						XCPN	Trade was executed ex coupon.
O	:25D:	Status	MTCH		:4!c/[8c]/4!c	MACH	Instruction has been matched.
O	:70E:	Narrative	SPRO		:4!c//10*35x		Provides additional settlement processing information which cannot be included within the structured fields of the message.
M	:16S:	End of Block			16c	TRADDET	

End of Sequence B Trade Details

Mandatory Sequence C Financial Instrument/Account

M	:16R:	Start of Block			16c	FIAC	
M	:36B:	Quantity of Financial Instrument to be Settled	SETT		:4!c//4!c/15d	FAMT	Face amount
						UNIT	Unit number
M	:97A:	Safekeeping Account	SAFE		:4!c//35x		OeKB CSD's securities account number of the customer
M	:16S:	End of Block			16c	FIAC	

End of Sequence C Financial Instrument/Account

Mandatory Sequence E Settlement Details

M	:16R:	Start of Block			16c	SETDET	
---	-------	----------------	--	--	-----	--------	--

M/O	Tag	Field Name	Qualifier	Option	Format	Codes	Description
M	:22F:	Type of Settlement Transaction	SETR		:4!c/[8!c]/4!c	TRAD	Specifies underlying information regarding the type of settlement transaction
					:4!c/COEX/4!c	AUTO	Auto-collateralisation, in case of an Intra-day Restriction on the eligible ISIN
O	:22F:	Settlement Transaction Condition Indicator	STCO		:4!c/[8c]/4!c	NPAR	Partial settlement is not allowed.
						PART	Partial settlement is allowed.
						NOMC	No market claim should be automatically generated.
					:4!c/COEX/4!c	PARQ	Partial Settlement is Allowed with Minimum Quantity
						PARC	Partial Settlement is Allowed with Minimum Cash Value
		:4!c/REGL/4!c	BSSP	Instruction Resulting from Partially Successful Buy-In			
O	:22F:	Securities Sub-balance Type Indicator	SSBT		:4!c/[8c]/4!c	EEUR	Earmarking for autocoll.
						EAR <i>n</i>	Other earmarking
O	:22F:	Beneficial Ownership Indicator	BENE		:4!c/[8c]/4!c	NBEN	No Change of Beneficial Ownership (NCBO)

M/O	Tag	Field Name	Qualifier	Option	Format	Codes	Description
						YBEN	Change of Beneficial Ownership (CBO)
Mandatory Repetitive Subsequence E1 Settlement Parties							
M	:16R:	Start of Block			16c	SETPRTY	
M	:95P:	Place of Settlement	PSET		:4!c//4!a2!a2!c[3!c]		Place of settlement (depository)
M	:16S:	End of Block			16c	SETPRTY	
M	:16R:	Start of Block			16c	SETPRTY	
M	:95P:	Delivering Agent	DEAG		:4!c//4!a2!a2!c[3!c]		Delivering party that interacts with the place of settlement.
(M)	:97A:	Safekeeping Account	SAFE		4!c//35x		Counterparty's securities acc. number
M	:16S:	End of Block			16c	SETPRTY	
O	:16R:	Start of Block			16c	SETPRTY	
O	:95a:	Deliverer's Intermediary 2	DEI2	P	:4!c//4!a2!a2!c[3!c]		Party that interacts with the deliverer's intermediary 1
				R	:4!c/8!c/34x		
				Q	:4!c//4*35x		
O	:97A:	Safekeeping Account	SAFE		:4!c//35x		No. of securities acc. held with the party one step higher in the chain
O	:16S:	End of Block			16c	SETPRTY	
O	:16R:	Start of Block			16c	SETPRTY	
O	:95a:	Deliverer's Intermediary 1	DEI1	P	:4!c//4!a2!a2!c[3!c]		Party that interacts with the delivering agent.
				R	:4!c/8!c/34x		
				Q	:4!c//4*35x		
O	:97A:	Safekeeping Account	SAFE		:4!c//35x		No. of securities acc. held with the party one step higher in the chain
O	:16S:	End of Block			16c	SETPRTY	
O	:16R:	Start of Block			16c	SETPRTY	

M/O	Tag	Field Name	Qualifier	Option	Format	Codes	Description
O	:95a:	Receiver's Custodian	DECU	P	:4!c//4!a2!a2!c[3!c]		Party that interacts with the delivering agent unless intermediaries exist
				R	:4!c/8!c/34x		
				Q	:4!c//4*35x		
O	:97A:	Safekeeping Account	SAFE		:4!c//35x		No. of securities acc. held with the party one step higher in the chain
O	:16S:	End of Block			16c	SETPRTY	
O	:16R:	Start of Block			16c	SETPRTY	
O	:95a:	Seller	SELL	P	:4!c//4!a2!a2!c[3!c]		Party that delivers the financial instrument
				R	:4!c/8!c/34x		
				Q	:4!c//4*35x		
O	:97A:	Safekeeping Account	SAFE		:4!c//35x		No. of securities acc. held with the party one step higher in the chain
O	:16S:	End of Block			16c	SETPRTY	
O	:16R:	Start of Block			16c	SETPRTY	
O	:95P:	Receiving Agent	REAG		:4!c//4!a2!a2!c[3!c]		Receiving party that interacts with the place of settlement.
O	:16S:	End of Block			16c	SETPRTY	
O	:16R:	Start of Block			16c	SETPRTY	
O	:95a:	Receiver's Intermediary 2	REI2	P	:4!c//4!a2!a2!c[3!c]		Party that interacts with the receiver's intermediary 1
				R	:4!c/8!c/34x		
				Q	:4!c//4*35x		
O	:97A:	Safekeeping Account	SAFE		:4!c//35x		No. of safekeeping acc. held with the party one step higher in the chain
O	:16S:	End of Block			16c	SETPRTY	
O	:16R:	Start of Block			16c	SETPRTY	
O	:95a:		REI1	P	:4!c//4!a2!a2!c[3!c]		

M/O	Tag	Field Name	Qualifier	Option	Format	Codes	Description
		Receiver's Intermediary 1		R	:4!c/8!c/34x		Party that interacts with the receiving agent
				Q	:4!c//4*35x		
O	:97A:	Safekeeping Account	SAFE		:4!c//35x		No. of securities acc. held with the party one step higher in the chain
O	:16S:	End of Block			16c	SETPRTY	
O	:16R:	Start of Block			16c	SETPRTY	
O	:95a:	Receiver's Custodian	RECU	P	:4!c//4!a2!a2!c[3!c]		Party that interacts with the receiving agent unless intermediaries exist
				R	:4!c/8!c/34x		
				Q	:4!c//4*35x		
O	:97A:	Safekeeping Account	SAFE		:4!c//35x		No. of securities acc. held with the party one step higher in the chain
O	:16S:	End of Block			16c	SETPRTY	
O	:16R:	Start of Block			16c	SETPRTY	
O	:95a:	Buyer	BUYR	P	:4!c//4!a2!a2!c[3!c]		Party that receives the financial instrument
				R	:4!c/8!c/34x		
				Q	:4!c//4*35x		
O	:97A:	Safekeeping Account	SAFE		:4!c//35x		No. of securities acc. held with the party one step higher in the chain
M	:16S:	End of Block			16c	SETPRTY	
End of Subsequence E1 Settlement Parties							
M	:16S:	End of Block			16c	SETDET	
End of Sequence E Settlement Details							

1.4.1.5.2 Explanation of the SWIFT Fields

Sequence A - General Information

— :23G: - Function of the Message

The PREA/NEWM function will be replaced with Hold/Release in T2S. The PREA/NEWM function will remain available for submitting instructions in ISO 15022 format.

PREA: New instruction with On Hold = yes; The position is not released for settlement.

NEWM: New instruction with On Hold = no; The position is released for settlement. After a NEWM was submitted an MT530 or the Settlement Client must be used to change the On Hold setting.

CANC: Cancellation of the instruction.

— :99B: - Number Count

Instructions with a pool reference must include a pool counter indicating the total number of linked instructions.

SETT: Mandatory if the pool reference in the Optional Repetitive Subsequence A1 Linkages is filled.

TOSE: Mandatory if the pool reference in the Optional Repetitive Subsequence A1 Linkages is filled.

External-CSD Settlement: Linking of instructions is not possible.

— :22F: - Linkage Type Indicator

AFTE: Current instruction will be settled AFTER the linked-to instruction.

BEFO: Current instruction will be settled BEFORE the linked-to instruction.

WITH: Current instruction will be settled together WITH the linked-to instruction.

INFO: The LINK is added for informational purposes only and has no effects on the processing.

External-CSD Settlement: Linking of instructions is not possible.

Optional Repetitive Subsequence A1 Linkages

— :20C: - Reference

RELA: Customer reference of the referenced instruction (if A1:22F:LINK exists in this subsequence).

PREV: Customer reference of the instruction to be cancelled (in case of A:23G:CANC).

PREA: Customer reference of the instruction with PREA function (in case of A:23G:NEWM).

POOL: A pool reference can be used to link more than two instructions. It is a collective reference for a set of settlement instructions which must be settled collectively *"all-or-none"*.

COMM: Unique reference agreed between two counterparties to identify the instruction.

PCTI: In case of cancellation orders for instructions where the instructing party is different from the instructing party of the instruction being cancelled, this field has to contain the PCTI reference from the MT 548 status message.

- Instructions, which have been created by the OeKB CSD as instructing party (e.g. market claim or transformation)
- Instructions, which have been created by an authorised party but which are cancelled by the securities account owner

In addition the field :20C::PREV must be filled in with NONREF, because according to ISO 15022 SWIFT standard field :20C::PREV must be present, if field :23G: is CANC.

Mandatory Sequence B Trade Details

— :98A: - Date

SETT: It is no longer possible to specify the exact time on the settlement day.

— :22F: - Priority Indicator

PRIR: When prioritising instructions it is possible to choose from 2 priority levels: High Priority (0003) and Normal Priority (0004). For details, please see *Annex 8 Guideline Settlement and Securities Account Administration*.

External-CSD Settlement: Prioritising of instructions is not possible.

— :22F: - Trade Transaction Condition Indicator

TTCO: This qualifier specifies whether the security is delivered with (CCPN – Cum Coupon) or without (XCPN – Ex Coupon) coupon (additional matching field).

External-CSD Settlement: This indicator is not used.

Mandatory Sequence C Financial Instrument/Account

— :97A: Safekeeping Account

The securities account number can be specified in the old format (e.g. 123400) or in the new format "OCSD + existing securities account number" (e.g. OCSD123400).

Mandatory Sequence E Settlement Details

— :22F: -Settlement Transaction Condition Indicator

NPAR: Partial settlement of an instruction is not allowed.

PART: Partial settlement of an instruction is allowed.

PARQ: Partial Settlement is allowed with Minimum Quantity

PARC: Partial Settlement is allowed with Minimum Cash Value

NOMC: Opt-out indicator (additional matching field).

BSSP: Instruction Resulting from Partially Successful Buy-In. If the matching instruction is also instructed with this Settlement Transaction Condition both instructions will be exempt from Late Matching penalty fees. It is not a matching field.

For details, please see *Annex 8 Guideline Settlement and Securities Account Administration*.

External-CSD Settlement: Partial settlement is not possible.

— :22F: - Securities Sub-balance Type Indicator

SSBT: For this qualifier the use of Data Source Scheme "RT" (:4!c/RT/4!c) is compulsory.

For the code EARn the rule "1<=n<=9", e.g. EAR1, EAR2,....., EAR9 applies.

Mandatory Repetitive Subsequence E1 Settlement Parties

— :95P: - Place of Settlement

PSET: For identification the BIC of the counterparty's CSD (depository) is used as the sole reference.

— :95P: - Delivering Agent

This field is used to identify the counterparty using the BIC.

— :97A: - Safekeeping Account

This field is optional. It is not considered for intra-CSD and cross-CSD settlement.

For transaction type external-CSD settlement this field must contain the securities account number as at present.

— :95a: - Receiver's Intermediary 2/Receiver's Intermediary 1/Receiving Custodian/ Buyer

It is possible to send all 5 parties (incl. DEAG). Please note, however, that except in the case of DEAG the following sequence must be observed for the parties: DEAG, DEI2, DEI1, DECU, SELL.

It is possible to shorten the chain, e.g. only SELL or only DEI1, DECU, SELL but the sequence must be observed in all cases.

— :95a: - Deliverer's Intermediary 2/Deliverer's Intermediary 1/Deliverer's Custodian/ Seller

Aside from the optional REAG, 4 additional parties can be specified on the deliverer side. For these 4 additional parties the following sequence must be observed: REI2, REI1, RECU, BUYR.

It is possible to shorten the chain, e.g. only BUYR or only REI1, RECU, BUYR but the sequence must be observed in all cases.

1.4.1.5.3 MT540 Examples

Transaction Type Intra-CSD Settlement

Transfer of an AT ISIN between two OeKB CSD customers free of payment.

— The instruction was submitted by the OeKB CSD customer with securities account number OCSD227200.

— The counterparty is the OeKB CSD customer with BIC BKAUATWWXXX.

:16R:GENL

:20C::SEME//00001

:23G:NEWM
:16S:GENL
:16R:TRADEDET
:98A::TRAD//20131025
:98A::SETT//20131030
:35B:ISIN AT000BSP0001
BEISPIEL 1 AG
:16S:TRADEDET
:16R:FIAC
:36B::SETT//UNIT/100,
:97A::SAFE//OCSD227200
:16S:FIAC
:16R:SETDET
:22F::SETR//TRAD
:16R:SETPRTY
:95P::PSET//OCSDATWWXXX
:16S:SETPRTY
:16R:SETPRTY
:95P::DEAG//BKAUATWWXXX
:16S:SETPRTY
:16S:SETDET

Counterparty with Securities Account at Clearstream Banking Luxembourg

:16R:GENL
:20C::SEME//9873654
:23G:PREA
:16S:GENL
:16R:TRADEDET
:98A::SETT//20190124
:98A::TRAD//20190122
:35B:ISIN AT0000743059
OMV AG AKT. O.N.
:22F::PRIR//0004
:16S:TRADEDET
:16R:FIAC
:36B::SETT//UNIT/5000,
:97A::SAFE//222100
:16S:FIAC
:16R:SETDET
:22F::SETR//TRAD
:22F::CASY//NETS
:16R:SETPRTY
:95P::REAG//CEDELULLXXX

:16S:SETPRTY

:16R:SETPRTY

:95Q:BUYR//ABCDESSXXX

:97A::SAFE//22668

:16S:SETPRTY

:16R:SETPRTY

:95P::PSET//DAKVDEFFXXX

:16S:SETPRTY

:16R:AMT

:19A::SETT//EUR215918,52

:16S:AMT

:16S:SETDET

Transaction Type Intra-CSD Settlement with Earmarking

Transfer of an AT ISIN between two OeKB CSD customers free of payment. The delivered position is flagged "earmarked".

- The instruction was submitted by the OeKB CSD customer with securities account number OCSD227600
- The counterparty is the OeKB CSD customer with BIC BKAUATWWXXX.

:16R:GENL

:20C::SEME//00002

:23G:NEWM

:16S:GENL

:16R:TRADEDET

:98A::TRAD//20140630

:98A::SETT//20140701

:35B:ISIN AT0000A105W3

:16S:TRADEDET

:16R:FIAC

:36B::SETT//UNIT/100000,

:97A::SAFE//OCSD227600

:16S:FIAC

:16R:SETDET

:22F::SSBT/RT/EEUR

:22F::SETR//TRAD

:16R:SETPRTY

:95P::PSET//OCSDATWWXXX

:16S:SETPRTY

:16R:SETPRTY

:95P::DEAG//BKAUATWWXXX

:16S:SETPRTY

:16R:SETPRTY

:95Q::SELL//Generali Bank

:16S:SETPRTY

:16S:SETDET

Transaction Type External

Counterparty with Securities Account at CBL (Standard External)

:16R:GENL

:20C::SEME//2813240000042012

:23G:NEWM

:16S:GENL

:16R:TRADEDET

:98A::SETT//20170207

:98A::TRAD//20170206

:35B:ISIN XS0997941355

4,125 K+S AKTIENGESELLSCHAFT

EO-ANL.F.6.12.2021(21) 6.12.

:16S:TRADEDET

:16R:FIAC

:36B::SETT//FAMT/100000,

:97A::SAFE//OCSD247600

:16S:FIAC

:16R:SETDET

:22F::SETR//TRAD

:16R:SETPRTY

:95P::PSET//CEDELULLXXX

:16S:SETPRTY

:16R:SETPRTY

:95P::DEAG//FMBKDEMMXXX

:97A::SAFE//62013

:16S:SETPRTY

:16S:SETDET

Counterparty with Securities Account at Euroclear Bank (Bridge)

:16R:GENL

:20C::SEME//57709220170208

:23G:NEWM

:98C::PREP//20170208105608

:16S:GENL

:16R:TRADEDET

:98A::TRAD//20170209

:98A::SETT//20170209

:35B:ISIN XS0629626663

OMV FLR MTN 11/UND

:16S:TRADEDET
:16R:FIAC
:36B::SETT//FAMT/15000,
:97A::SAFE//OCSD225100
:16S:FIAC
:16R:SETDET
:22F::SETR//TRAD
:22F::RTGS//YRTG
:16R:SETPRTY
:95P::PSET//MGTCBEBEXXX
:16S:SETPRTY
:16R:SETPRTY
:95P::DEAG//OBKLAT2LXXX
:97A::SAFE//92483
:16S:SETPRTY

Transaction Type Cross-CSD Settlement

Counterparty with Securities Account at Euroclear Nederland (ISIN JE00B3DCF752 ATRIUM EUROPE)

:16R:GENL
:20C::SEME//208053
:23G:NEWM
:16S:GENL
:16R:TRADEDET
:98A::SETT//20170220
:98A::TRAD//20170220
:35B:ISIN JE00B3DCF752
ATRIUM EUROPE.R.E.
:16S:TRADEDET
:16R:FIAC
:36B::SETT//UNIT/100,
:97A::SAFE//OCSD222100
:16S:FIAC
:16R:SETDET
:22F::SETR//TRAD
:16R:SETPRTY
:95P::PSET//NECINL2AXXX
:16S:SETPRTY
:16R:SETPRTY
:95P::REAG//BKAUATWWXXX
:16S:SETPRTY
:16R:SETPRTY
:95P::DEAG//MGTCBEBEECL
:16S:SETPRTY

:16R:SETPRTY
:95P::SELL//CSFBGB2LXXX
:97A::SAFE//93827

Counterparty with Securities Account at Monte Titoli (AT-ISIN)

:16R:GENL
:20C::SEME//123456
:23G:NEWM
:16S:GENL
:16R:TRADEDET
:98A::SETT//20170208
:98A::TRAD//20170208
:35B:ISIN AT0000720008
TELEKOM AUSTRIA AG
INHABERAKTIEN O.N.
:16S:TRADEDET
:16R:FIAC
:36B::SETT//UNIT/1,
:97A::SAFE//OCSD243900
:16S:FIAC
:16R:SETDET
:22F::SETR//TRAD
:22F::STCO//PART
:16R:SETPRTY
:95P::DEAG//SELBIT22XXX
:16S:SETPRTY
:16R:SETPRTY
:95P::BUYR//SELBIT22XXX
:16S:SETPRTY
:16R:SETPRTY
:95P::PSET//MOTIITMMXXX
:16S:SETPRTY
:16S:SETDET

Counterparty with Securities Account at CBF

:16R:GENL
:20C::SEME//11335577ABC
:23G:NEWM
:16S:GENL
:16R:TRADEDET
:98A::TRAD//20190523
:98A::SETT//20190527

:16R:GENL
:35B:ISIN DE0007100000
DAIMLER AG NA O.N.
:16S:TRADDET
:16R:FIAC
:36B::SETT//UNIT/42,
:97A::SAFE//OCSD273700
:16S:FIAC
:16R:SETDET
:22F::SETR//TRAD
:22F::STCO//NPAR
:16R:SETPRTY
:95P::PSET//DAKVDEFFXXX
:16S:SETPRTY
:16R:SETPRTY
:95P::DEAG//TUBDDEDDXXX
:16S:SETPRTY
:16R:SETPRTY
:95P::SELL//TUBDDEDDXXX
:97A::SAFE//4043
:16S:SETPRTY
:16S:SETDET

Cancellation order for a market claim instruction instructed by OeKB CSD

:16R:GENL
:20C::SEME//20170509CANC1
:23G:CANC
:16R:LINK
:20C::PREV//NONREF
:16S:LINK
:16R:LINK
:20C::PCTI//CS000TEST06 (= *PCTI reference from MT548 market claim*)
:16S:LINK
:16S:GENL
:16R:TRADDET
:98A::TRAD//20170502
:98A::SETT//20170509
:35B:ISIN AT0000TEST04
:16S:TRADDET
:16R:FIAC
:36B::SETT//UNIT/10,

:16R:GENL
:97A::SAFE//OCSD471100
:16S:FIAC
:16R:SETDET
:22F::SETR//CLAI
:16R:SETPRTY
:95P::PSET//OCSDATWWXXX
:16S:SETPRTY
:16R:SETPRTY
:95P::DEAG//ABCDDEFFXXX
:16S:SETPRTY
:16S:SETDET

Cancellation order from the securities account owner for an instruction instructed by an authorised party

- Instructing BIC of authorised party of the instruction being cancelled: ABCDATWWXXX
- Instructing BIC of the securities account owner and sender of the cancellation order: WXYZATWWXXX

:16R:GENL
:20C::SEME//20170509CANC2
:23G:CANC
:16R:LINK
:20C::PREV//NONREF
:16S:LINK
:16R:LINK
:20C::PCTI//OCSD000075987 (= PCTI reference from MT548)
:16S:LINK
:16S:GENL
:16R:TRADDET
:98A::TRAD//20170502
:98A::SETT//20170509
:35B:ISIN AT0000TEST04
:16S:TRADDET
:16R:FIAC
:36B::SETT//UNIT/10,
:97A::SAFE//OCSD471100
:16S:FIAC
:16R:SETDET
:22F::SETR//TRAD
:16R:SETPRTY
:95P::PSET//OCSDATWWXXX
:16S:SETPRTY
:16R:SETPRTY
:95P::DEAG//ABCDDEFFXXX
:16S:SETPRTY

:16R:GENL

:16S:SETDET

1.4.1.6 MT541 – Receive Against Payment

MT541 is used for receipt instructions versus payment (RVP), for receipt with payment (RWP) and for payments free of receipt (PFRD) and Credits free of receipt (PFRC). MT541 cannot be used for External Instructions.

Multicurrency settlement instructions: RWP and PFRD and PFRC are not used.

1.4.1.6.1 Content

M/O	Tag	Field Name	Qualifier	Option	Format	Codes	Description
Mandatory Sequence A General Information							
M	:16R:	Start of Block			16c	GENL	
M	:20C:	Sender's Reference	SEME		:4!c//16x		Reference assigned by the sender to unambiguously identify the message
M	:23G:	Function of the Message			4!c	PREA NEWM CANC	Message preadvising a settlement instruction. New message Message requesting the cancellation of a previously sent message.
O	:99B:	Number Count	SETT		:4!c//3!n	000-999	Sequential number of the instruction in a range of linked settlement instructions.
O	:99B:	Number Count	TOSE		:4!c//3!n	000-999	Total number of settlement instructions that are linked together.
Optional Repetitive Subsequence A1 Linkages							
M	:16R:	Start of Block			16c	LINK	
O	:22F:	Linkage Type Indicator	LINK		:4!c/[8c]/4!c	AFTE	Indicates that the message is to be processed after the linked message.

M/O	Tag	Field Name	Qualifier	Option	Format	Codes	Description
						BEFO	Indicates that the message is to be processed before the linked message.
						WITH	Indicates that the message is to be processed with the linked message.
						INFO	Indicates that the messages are linked for information purposes only.
O	:13A:	Linked Transaction	LINK		:4!c//3!c		Message type number/message identifier of the message referenced in the linkage sequence.
M	:20C:	Reference	RELA		:4!c//16x		Related Message Reference
			PREV				Previous Message Reference
			PREA				Preadvice Message Reference
			POOL				Pool Reference
			COMM				Common Reference
			PCTI				Processor Transaction Identification
M	:16S:	End of Block			16c	LINK	
End of Subsequence A1 Linkages							
M	:16S:	End of Block			16c	GENL	
End of Sequence A General Information							
Mandatory Sequence B Trade Details							
M	:16R:	Start of Block			16c	TRADDET	
O	:94H:	Place of Clearing	CLEA		:4!c//4!a2!a2!c[3!c]		
O	:94B:	Place of Trade	TRAD		:4!c//4!c[/30x]	EXCH	Place of trade is a stock exchange
						OTCO	Place of trade is over the counter.

M/O	Tag	Field Name	Qualifier	Option	Format	Codes	Description
						PRIM	Place of trade is the primary market.
						SECM	Place of trade is the secondary market.
						VARI	Trade was executed on various places.
M	:98a:	Trade Date/Time	TRAD	A	:4!c//8!n		Date at which the trade was executed.
				C	:4!c//8!n6!n		Date and time at which the trade was executed.
M	:98A:	Settlement Date	SETT		:4!c//8!n		Date at which the financial instruments are to be delivered or received.
M	:35B:	Identification of the Financial Instrument			ISIN!1e12!c 4*35x		"ISIN" followed by <Blank> and ISIN Code Description of the financial instrument (optional)
O	:22F:	Priority Indicator	PRIR		:4!c//4!c	0003 0004	High priority Normal priority
O	:22F:	Trade Transaction Condition Indicator	TTCO		:4!c/[8c]/4!c	CCPN XCPN	Trade was executed cum coupon. Trade was executed ex coupon.
O	:25D:	Status	MTCH		:4!c/[8c]/4!c	MACH	Instruction has been matched.
O	:70E:	Narrative	SPRO		:4!c//10*35x		Provides additional settlement processing information which cannot be included within the structured fields of the message.
M	:16S:	End of Block			16c	TRADDET	
End of Sequence B Trade Details							
Mandatory Sequence C Financial Instrument/Account							
M	:16R:	Start of Block			16c	FIAC	
M	:36B:		SETT		:4!c//4!c/15d	FAMT	Face amount

M/O	Tag	Field Name	Qualifier	Option	Format	Codes	Description
		Quantity of Financial Instrument to be Settled				UNIT	Unit number
M	:97A:	Safekeeping Account	SAFE		:4!c//35x		OeKB CSD's securities account number of the customer
O	:97A:	Cash Account	CASH		:4!c//35x		Account in which cash is maintained
M	:16S:	End of Block			16c	FIAC	
End of Sequence C Financial Instrument/Account							
Mandatory Sequence E Settlement Details							
M	:16R:	Start of Block			16c	SETDET	
M	:22F:	Type of Settlement Transaction	SETR		:4!c/[8!c]/4!c	TRAD	Specifies underlying information regarding the type of settlement transaction
					:4!c/COEX/4!c	AUTO	Auto-collateralisation, in case of an Intra-day Restriction on the eligible ISIN
O	:22F:	Settlement Transaction Condition Indicator	STCO		:4!c/[8!c]/4!c	NPAR	Partial settlement is not allowed.
						PART	Partial settlement is allowed.
						NOMC	No market claim should be automatically generated.
					:4!c/COEX/4!c	PARQ	Partial Settlement is Allowed with Minimum Quantity
						PARC	Partial Settlement is Allowed with Minimum Cash Value
					:4!c/REGL/4!c	BSSP	Instruction Resulting from Partially Successful Buy-In
O	:22F:	Securities Sub-balance Type Indicator	SSBT		:4!c/[8!c]/4!c	EEUR	Earmarking for autocoll.
						EARn	Other earmarking

M/O	Tag	Field Name	Qualifier	Option	Format	Codes	Description
O	:22F:	Beneficial Ownership Indicator	BENE		:4!c/[8c]/4!c	NBEN	No Change of Beneficial Ownership (NCBO)
						YBEN	Change of Beneficial Ownership (CBO)

Mandatory Repetitive Subsequence E1 Settlement Parties

M	:16R:	Start of Block			16c	SETPRTY	
M	:95P:	Place of Settlement	PSET		:4!c//4!a2!a2!c[3!c]		Place of settlement (depository)
M	:16S:	End of Block			16c	SETPRTY	
M	:16R:	Start of Block			16c	SETPRTY	
M	:95P:	Delivering Agent	DEAG		:4!c//4!a2!a2!c[3!c]		Delivering party that interacts with the place of settlement.
(M)	:97A:	Safekeeping Account	SAFE		4!c//35x		Counterparty's securities acc. number
M	:16S:	End of Block			16c	SETPRTY	
O	:16R:	Start of Block			16c	SETPRTY	
O	:95a:	Deliverer's Intermediary 2	DEI2	P	:4!c//4!a2!a2!c[3!c]		Party that interacts with the deliverer's intermediary 1
				R	:4!c/8!c/34x		
				Q	:4!c//4*35x		
O	:97A:	Safekeeping Account	SAFE		:4!c//35x		No. of securities acc. held with the party one step higher in the chain
O	:16S:	End of Block			16c	SETPRTY	
O	:16R:	Start of Block			16c	SETPRTY	
O	:95a:	Deliverer's Intermediary 1	DEI1	P	:4!c//4!a2!a2!c[3!c]		Party that interacts with the delivering agent.
				R	:4!c/8!c/34x		
				Q	:4!c//4*35x		
O	:97A:	Safekeeping Account	SAFE		:4!c//35x		No. of securities acc. held with the party one step higher in the chain
O	:16S:	End of Block			16c	SETPRTY	

M/O	Tag	Field Name	Qualifier	Option	Format	Codes	Description
O	:16R:	Start of Block			16c	SETPRTY	
O	:95a:	Receiver's Custodian	DECU	P	:4!c//4!a2!a2!c[3!c]		Party that interacts with the delivering agent unless intermediaries exist
				R	:4!c/8!c/34x		
				Q	:4!c//4*35x		
O	:97A:	Safekeeping Account	SAFE		:4!c//35x		No. of securities acc. held with the party one step higher in the chain
O	:16S:	End of Block			16c	SETPRTY	
O	:16R:	Start of Block			16c	SETPRTY	
O	:95a:	Seller	SELL	P	:4!c//4!a2!a2!c[3!c]		Party that delivers the financial instrument
				R	:4!c/8!c/34x		
				Q	:4!c//4*35x		
O	:97A:	Safekeeping Account	SAFE		:4!c//35x		No. of securities acc. held with the party one step higher in the chain
O	:16S:	End of Block			16c	SETPRTY	
O	:16R:	Start of Block			16c	SETPRTY	
O	:95P:	Receiving Agent	REAG		:4!c//4!a2!a2!c[3!c]		Receiving party that interacts with the place of settlement.
O	:16S:	End of Block			16c	SETPRTY	
O	:16R:	Start of Block			16c	SETPRTY	
O	:95a:	Receiver's Intermediary 2	REI2	P	:4!c//4!a2!a2!c[3!c]		Party that interacts with the receiver's intermediary 1
				R	:4!c/8!c/34x		
				Q	:4!c//4*35x		
O	:97A:	Safekeeping Account	SAFE		:4!c//35x		No. of securities acc. held with the party one step higher in the chain
O	:16S:	End of Block			16c	SETPRTY	
O	:16R:	Start of Block			16c	SETPRTY	
O	:95a:		REI1	P	:4!c//4!a2!a2!c[3!c]		

M/O	Tag	Field Name	Qualifier	Option	Format	Codes	Description
		Receiver's Intermediary 1		R	:4!c/8!c/34x		Party that interacts with the receiving agent
				Q	:4!c//4*35x		
O	:97A:	Safekeeping Account	SAFE		:4!c//35x		No. of securities acc. held with the party one step higher in the chain
O	:16S:	End of Block			16c	SETPRTY	
O	:16R:	Start of Block			16c	SETPRTY	
O	:95a:	Receiver's Custodian	RECU	P	:4!c//4!a2!a2!c[3!c]		Party that interacts with the receiving agent unless intermediaries exist
				R	:4!c/8!c/34x		
				Q	:4!c//4*35x		
O	:97A:	Safekeeping Account	SAFE		:4!c//35x		No. of securities acc. held with the party one step higher in the chain
O	:16S:	End of Block			16c	SETPRTY	
O	:16R:	Start of Block			16c	SETPRTY	
O	:95a:	Buyer	BUYR	P	:4!c//4!a2!a2!c[3!c]		Party that receives the financial instrument
				R	:4!c/8!c/34x		
				Q	:4!c//4*35x		
O	:97A:	Safekeeping Account	SAFE		:4!c//35x		No. of securities acc. held with the party one step higher in the chain
M	:16S:	End of Block			16c	SETPRTY	
End of Subsequence E1 Settlement Parties							
Mandatory Repetitive Subsequence E3 Amount							
M	:16R:	Start of Block			16c	AMT	
M	:19A:	Settlement Amount	SETT		:4!c//[N]3!a15d		ISO-Currency code followed by cash amount
M	:16S:	End of Block			16c	AMT	
End of Subsequence E3 Amount							
M	:16S:	End of Block			16c	SETDET	

M/O	Tag	Field Name	Qualifier	Option	Format	Codes	Description
End of Sequence E Settlement Details							

1.4.1.6.2 Explanation of the SWIFT Fields

Sequence A - General Information

— :23G: - Function of the Message

The PREA/NEWM function will be replaced with Hold/Release in T2S. The PREA/NEWM function will remain available for submitting instructions in ISO 15022 format.

PREA: New instruction with On Hold = yes; The position is not released for settlement.

NEWM: New instruction with On Hold = no; The position is released for settlement. After a NEWM was submitted an MT530 or the Settlement Client must be used to change the On Hold setting.

CANC: Cancellation of the instruction.

— :99B: - Number Count

Instructions with a pool reference must include a pool counter indicating the total number of linked instructions.

SETT: Mandatory if the pool reference in the Optional Repetitive Subsequence A1 Linkages is filled.

TOSE: Mandatory if the pool reference in the Optional Repetitive Subsequence A1 Linkages is filled.

External-CSD Settlement and multicurrency settlement instructions: Linking of instructions is not possible.

— :22F: - Linkage Type Indicator

AFTE: Current instruction will be settled AFTER the linked-to instruction.

BEFO: Current instruction will be settled BEFORE the linked-to instruction.

WITH: Current instruction will be settled together WITH the linked-to instruction.

INFO: The LINK is added for informational purposes only and has no effects on the processing.

External-CSD Settlement and multicurrency settlement instructions: Linking of instructions is not possible.

Optional Repetitive Subsequence A1 Linkages

— :20C: - Reference

RELA: Customer reference of the referenced instruction (if A1:22F:LINK exists in this subsequence).

PREV: Customer reference of the instruction to be cancelled (in case of A:23G:CANC).

PREA: Customer reference of the instruction with PREA function (in case of A:23G:NEWM).

POOL: A pool reference can be used to link more than two instructions. It is a collective reference for a set of settlement instructions which must be settled collectively *"all-or-none"*.

COMM: Unique reference agreed between two counterparties to identify the instruction.

PCTI: In case of cancellation orders for instructions where the instructing party is different from the instructing party of the instruction being cancelled, this field has to contain the PCTI reference from the MT 548 status message.

- Instructions, which have been created by the OeKB CSD as instructing party (e.g. market claim or transformation)
- Instructions, which have been created by an authorised party but which are cancelled by the securities account owner

In addition the field :20C::PREV must be filled in with NONREF, because according to ISO 15022 SWIFT standard field :20C::PREV must be present, if field :23G: is CANC.

Mandatory Sequence B Trade Details

— :98A: - Date/Time

SETT: It is no longer possible to specify the exact time on the settlement day.

— :22F: - Priority Indicator

PRIR: When prioritising instructions it is possible to choose from 2 priority levels: High Priority (0003) and Normal Priority (0004). For details, please see *Annex 8 Guideline Settlement and Securities Account Administration*.

External-CSD Settlement: Prioritising of instructions is not possible.

— :22F: - Trade Transaction Condition Indicator

TTCO: This qualifier specifies whether the security is delivered with (CCPN – Cum Coupon) or without (XCPN – Ex Coupon) coupon (additional matching field).

External-CSD Settlement: This indicator is not used.

Mandatory Sequence C Financial Instrument/Account

— :36B: - Quantity

PFRD or PFRC: For payments or credits without delivery this field must be filled with "0".

— :97A: Safekeeping Account

The securities account number can be specified in the old format (e.g. 123400) or in the new format "OCSD + existing securities account number" (e.g. OCSD123400).

— :97A: - Cash Account

A safekeeping account can have assigned several DCAs (Dedicated Cash Account) in T2S. One of them is flagged as the default DCA. To use a different DCA than the default DCA for an instruction this field must contain the corresponding DCA.

In case of multicurrency settlement instructions cash settlement is carried out on multicurrency accounts (commercial bank cash accounts) held with OeKB. For each currency a securities account has assigned a default account, which is used for multicurrency instructions.

Mandatory Sequence E Settlement Details

— :22F: - Settlement Transaction Condition Indicator

NPAR: Partial settlement of an instruction is not allowed.

PART: Partial settlement of an instruction is allowed.

PARQ: Partial Settlement is allowed with Minimum Quantity

PARC: Partial Settlement is allowed with Minimum Cash Value

NOMC: Opt-out indicator (additional matching field).

BSSP: Instruction Resulting from Partially Successful Buy-In. If the matching instruction is also instructed with this Settlement Transaction Condition both instructions will be exempt from Late Matching penalty fees. It is not a matching field.

For details, please see *Annex 8 Guideline Settlement and Securities Account Administration*.

External-CSD Settlement and multicurrency instructions: Partial settlement is not possible.

— :22F: - Securities Sub-balance Type Indicator

SSBT: For this qualifier the use of Data Source Scheme "RT" (:4!c/RT/4!c) is compulsory.

For the code EARn the rule "1<=n<=9", e.g. EAR1, EAR2, ..., EAR9 applies.

Mandatory Repetitive Subsequence E1 Settlement Parties

— :95P: - Place of Settlement

PSET: For identification the BIC of the counterparty's CSD (depository) is used as the sole reference.

— :95P: - Receiving Agent

This field is used to identify the counterparty using the BIC.

— :97A: - Safekeeping Account

This field is optional. It is not considered for intra-CSD and cross-CSD settlement.

For transaction type external-CSD settlement this field must contain the securities account number as at present.

— :95a: - Receiver's Intermediary 2/Receiver's Intermediary 1/Receiving Custodian/ Buyer

It is possible to send all 5 parties (incl. DEAG). Please note, however, that except in the case of REAG the following sequence must be observed for the parties: DEI2, DEI1, DECU, SELL.

It is possible to shorten the chain, e.g. only SELL or only DEI1, DECU, SELL but the sequence must be observed in all cases.

— :95a: - Deliverer's Intermediary 2/Deliverer's Intermediary 1/Deliverer's Custodian/ Seller

Aside from the optional REAG, 4 additional parties can be specified on the deliverer side. For these 4 additional parties the following sequence must be observed: REI2, REI1, RECU, BUYR.

It is possible to shorten the chain, e.g. only BUYR or only REI1, RECU, BUYR but the sequence must be observed in all cases.

Mandatory Repetitive Subsequence E3 Amount

— :19A: - Settlement Amount

The cash amount can be specified in Euro or in foreign currency.

RWP – Receive with Payment: A negative sign [N] must be used. The amount will be credited on the account, although normally MT541 (RVP) would debit the amount from the account.

PFRD: In case of a payment without receipt (Sequence C :36B::SETT = 0) this field has to be provided unsigned.

PFRC: In case of a credit without receipt (Sequence C :36B::SETT = 0) this field has to be provided with a negative sign.

1.4.1.6.3 MT541 Examples

Transaction Type Cross-CSD Settlement

A OeKB CSD customer and a Clearstream Banking Frankfurt customer trade an AT ISIN versus payment. Both central securities depositories are counterparties within T2S.

— The RVP was submitted by the OeKB CSD customer with safekeeping account number OCSD224200.

— The counterparty is the Clearstream Banking Frankfurt customer with BIC DEUTDEFFXXX. In this transaction Deutsche Bank acts on behalf of its customer, Schnigge Wertpapierhandelsbank.

:16R:GENL

:20C::SEME//00004

:23G:NEWM

:16S:GENL

:16R:TRADDET

:98A::TRAD//20131025

:98A::SETT//20131030

:35B:ISIN AT000BSP0004

BEISPIEL 4 AG

:16S:TRADDET

:16R:FIAC

:36B::SETT//UNIT/3000,
:97A::SAFE//OCSD224200
:16S:FIAC
:16R:SETDET
:22F::SETR//TRAD
:16R:SETPRTY
:95P::PSET//DAKVDEFFXXX
:16S:SETPRTY
:16R:SETPRTY
:95P::DEAG//DEUTDEFFXXX
:16S:SETPRTY
:16R:SETPRTY
:95Q::SELL//Schnigge
:16S:SETPRTY
:16R:AMT
:19A::SETT//EUR26023,10
:16S:AMT
:16S:SETDET

Counterparty with Securities Account at CBF (DE-ISIN)

:16R:GENL
:20C::SEME//428132362
:23G:NEWM
:98C::PREP//20170221125403
:16S:GENL
:16R:TRADEDET
:98A::SETT//20170222
:98C::TRAD//20170220173300
:35B:ISIN DE000A1YCNN8
GxP German Properties AG o.N.(EUR)
:16S:TRADEDET
:16R:FIAC
:36B::SETT//UNIT/20000,
:97A::SAFE//OCSD220500
:97A::CASH//CATEURABCD BANKXXX
:16S:FIAC
:16R:SETDET
:22F::SETR//TRAD
:16R:SETPRTY
:95P::PSET//DAKVDEFFXXX
:16S:SETPRTY
:16R:SETPRTY
:95P::DEAG//CITIDEFFXXX

:16S:SETPRTY

:16R:SETPRTY

:95P::SELL//BLTRGB2LXXX

:97A::SAFE//21488201

:16S:SETPRTY

Transaction Type Intra-CSD Settlement with Partial Settlement

Two OeKB CSD customers trade an AT ISIN versus payment. Partial settlement is allowed.

- The RVP was submitted by the OeKB CSD customer with safekeeping account number OCSD224200.
- The counterparty is GUTBATWWXXX.

:16R:GENL

:20C::SEME//00003

:23G:NEWM

:16S:GENL

:16R:TRADDET

:98A::TRAD//20140630

:98A::SETT//20140701

:35B:ISIN AT0000720008

:16S:TRADDET

:16R:FIAC

:36B::SETT//UNIT/2000,

:97A::SAFE//OCSD227200

:16S:FIAC

:16R:SETDET

:22F::STCO//PART

:22F::SETR//TRAD

:16R:SETPRTY

:95P::PSET//OCSDATWWXXX

:16S:SETPRTY

:16R:SETPRTY

:95P::DEAG//GUTBATWWXXX

:16S:SETPRTY

:16R:AMT

:19A::SETT//EUR14410,

:16S:AMT

:16S:SETDET

Transaction Type PFRD

An OeKB CSD customer makes a payment to another OeKB CSD customer without receiving units. The instruction must contain an ISIN, the quantity is 0.

:16R:GENL

:20C::SEME//00004

:23G:NEWM
:16S:GENL
:16R:TRADEDET
:98A::TRAD//20140630
:98A::SETT//20140701
:35B:ISIN AT0000720008
:16S:TRADEDET
:16R:FIAC
:36B::SETT//UNIT/0,
:97A::SAFE//OCSD227600
:16S:FIAC
:16R:SETDET
:22F::SETR//TRAD
:16R:SETPRTY
:95P::PSET//OCSDATWWXXX
:16S:SETPRTY
:16R:SETPRTY
:95P::DEAG//GUTBATWWXXX
:16S:SETPRTY
:16R:AMT
:19A::SETT//EUR2530,
:16S:AMT
:16S:SETDET

Transaction Type RWP (Receive with Payment)

A OeKB CSD customer receives units and a cash amount. The sign for the amount must be changed.

:16R:GENL
:20C::SEME//00005
:23G:NEWM
:16S:GENL
:16R:TRADEDET
:98A::TRAD//20140630
:98A::SETT//20140701
:35B:ISIN ATOTEAKHOLZ8
:16S:TRADEDET
:16R:FIAC
:36B::SETT//UNIT/5000,
:97A::SAFE//OCSD225200
:16S:FIAC
:16R:SETDET
:22F::SETR//TRAD
:16R:SETPRTY
:95P::PSET//OCSDATWWXXX

:16S:SETPRTY
:16R:SETPRTY
:95P::DEAG//TUBDDEDDXXX
:16S:SETPRTY
:16R:AMT
:19A::SETT//NEUR4200,
:16S:AMT
:16S:SETDET

1.4.1.7 MT542 – Deliver Free of Payment

MT542 is used for the delivery of securities free of payment (DFP).

1.4.1.7.1 Content

M/O	Tag	Field Name	Qualifier	Option	Format	Codes	Description
Mandatory Sequence A General Information							
M	:16R:	Start of Block			16c	GENL	
M	:20C:	Sender's Reference	SEME		:4!c//16x		Reference assigned by the sender to unambiguously identify the message
M	:23G:	Function of the Message			4!c	PREA NEWM CANC	Message preadvising a settlement instruction. New message Message requesting the cancellation of a previously sent message.
O	:99B:	Number Count	SETT		:4!c//3!n	000-999	Sequential number of the instruction in a range of linked settlement instructions.
O	:99B:	Number Count	TOSE		:4!c//3!n	000-999	Total number of settlement instructions that are linked together.
Optional Repetitive Subsequence A1 Linkages							
M	:16R:	Start of Block			16c	LINK	
O	:22F:	Linkage Type Indicator	LINK		:4!c/[8c]/4!c	AFTE	Indicates that the message is to be processed after the linked message.

M/O	Tag	Field Name	Qualifier	Option	Format	Codes	Description
						BEFO	Indicates that the message is to be processed before the linked message.
						WITH	Indicates that the message is to be processed with the linked message.
						INFO	Indicates that the messages are linked for information purposes only.
O	:13A:	Linked Transaction	LINK		:4!c//3!c		Message type number/message identifier of the message referenced in the linkage sequence.
M	:20C:	Reference	RELA		:4!c//16x		Related Message Reference
			PREV				Previous Message Reference
			PREA				PreAdvice Message Reference
			POOL				Pool Reference
			COMM				Common Reference
			PCTI				Processor Transaction Identification
M	:16S:	End of Block			16c	LINK	
End of Subsequence A1 Linkages							
M	:16S:	End of Block			16c	GENL	
End of Sequence A General Information							
Mandatory Sequence B Trade Details							
M	:16R:	Start of Block			16c	TRADDET	
O	:94H:	Place of Clearing	CLEA		:4!c//4!a2!a2!c[3!c]		
O	:94B:	Place of Trade	TRAD		:4!c//4!c[/30x]	EXCH	Place of trade is a stock exchange
						OTCO	Place of trade is over the counter.
						PRIM	Place of trade is the primary market.
						SECM	Place of trade is the secondary market.
						VARI	Trade was executed on various places.
M	:98a:	Trade Date/Time	TRAD	A	:4!c//8!n		Date at which the trade was executed.

M/O	Tag	Field Name	Qualifier	Option	Format	Codes	Description
				C	:4!c//8!n6!n		Date and time at which the trade was executed.
M	:98A:	Settlement Date	SETT		:4!c//8!n		Date at which the financial instruments are to be delivered or received.
M	:35B:	Identification of the Financial Instrument			ISIN!e12!c 4*35x		"ISIN" followed by <Blank> and ISIN Code Description of the financial instrument (optional)
O	:22F:	Priority Indicator	PRIR		:4!c//4!c	0003 0004	High priority Normal priority
O	:22F:	Trade Transaction Condition Indicator	TTCO		:4!c/[8c]/4!c	CCPN XCPN	Trade was executed cum coupon. Trade was executed ex coupon.
O	:25D:	Status	MTCH		:4!c/[8c]/4!c	MACH	Instruction has been matched.
O	:70E:	Narrative	SPRO		:4!c//10*35x		Provides additional settlement processing information which cannot be included within the structured fields of the message.
M	:16S:	End of Block			16c	TRADEDET	
End of Sequence B Trade Details							
Mandatory Sequence C Financial Instrument/Account							
M	:16R:	Start of Block			16c	FIAC	
M	:36B:	Quantity of Financial Instrument to be Settled	SETT		:4!c//4!c/15d	FAMT UNIT	Face amount Unit number
M	:97A:	Safekeeping Account	SAFE		:4!c//35x		OeKB CSD's securities account number of the customer
Optional Repetitive Subsequence C1 Quantity Breakdown							
M	:16R:	Start of Block			16c	BREAK	
M	:13B:	Lot Number	LOTS		:4!c/[8c]/30x		Number identifying a lot constituting the financial instrument.
M	:16S:	End of Block				BREAK	
End of Subsequence C1 Quantity Breakdown							
M	:16S:	End of Block			16c	FIAC	
End of Sequence C Financial Instrument/Account							
Mandatory Sequence E Settlement Details							

M/O	Tag	Field Name	Qualifier	Option	Format	Codes	Description
M	:16R:	Start of Block			16c	SETDET	
M	:22F:	Type of Settlement Transaction	SETR		:4!c/[8!c]/4!c	TRAD	Specifies underlying information regarding the type of settlement transaction
					:4!c/COEX/4!c	AUTO	Auto-collateralisation, in case of an Intra-day Restriction on the eligible ISIN
O	:22F:	Settlement Transaction Condition Indicator	STCO		:4!c/[8c]/4!c	NPAR	Partial settlement is not allowed.
						PART	Partial settlement is allowed.
						NOMC	No market claim should be automatically generated.
					:4!c/COEX/4!c	PARQ	Partial Settlement is Allowed with Minimum Quantity
						PARC	Partial Settlement is Allowed with Minimum Cash Value
					:4!c/REGL/4!c	BSSP	Instruction Resulting from Partially Successful Buy-In
O	:22F:	Securities Sub-balance Type Indicator	SSBT		:4!c/[8c]/4!c	BLO n	Blocking
						RES n	Reservation
						EEUR	Earmarking for autocoll.
						EAR n	Other earmarking
O	:22F:	Beneficial Ownership Indicator	BENE		:4!c/[8c]/4!c	NBEN	No Change of Beneficial Ownership (NCBO)
						YBEN	Change of Beneficial Ownership (CBO)
Mandatory Repetitive Subsequence E1 Settlement Parties							
M	:16R:	Start of Block			16c	SETPRTY	
M	:95P:	Place of Settlement	PSET		:4!c//4!a2!a2!c[3!c]		Place of settlement (depository)
M	:16S:	End of Block			16c	SETPRTY	
M	:16R:	Start of Block			16c	SETPRTY	
M	:95P:	Receiving Agent	REAG		:4!c//4!a2!a2!c[3!c]		Receiving party that interacts with the place of settlement

M/O	Tag	Field Name	Qualifier	Option	Format	Codes	Description
(M)	:97A:	Safekeeping Account	SAFE		:4!c//35x		Counterparty's securities acc. number
M	:16S:	End of Block			16c	SETPRTY	
O	:16R:	Start of Block			16c	SETPRTY	
O	:95a:	Receiver's Intermediary 2	REI2	P R Q	:4!c//4!a2!a2!c[3!c] :4!c/8!c/34x :4!c//4*35x		Party that interacts with the receiver's intermediary 1
O	:97A:	Safekeeping Account	SAFE		:4!c//35x		No. of securities acc. held with the party one step higher in the chain
O	:16S:	End of Block			16c	SETPRTY	
O	:16R:	Start of Block			16c	SETPRTY	
O	:95a:	Receiver's Intermediary 1	REI1	P R Q	:4!c//4!a2!a2!c[3!c] :4!c/8!c/34x :4!c//4*35x		Party that interacts with the receiving agent
O	:97A:	Safekeeping Account	SAFE		:4!c//35x		No. of securities acc. held with the party one step higher in the chain
O	:16S:	End of Block			16c	SETPRTY	
O	:16R:	Start of Block			16c	SETPRTY	
O	:95a:	Receiver's Custodian	RECU	P R Q	:4!c//4!a2!a2!c[3!c] :4!c/8!c/34x :4!c//4*35x		Party that interacts with the receiving agent unless intermediaries exist
O	:97A:	Safekeeping Account	SAFE		:4!c//35x		No. of securities acc. held with the party one step higher in the chain
O	:16S:	End of Block			16c	SETPRTY	
O	:16R:	Start of Block			16c	SETPRTY	
O	:95a:	Buyer	BUYR	P R Q	:4!c//4!a2!a2!c[3!c] :4!c/8!c/34x :4!c//4*35x		Party that receives the financial instrument
O	:97A:	Safekeeping Account	SAFE		:4!c//35x		No. of securities acc. held with the party one step higher in the chain
O	:16S:	End of Block			16c	SETPRTY	
O	:16R:	Start of Block			16c	SETPRTY	

M/O	Tag	Field Name	Qualifier	Option	Format	Codes	Description
O	:95P:	Delivering Agent	DEAG		:4!c//4!a2!a2!c[3!c]	SETPRTY	Delivering party that interacts with the place of settlement.
O	:16S:	End of Block			16c	SETPRTY	
O	:16R:	Start of Block			16c	SETPRTY	
O	:95a:	Deliverer's Intermediary 2	DEI2	P R Q	:4!c//4!a2!a2!c[3!c] :4!c/8!c/34x :4!c//4*35x		Party that interacts with the deliverer's intermediary 1
O	:97A:	Safekeeping Account	SAFE		:4!c//35x		No. of securities acc. held with the party one step higher in the chain
O	:16S:	End of Block			16c	SETPRTY	
O	:16R:	Start of Block			16c	SETPRTY	
O	:95a:	Deliverer's Intermediary 1	DEI1	P R Q	:4!c//4!a2!a2!c[3!c] :4!c/8!c/34x :4!c//4*35x		Party that interacts with the delivering agent
O	:97A:	Safekeeping Account	SAFE		:4!c//35x		No. of securities acc. held with the party one step higher in the chain
O	:16S:	End of Block			16c	SETPRTY	
O	:16R:	Start of Block			16c	SETPRTY	
O	:95a:	Deliverer's Custodian	DECU	P R Q	:4!c//4!a2!a2!c[3!c] :4!c/8!c/34x :4!c//4*35x		Party that interacts with the delivering agent unless intermediaries exist
O	:97A:	Safekeeping Account	SAFE		:4!c//35x		No. of securities acc. held with the party one step higher in the chain
O	:16S:	End of Block			16c	SETPRTY	
O	:16R:	Start of Block			16c	SETPRTY	
O	:95a:	Seller	SELL	P R Q	:4!c//4!a2!a2!c[3!c] :4!c/8!c/34x :4!c//4*35x		Party that delivers the financial instrument
O	:97A:	Safekeeping Account	SAFE		:4!c//35x		No. of securities acc. held with the party one step higher in the chain
M	:16S:	End of Block			16c	SETPRTY	
End of Subsequence E1 Settlement Parties							
M	:16S:	End of Block			16c	SETDET	
End of Sequence E Settlement Detail							

1.4.1.7.2 Explanation of the SWIFT Fields

Sequence A – General Information

— :23G: - Function of the Message

The PREA/NEWM function will be replaced with Hold/Release in T2S. The PREA/NEWM function will remain available for submitting instructions in ISO 15022 format.

PREA: New instruction with On Hold = yes; The position is not released for settlement.

NEWM: New instruction with On Hold = no; The position is released for settlement. After a NEWM was submitted an MT530 or the Settlement Client must be used to change the On Hold setting.

CANC: Cancellation of the instruction.

— :99B: - Number Count

Instructions with a pool reference must include a pool counter indicating the total number of linked instructions.

SETT: Mandatory if the pool reference in the Optional Repetitive Subsequence A1 Linkages is filled.

TOSE: Mandatory if the pool reference in the Optional Repetitive Subsequence A1 Linkages is filled.

External-CSD Settlement: Linking of instructions is not possible.

— :22F: - Linkage Type Indicator

AFTE: Current instruction will be settled AFTER the linked-to instruction.

BEFO: Current instruction will be settled BEFORE the linked-to instruction.

WITH: Current instruction will be settled together WITH the linked-to instruction.

INFO: The LINK is added for informational purposes only and has no effects on the processing.

External-CSD Settlement: Linking of instructions is not possible.

Optional Repetitive Subsequence A1 Linkages

— :20C: - Reference

RELA: Customer reference of the referenced instruction (if A1:22F:LINK exists in this subsequence).

PREV: Customer reference of the instruction to be cancelled (in case of A:23G:CANC).

PREA: Customer reference of the instruction with PREA function (in case of A:23G:NEWM).

POOL: A pool reference can be used to link more than two instructions. It is a collective reference for a set of settlement instructions which must be settled collectively "all-or-none".

COMM: Unique reference agreed between two counterparties to identify the instruction (optional matching field).

PCTI: In case of cancellation orders for instructions where the instructing party is different from the instructing party of the instruction being cancelled, this field has to contain the PCTI reference from the MT 548 status message.

- Instructions, which have been created by the OeKB CSD as instructing party (e.g. market claim or transformation)
- Instructions, which have been created by an authorised party but which are cancelled by the securities account owner

In addition the field :20C::PREV must be filled in with NONREF, because according to ISO 15022 SWIFT standard field :20C::PREV must be present, if field :23G: is CANC.

Mandatory Sequence B Trade Details

— :98A: - Date/Time

SETT: It is no longer possible to specify the exact time on the settlement day.

— :22F: - Priority Indicator

PRIR: When prioritising instructions it is possible to choose from 2 priority levels: High Priority (0003) and Normal Priority (0004). For details, please see *Annex B Guideline Settlement and Securities Account Administration*.

External-CSD Settlement: Prioritising of instructions is not possible.

— :22F: - Trade Transaction Condition Indicator

TTCO: This qualifier specifies whether the security is delivered with (CCPN – Cum Coupon) or without (XCPN – Ex Coupon) coupon (additional matching field).

External-CSD Settlement: This indicator is not used.

Mandatory Sequence C Financial Instrument/Account

— :97A: Safekeeping Account

The securities account number can be specified in the old format (e.g. 123400) or in the new format "OCSD + existing securities account number" (e.g. OCSD123400).

Optional Repetitive Subsequence C1 Quantity Breakdown

— :13B: - Lot Number

LOTS: To use a blocked/reserved position for an instruction this field must contain the restriction reference number.

External-CSD Settlement: This subsequence is not used.

Mandatory Sequence E Settlement Details

— :22F: -Settlement Transaction Condition Indicator

NPAR: Partial settlement of an instruction is not allowed.

PART: Partial settlement of an instruction is allowed.

PARQ: Partial Settlement is allowed with Minimum Quantity

PARC: Partial Settlement is allowed with Minimum Cash Value

NOMC: Opt-out indicator (additional matching field).

BSSP: Instruction Resulting from Partially Successful Buy-In. If the matching instruction is also instructed with this Settlement Transaction Condition both instructions will be exempt from Late Matching penalty fees. It is not a matching field.

For details, please see *Annex 8 Guideline Settlement and Securities Account Administration*.

External-CSD Settlement: Partial settlement is not possible.

— :22F: - Securities Sub-balance Type Indicator

SSBT: For this qualifier the use of Data Source Scheme "RT" (:4!c/RT/4!c) is compulsory.

For codes BLOn, RESn and EARn the rule "1<=n<=9", e.g. BLO1, BLO2,...., BLO9 applies. If SSBT is used a position with the corresponding restriction type (e.g. BLO1) must e.

Mandatory Repetitive Subsequence E1 Settlement Parties

— :95P: - Place of Settlement

PSET: For identification the BIC of the counterparty (depository) is used as the sole reference.

Exception: Transaction type external-CSD settlement – in this case the place of settlement must be specified as at present.

— :95P: - Receiving Agent

This field is used to identify the counterparty using the BIC.

— :97A: - Safekeeping Account

For transaction type external-CSD settlement this field must contain the securities account number as at present.

— :95a: - Receiver's Intermediary 2/Receiver's Intermediary 1/Receiving Custodian/ Buyer

It is possible to send all 5 parties (incl. REAG). Please note, however, that except in the case of REAG the following sequence must be observed for the parties: REI2, REI1, RECU, BUYR.

It is possible to shorten the chain, e.g. only BUYR or only REI1, RECU, BUYR but the sequence must be observed in all cases.

— :95a: - Deliverer's Intermediary 2/Deliverer's Intermediary 1/Deliverer's Custodian/ Seller

Aside from the optional DEAG, 4 additional parties can be specified on the deliverer side. For these 4 additional parties the following sequence must be observed: DEI2, DEI1, DECU, SELL.

It is possible to shorten the chain, e.g. only SELL or only DE11, DECU, SELL but the sequence must be observed in all cases.

1.4.1.7.3 MT542 Examples

Transaction Type Intra-CSD without Partial Settlement

Free of payment delivery of units from OeKB CSD customer OCSD227600 to a OeKB CSD customer. Partial settlement is not allowed.

:16R:GENL
:20C::SEME//00011
:23G:NEWM
:16S:GENL
:16R:TRADEDET
:98A::TRAD//20140630
:98A::SETT//20140701
:35B:ISIN AT0000720008
:16S:TRADEDET
:16R:FIAC
:36B::SETT//UNIT/1000,
:97A::SAFE//OCSD227600
:16S:FIAC
:16R:SETDET
:22F::STCO//NPAR
:22F::SETR//TRAD
:16R:SETPRTY
:95P::PSET//OCSDATWWXXX
:16S:SETPRTY
:16R:SETPRTY
:95P::REAG//DEUTDEFFXXX
:16S:SETPRTY
:16R:SETPRTY
:95P::BUYR//MGTCBEBEXXX
:16S:SETPRTY
:16S:SETDET

Transaction Type Cross-CSD Settlement

Free of payment delivery from OeKB CSD customer OCSD227600 to a customer of Clearstream Banking Frankfurt.

:16R:GENL
:20C::SEME//00022
:23G:NEWM
:16S:GENL

:16R:TRADEDET
:98A::TRAD//20140630
:98A::SETT//20140701
:35B:ISIN DE0007100000
:16S:TRADEDET
:16R:FIAC
:36B::SETT//FAMT/10000,
:97A::SAFE//OCSD227600
:16S:FIAC
:16R:SETDET
:22F::SETR//TRAD
:16R:SETPRTY
:95P::PSET//DAKVDEFFXXX
:16S:SETPRTY
:16R:SETPRTY
:95P::REAG//DEUTDEFFXXX
:16S:SETPRTY
:16R:SETPRTY
:95Q::BUYR//Deutsche Bank Muenchen
:16S:SETPRTY
:16S:SETDET

Counterparty with Securities Account at CBF (AT-ISIN)

:16R:GENL
:20C::SEME//G2215721342512
:23G:NEWM
:16S:GENL
:16R:TRADEDET
:98A::SETT//20170210
:98A::TRAD//20170209
:35B:ISIN AT0000720008
TELEKOM AUSTRIA AKT O N
:16S:TRADEDET
:16R:FIAC
:36B::SETT//UNIT/100,
:97A::SAFE//OCSD227300
:16S:FIAC
:16R:SETDET
:22F::SETR//TRAD
:16R:SETPRTY
:95P::REAG//BIWBDE33XXX
:16S:SETPRTY
:16R:SETPRTY

:95Q::BUYR//Hans Mustermann
:97A::SAFE//52110693578
:16S:SETPRTY
:16R:SETPRTY
:95P::PSET//DAKVDEFFXXX
:16S:SETPRTY
:16S:SETDET

Counterparty with Securities Account at Euroclear France (FR-ISIN)

:16R:GENL
:20C::SEME//5303637
:23G:NEWM
:98C::PREP//20170215081317
:16S:GENL
:16R:TRADDET
:98A::TRAD//20170206
:98A::SETT//20170207
:35B:ISIN FR0011472943
VALNEVA SE PREF. EO -,01
:16S:TRADDET
:16R:FIAC
:36B::SETT//UNIT/2000,
:97A::SAFE//OCSD227200
:16S:FIAC
:16R:SETDET
:22F::SETR//TRAD
:16R:SETPRTY
:95P::BUYR//KBSEBE22XXX
:16S:SETPRTY
:16R:SETPRTY
:95P::PSET//SICVFRPPXXX
:16S:SETPRTY
:16R:SETPRTY
:95P::REAG//CITTGB21003
:16S:SETPRTY
:16S:SETDET

Counterparty with Securities Account at Euroclear Nederland (NL-ISIN)

:16R:GENL
:20C::SEME//201700581235
:23G:NEWM

:16S:GENL
:16R:TRADEDET
:98A::SETT//20170208
:98A::TRAD//20170206
:35B:ISIN NL0010200606
NIEDERLANDE
EO-ANL. 2012(18)
:16R:FIA
:11A::DENO//EUR
:16S:FIA
:16S:TRADEDET
:16R:FIAC
:36B::SETT//FAMT/10000000,
:97A::SAFE//OCSD229500
:16S:FIAC
:16R:SETDET
:22F::SETR//TRAD
:16R:SETPRTY
:95P::PSET//NECINL2AXXX
:16S:SETPRTY
:16R:SETPRTY
:95P::BUYR//RZBAATWWXXX
:16S:SETPRTY
:16R:SETPRTY
:95P::REAG//CEDELULLXXX
:16S:SETPRTY
:16R:SETPRTY

Counterparty with Securities Account at Monte Titoli (IT-ISIN)

:16R:GENL
:20C::SEME//123456720170215
:23G:NEWM
:98C::PREP//20170210100955
:16S:GENL
:16R:TRADEDET
:98A::TRAD//20170209
:98A::SETT//20170209
:35B:ISIN IT0001444378
6PZT B.T.P. 2031
:16S:TRADEDET
:16R:FIAC
:36B::SETT//FAMT/10000000,
:97A::SAFE//OCSD236500

:16S:FIAC
:16R:SETDET
:22F::SETR//TRAD
:16R:SETPRTY
:95P::BUYR//RZOOAT2LXXX
:16S:SETPRTY
:16R:SETPRTY
:95P::REAG//MGTCBEBEECL
:16S:SETPRTY
:16R:SETPRTY
:95P::PSET//MOTIITMMXXX
:16S:SETPRTY
:16S:SETDET

Counterparty with Securities Account at SIX SIS (AT-ISIN), SIX SIS instructs via T2S in its role as CSD

(In many cases SIX SIS instructs in its role as participant at OeKB CSD with T2S party BIC INSECHZZTRA.)

:16R:GENL
:20C::SEME//2993745307218B
:23G:NEWM
:16S:GENL
:16R:TRADEDET
:98A::SETT//20170217
:98A::TRAD//20170216
:35B:ISIN AT0000922554
ROSENBAUER INTERNAT AKT.
:22F::PRIR//0004
:16S:TRADEDET
:16R:FIAC
:36B::SETT//UNIT/75,
:97A::SAFE//OCSD244000
:16S:FIAC
:16R:SETDET
:22F::SETR//TRAD
:22F::STCO//NOMC
:16R:SETPRTY
:95P::SELL//ABNCNL2AXXX
:97A::SAFE//NL100263
:16S:SETPRTY
:16R:SETPRTY
:95P::DEAG//INSECHZZTRA
:16S:SETPRTY
:16R:SETPRTY

:95P::REAG//ABNCNL2AXXX
:16S:SETPRTY
:16R:SETPRTY
:95P::PSET//INSECHZZXXX
:16S:SETPRTY
:16S:SETDET

Counterparty with Securities Account at SIX SIS (AT-ISIN), SIX SIS instructs in its role as participant at OeKB CSD

:16R:GENL
:20C::SEME//124794
:23G:PREA
:16S:GENL
:16R:TRADDET
:98A::SETT//20170926
:98A::TRAD//20170926
:35B:ISIN AT0000A15HF7
DO + CO Anleihe 14-21
:22F::PRIR//0004
:16S:TRADDET
:16R:FIAC
:36B::SETT//FAMT/5000,
:97A::SAFE//222100
:16S:FIAC
:16R:SETDET
:22F::SETR//TRAD
:16R:SETPRTY
:95P::DEAG//BKAUATWWXXX
:16S:SETPRTY
:16R:SETPRTY
:95P::REAG//INSECHZZTRA
:16S:SETPRTY
:16R:SETPRTY
:95P::BUYR//UBSWCHZH80A
:97A::SAFE//CH100025
:16S:SETPRTY
:16R:SETPRTY
:95P::PSET//OCSDATWWXXX
:16S:SETPRTY
:16S:SETDET

Transaction Type External

Counterparty with Securities Account at CBL (Standard External)

:16R:GENL
:20C::SEME//79112320170220
:23G:NEWM
:98C::PREP//20170220085355
:16S:GENL
:16R:TRADEDET
:98A::TRAD//20170206
:98A::SETT//20170207
:35B:ISIN XS1294342792
OMV HYBRIDANL. 15-UND.
:16S:TRADEDET
:16R:FIAC
:36B::SETT//FAMT/10000,
:97A::SAFE//OCSD227200
:16S:FIAC
:16R:SETDET
:22F::SETR//TRAD
:16R:SETPRTY
:95P::REAG//RZBAATWWXXX
:97A::SAFE//12467
:16S:SETPRTY
:16R:SETPRTY
:95P::PSET//CEDELULLXXX
:16S:SETPRTY
:16S:SETDET

Counterparty with Securities Account at Euroclear Bank (Bridge)

:16R:GENL
:20C::SEME//19398627
:23G:NEWM
:16S:GENL
:16R:TRADEDET
:98A::SETT//20170120
:98A::TRAD//20170120
:35B:ISIN XS0690623771
4,25P EVN AG MTN.11
13.4. 22
:16S:TRADEDET
:16R:FIAC
:36B::SETT//FAMT/1000,
:97A::SAFE//OCSD248300
:16S:FIAC
:16R:SETDET

:22F::SETR//TRAD
:22F::RTGS//NRTG
:16R:SETPRTY
:95P::PSET//MGTCBEBEXXX
:16S:SETPRTY
:16R:SETPRTY
:95P::REAG//DEUTDEFFXXX
:97A::SAFE//91479
:16S:SETPRTY
:16R:SETPRTY
:95P::BUYR//DEUTDEFFXXX
:16S:SETPRTY
:16S:SETDET

1.4.1.8 MT543 – Delivery Against Payment

MT543 is used for delivery instructions versus payment (DVP), for delivery with payment (DWP) and for payments free of delivery (PFDD) and credits free of delivery (PFDC). MT543 cannot be used for External instructions.

Multicurrency settlement instructions: DWP and PFDD and PFDC are not used

1.4.1.8.1 Content

M/O	Tag	Field Name	Qualifier	Option	Format	Codes	Description
Mandatory Sequence A General Information							
M	:16R:	Start of Block			16c	GENL	
M	:20C:	Sender's Reference	SEME		:4!c//16x		Reference assigned by the sender to unambiguously identify the message
M	:23G:	Function of the Message			4!c	PREA	Message preadvising a settlement instruction.
						NEWM	New message
						CANC	Message requesting the cancellation of a previously sent message.
O	:99B:	Number Count	SETT		:4!c//3!n	000-999	Sequential number of the instruction in a range of linked settlement instructions.

M/O	Tag	Field Name	Qualifier	Option	Format	Codes	Description
O	:99B:	Number Count	TOSE		:4!c//3!n	000-999	Total number of settlement instructions that are linked together.
Optional Repetitive Subsequence A1 Linkages							
M	:16R:	Start of Block			16c	LINK	
O	:22F:	Linkage Type Indicator	LINK		:4!c/[8c]/4!c	AFTE	Indicates that the message is to be processed after the linked message.
						BEFO	Indicates that the message is to be processed before the linked message.
						WITH	Indicates that the message is to be processed with the linked message.
						INFO	Indicates that the messages are linked for information purposes only.
O	:13A:	Linked Transaction	LINK		:4!c//3!c		Message type number/message identifier of the message referenced in the linkage sequence.
M	:20C:	Reference	RELA		:4!c//16x		Related Message Reference
			PREV			Previous Message Reference	
			PREA			Preadvice Message Reference	
			POOL			Pool Reference	
			COMM			Common Reference	
			PCTI			Processor Transaction Identification	
M	:16S:	End of Block			16c	LINK	
End of Subsequence A1 Linkages							
M	:16S:	End of Block			16c	GENL	

M/O	Tag	Field Name	Qualifier	Option	Format	Codes	Description
End of Sequence A General Information							
Mandatory Sequence B Trade Details							
M	:16R:	Start of Block			16c	TRADDET	
O	:94H:	Place of Clearing	CLEA		:4!c//4!a2!a2!c[3!c]		
O	:94B:	Place of Trade	TRAD		:4!c//4!c[/30x]	EXCH	Place of trade is a stock exchange
						OTCO	Place of trade is over the counter.
						PRIM	Place of trade is the primary market.
						SECM	Place of trade is the secondary market.
						VARI	Trade was executed on various places.
M	:98a:	Trade Date/Time	TRAD	A	:4!c//8!n		Date at which the trade was executed.
				C	:4!c//8!n6!n		Date and time at which the trade was executed.
M	:98A:	Settlement Date	SETT		:4!c//8!n		Date at which the financial instruments are to be delivered or received.
M	:35B:	Identification of the Financial Instrument			ISIN1!e12!c 4*35x		"ISIN" followed by <Blank> and ISIN Code Description of the financial instrument (optional)
O	:22F:	Priority Indicator	PRIR		:4!c//4!c	0003	High priority
						0004	Normal priority
O	:22F:	Trade Transaction Condition Indicator	TTCO		:4!c/[8c]/4!c	CCPN	Trade was executed cum coupon.
						XCPN	Trade was executed ex coupon.
O	:25D:	Status	MTCH		:4!c/[8c]/4!c	MACH	Instruction has been matched.

M/O	Tag	Field Name	Qualifier	Option	Format	Codes	Description
O	:70E:	Narrative	SPRO		:4!c//10*35x		Provides additional settlement processing information which cannot be included within the structured fields of the message.
M	:16S:	End of Block			16c	TRADEDET	
End of Sequence B Trade Details							
Mandatory Sequence C Financial Instrument/Account							
M	:16R:	Start of Block			16c	FIAC	
M	:36B:	Quantity of Financial Instrument to be Settled	SETT		:4!c//4!c/15d	FAMT UNIT	Face amount Unit number
M	:97A:	Safekeeping Account	SAFE		:4!c//35x		OeKB CSD's securities account number of the customer
O	:97A:	Cash Account	CASH		:4!c//35x		Account in which cash is maintained
Optional Repetitive Subsequence C1 Quantity Breakdown							
M	:16R:	Start of Block			16c	BREAK	
M	:13B:	Lot Number	LOTS		:4!c/[8c]/30x		Number identifying a lot constituting the financial instrument.
M	:16S:	End of Block				BREAK	
End of Subsequence C1 Quantity Breakdown							
M	:16S:	End of Block			16c	FIAC	
End of Sequence C Financial Instrument/Account							
Mandatory Sequence E Settlement Details							
M	:16R:	Start of Block			16c	SETDET	
M	:22F:	Type of Settlement Transaction	SETR		:4!c/[8!c]/4!c	TRAD	Specifies underlying information regarding the type of settlement transaction
					:4!c/COEX/4!c	AUTO	Auto-collateralisation, in case of an Intra-day Restriction on the eligible ISIN

M/O	Tag	Field Name	Qualifier	Option	Format	Codes	Description
O	:22F:	Settlement Transaction Condition Indicator	STCO		:4!c/[8c]/4!c	NPAR	Partial settlement is not allowed.
						PART	Partial settlement is allowed.
						NOMC	No market claim should be automatically generated.
						PARQ	Partial Settlement is Allowed with Minimum Quantity
						PARC	Partial Settlement is Allowed with Minimum Cash Value
					:4!c/COEX/4!c	BSSP	Instruction Resulting from Partially Successful Buy-In
O	:22F:	Securities Sub-balance Type Indicator	SSBT		:4!c/[8c]/4!c	BLO <i>n</i>	Blocking
						RES <i>n</i>	Reservation
						EEUR	Earmarking for autocoll.
						EAR <i>n</i>	Other earmarking
O	:22F:	Beneficial Ownership Indicator	BENE		:4!c/[8c]/4!c	NBEN	No Change of Beneficial Ownership (NCBO)
						YBEN	Change of Beneficial Ownership (CBO)

Mandatory Repetitive Subsequence E1 Settlement Parties

M	:16R:	Start of Block			16c	SETPRTY	
M	:95P:	Place of Settlement	PSET		:4!c//4!a2!a2!c[3!c]		Place of settlement (depository)
M	:16S:	End of Block			16c	SETPRTY	
M	:16R:	Start of Block			16c	SETPRTY	
M	:95P:	Receiving Agent	REAG		:4!c//4!a2!a2!c[3!c]		Receiving party that interacts with the place of settlement
(M)	:97A:	Safekeeping Account	SAFE		4!c//35x		Counterparty's securities acc. number

M/O	Tag	Field Name	Qualifier	Option	Format	Codes	Description
M	:16S:	End of Block			16c	SETPRTY	
O	:16R:	Start of Block			16c	SETPRTY	
O	:95a:	Receiver's Intermediary 2	REI2	P	:4!c//4!a2!a2!c[3!c]		Party that interacts with the receiver's intermediary 1
				R	:4!c/8!c/34x		
				Q	:4!c//4*35x		
O	:97A:	Safekeeping Account	SAFE		:4!c//35x		No. of securities acc. held with the party one step higher in the chain
O	:16S:	End of Block			16c	SETPRTY	
O	:16R:	Start of Block			16c	SETPRTY	
O	:95a:	Receiver's Intermediary 1	REI1	P	:4!c//4!a2!a2!c[3!c]		Party that interacts with the receiving agent
				R	:4!c/8!c/34x		
				Q	:4!c//4*35x		
O	:97A:	Safekeeping Account	SAFE		:4!c//35x		No. of securities acc. held with the party one step higher in the chain
O	:16S:	End of Block			16c	SETPRTY	
O	:16R:	Start of Block			16c	SETPRTY	
O	:95a:	Receiver's Custodian	RECU	P	:4!c//4!a2!a2!c[3!c]		Party that interacts with the receiving agent unless intermediaries exist
				R	:4!c/8!c/34x		
				Q	:4!c//4*35x		
O	:97A:	Safekeeping Account	SAFE		:4!c//35x		No. of securities acc. held with the party one step higher in the chain
O	:16S:	End of Block			16c	SETPRTY	
O	:16R:	Start of Block			16c	SETPRTY	
O	:95a:	Buyer	BUYR	P	:4!c//4!a2!a2!c[3!c]		Party that receives the financial instrument
				R	:4!c/8!c/34x		
				Q	:4!c//4*35x		

M/O	Tag	Field Name	Qualifier	Option	Format	Codes	Description
O	:97A:	Safekeeping Account	SAFE		:4!c//35x		No. of securities acc. held with the party one step higher in the chain
O	:16S:	End of Block			16c	SETPRTY	
O	:16R:	Start of Block			16c	SETPRTY	
O	:95P:	Delivering Agent	DEAG		:4!c//4!a2!a2!c[3!c]	SETPRTY	Delivering party that interacts with the place of settlement.
O	:16S:	End of Block			16c	SETPRTY	
O	:16R:	Start of Block			16c	SETPRTY	
O	:95a:	Deliverer's Intermediary 2	DEI2	P	:4!c//4!a2!a2!c[3!c]		Party that interacts with the deliverer's intermediary 1
				R	:4!c/8!c/34x		
				Q	:4!c//4*35x		
O	:97A:	Safekeeping Account	SAFE		:4!c//35x		No. of securities acc. held with the party one step higher in the chain
O	:16S:	End of Block			16c	SETPRTY	
O	:16R:	Start of Block			16c	SETPRTY	
O	:95a:	Deliverer's Intermediary 1	DEI1	P	:4!c//4!a2!a2!c[3!c]		Party that interacts with the delivering agent
				R	:4!c/8!c/34x		
				Q	:4!c//4*35x		
O	:97A:	Safekeeping Account	SAFE		:4!c//35x		No. of securities acc. held with the party one step higher in the chain
O	:16S:	End of Block			16c	SETPRTY	
O	:16R:	Start of Block			16c	SETPRTY	
O	:95a:	Deliverer's Custodian	DECU	P	:4!c//4!a2!a2!c[3!c]		Party that interacts with the delivering agent unless intermediaries exist
				R	:4!c/8!c/34x		
				Q	:4!c//4*35x		

M/O	Tag	Field Name	Qualifier	Option	Format	Codes	Description
O	:97A:	Safekeeping Account	SAFE		:4!c//35x		No. of securities acc. held with the party one step higher in the chain
O	:16S:	End of Block			16c	SETPRTY	
O	:16R:	Start of Block			16c	SETPRTY	
O	:95a:	Seller	SELL	P	:4!c//4!a2!a2!c[3!c]		Party that delivers the financial instrument
				R	:4!c/8!c/34x		
				Q	:4!c//4*35x		
O	:97A:	Safekeeping Account	SAFE		:4!c//35x		No. of securities acc. held with the party one step higher in the chain
M	:16S:	End of Block			16c	SETPRTY	
End of Subsequence E1 Settlement Parties							
Mandatory Repetitive Subsequence E3 Amount							
M	:16R:	Start of Block			16c	AMT	
M	:19A:	Settlement Amount	SETT		:4!c//[N]3!a15d		ISO-Currency code followed by cash amount
M	:16S:	End of Block			16c	AMT	
End of Subsequence E3 Amount							
End of Sequence E Settlement Details							

1.4.1.8.2 Explanation of the SWIFT Fields

Sequence A – General Information

— :23G: - Function of the Message

The PREA/NEWM function will be replaced with Hold/Release in T2S. The PREA/NEWM function will remain available for submitting instructions in ISO 15022 format.

PREA: New instruction with On Hold = yes; The position is not released for settlement.

NEWM: New instruction with On Hold = no; The position is released for settlement. After a NEWM was submitted an MT530 or the Settlement Client must be used to change the On Hold setting.

CANC: Cancellation of the instruction.

— :99B: - Number Count

Instructions with a pool reference must include a pool counter indicating the total number of linked instructions.

SETT: Mandatory if the pool reference in the Optional Repetitive Subsequence A1 Linkages is filled.

TOSE: Mandatory if the pool reference in the Optional Repetitive Subsequence A1 Linkages is filled.

External-CSD Settlement and multicurrency settlement instructions: Linking of instructions is not possible.

— :22F: - Linkage Type Indicator

AFTE: Current instruction will be settled AFTER the linked-to instruction.

BEFO: Current instruction will be settled BEFORE the linked-to instruction.

WITH: Current instruction will be settled together WITH the linked-to instruction.

INFO: The LINK is added for informational purposes only and has no effects on the processing.

External-CSD Settlement and multicurrency settlement instructions: Linking of instructions is not possible.

Optional Repetitive Subsequence A1 Linkages

— :20C: - Reference

RELA: Customer reference of the referenced instruction (if A1:22F:LINK exists in this subsequence).

PREV: Customer reference of the instruction to be cancelled (in case of A:23G:CANC).

PREA: Customer reference of the instruction with PREA function (in case of A:23G:NEWM).

POOL: A pool reference can be used to link more than two instructions. It is a collective reference for a set of settlement instructions which must be settled collectively *"all-or-none"*.

COMM: Unique reference agreed between two counterparties to identify the instruction.

PCTI: In case of cancellation orders for instructions where the instructing party is different from the instructing party of the instruction being cancelled, this field has to contain the PCTI reference from the MT 548 status message.

- Instructions, which have been created by the OeKB CSD as instructing party (e.g. market claim or transformation)
- Instructions, which have been created by an authorised party but which are cancelled by the securities account owner

In addition the field :20C::PREV must be filled in with NONREF, because according to ISO 15022 SWIFT standard field :20C::PREV must be present, if field :23G: is CANC.

Mandatory Sequence B Trade Details

— :98A: - Date/Time

SETT: It is no longer possible to specify the exact time on the settlement day.

- :22F: - Priority Indicator

PRIR: When prioritising instructions it is possible to choose from 2 priority levels: High Priority (0003) and Normal Priority (0004). For details, please see *Annex 8 Guideline Settlement and Securities Account Administration*.

External-CSD Settlement: Prioritising of instructions is not possible.

- :22F: - Trade Transaction Condition Indicator

TTCO: This qualifier specifies whether the security is delivered with (CCPN – Cum Coupon) or without (XCPN – Ex Coupon) coupon (additional matching field).

External-CSD Settlement: This indicator is not used.

Mandatory Sequence C Financial Instrument/Account

- :36B: - Quantity

PFDD and PFDC: For payments or credits without delivery this field must be filled with "0".

- :97A: Safekeeping Account

The securities account number can be specified in the old format (e.g. 123400) or in the new format "OCSD + existing securities account number" (e.g. OCSD123400).

- :97A: - Cash Account

A safekeeping account can have assigned several DCAs (Dedicated Cash Account) in T2S. One of them is flagged as the default DCA. To use a different DCA than the default DCA for an instruction this field must contain the corresponding DCA.

In case of multicurrency settlement instructions cash settlement is carried out on multicurrency accounts (commercial bank cash accounts) held with OeKB. For each currency a securities account has assigned a default account, which is used for multicurrency instructions.

Optional Repetitive Subsequence C1 Quantity Breakdown

- :13B: - Lot Number

LOTS: To use a blocked/reserved position for an instruction this field must contain the restriction reference number.

External-CSD Settlement and multicurrency settlement instructions: This subsequence is not used.

Mandatory Sequence E Settlement Details

- :22F: - Settlement Transaction Condition Indicator

NPAR: Partial settlement of an instruction is not allowed.

PART: Partial settlement of an instruction is allowed.

PARQ: Partial Settlement is allowed with Minimum Quantity

PARC: Partial Settlement is allowed with Minimum Cash Value

NOMC: Opt-out indicator (additional matching field).

BSSP: Instruction Resulting from Partially Successful Buy-In. If the matching instruction is also instructed with this Settlement Transaction Condition both instructions will be exempt from Late Matching penalty fees. It is not a matching field.

For details, please see *Annex 8 Guideline Settlement and Securities Account Administration*.

External-CSD Settlement and multicurrency settlement instructions: Partial settlement is not possible.

— :22F: - Securities Sub-balance Type Indicator

SSBT: For this qualifier the use of Data Source Scheme "RT" (:4!c/RT/4!c) is compulsory.

For codes BLOn, RESn and EARn the rule "1<=n<=9", e.g. BLO1, BLO2, ..., BLO9 applies. If SSBT is used a position with the corresponding restriction type (e.g. BLO1) must e.

Mandatory Repetitive Subsequence E1 Settlement Parties

— :95P: - Place of Settlement

PSET: For identification the BIC of the counterparty (depository) is used as the sole reference.

Exception: Transaction type external-CSD settlement – in this case the place of settlement must be specified as at present.

— :95P: - Receiving Agent

This field is used to identify the counterparty using the BIC.

— :97A: - Safekeeping Account

For transaction type external-CSD settlement this field must contain the securities account number as at present.

— :95a: - Receiver's Intermediary 2/Receiver's Intermediary 1/Receiving Custodian/ Buyer

It is possible to send all 5 parties (incl. REAG). Please note, however, that except in the case of REAG the following sequence must be observed for the parties: REI2, REI1, RECU, BUYR.

It is possible to shorten the chain, e.g. only BUYR or only REI1, RECU, BUYR but the sequence must be observed in all cases.

— :95a: - Deliverer's Intermediary 2/Deliverer's Intermediary 1/Deliverer's Custodian/ Seller

Aside from the optional DEAG, 4 additional parties can be specified on the deliverer side. For these 4 additional parties the following sequence must be observed: DEI2, DEI1, DECU, SELL.

It is possible to shorten the chain, e.g. only SELL or only DEI1, DECU, SELL but the sequence must be observed in all cases.

Mandatory Repetitive Subsequence E3 Amount

— :19A: - Settlement Amount

The cash amount can be specified in Euro or in foreign currency.

DWP – Delivery with Payment: To debit the amount from the account, although normally this instruction would credit the amount to the account, use a negative sign [N] in this field.

PFDD: In case of a payment free of delivery (Sequence C :36B::SETT = 0) this field must be provided with a negative sign.

PFDC: In case of a credit free of delivery (Sequence C :36B::SETT = 0) this field must be provided unsigned.

1.4.1.8.3 MT543 Examples

Transaction Type Intra-CSD Settlement

Two OeKB CSD customers trade an AT ISIN versus payment.

— The instruction was submitted by the OeKB CSD customer with securities account number OCSD237400.

— The counterparty is the OeKB CSD customer with BIC SLHYAT2SXXX.

```

:16R:GENL
:20C::SEME//DVP10000
:23G:NEWM
:16S:GENL
:16R:TRADDET
:98A::TRAD//20160303
:98A::SETT//20160307
:35B:ISIN AT000BSP0000
BEISPIEL AG
:16S:TRADDET
:16R:FIAC
:36B::SETT//UNIT/1000,
:97A::SAFE//OCSD237400
:16S:FIAC
:16R:SETDET
:22F::SETR//TRAD
:16R:SETPRTY
:95P::PSET//OCSDATWWXXX
:16S:SETPRTY
:16R:SETPRTY
:95P::REAG//SLHYAT2SXXX
:97A:SAFE//OCSD224400
:16S:SETPRTY
:16R:AMT
:19A::SETT//EUR100,10

```

:16S:AMT
:16S:SETDET

Transaction Type Intra-CSD Settlement

Two OeKB CSD customers trade an AT ISIN versus payment.

- The instruction was submitted by the OeKB CSD customer with securities account number OCSD225100.
- The counterparty is the OeKB CSD customer with BIC WOODCZPPXXX. In this transaction WOOD acts on behalf of its customer, Ceska Sporitelna.

:16R:GENL
:20C::SEME//00002
:23G:PREA
:16S:GENL
:16R:TRADDET
:98A::TRAD//20131025
:98A::SETT//20131030
:35B:ISIN AT000BSP0002
4,25 % BEISPIEL 2
:16S:TRADDET
:16R:FIAC
:36B::SETT//FAMT/500000,
:97A::SAFE//OCSD225100
:16S:FIAC
:16R:SETDET
:22F::SETR//TRAD
:16R:SETPRTY
:95P::PSET//OCSDATWWXXX
:16S:SETPRTY
:16R:SETPRTY
:95P::REAG//WOODCZPPXXX
:16S:SETPRTY
:16R:SETPRTY
:95Q::BUYR//CESKA SPORITELNA
:16S:SETPRTY
:16R:AMT
:19A::SETT//EUR50956,20
:16S:AMT
:16S:SETDET

Transaction Type Intra-CSD Settlement

Two OeKB CSD customers trade a DE ISIN versus payment.

- The instruction was submitted by the OeKB CSD customer with securities account number OCSD227200.
- The counterparty is the OeKB CSD customer with BIC BKAUATWWXXX.

- The instruction shall be settled after (AFTE) instructions ABC123456 and ABC123457 but before (BEFO) instruction ABC123458 and together with (WITH) ABC123459.

:16R:GENL
:20C::SEME//00003
:23G:NEWM
:16R:LINK
:22F::LINK//AFTE
:20C::RELA//ABC123456
:16S:LINK
:16R:LINK
:22F::LINK//AFTE
:20C::RELA//ABC123457
:16S:LINK
:16R:LINK
:22F::LINK//BEFO
:20C::RELA//ABC123458
:16S:LINK
:16R:LINK
:22F::LINK//WITH
:20C::RELA//ABC123459
:16S:LINK
:16S:GENL
:16R:TRADDET
:98A::TRAD//20131025
:98A::SETT//20131030
:35B:ISIN DE000BSP0003
BEISPIEL 3 AG
:16S:TRADDET
:16R:FIAC
:36B::SETT//UNIT/100,
:97A::SAFE//OCSD227200
:16S:FIAC
:16R:SETDET
:22F::SETR//TRAD
:16R:SETPRTY
:95P::PSET//OCSDATWWXXX
:16S:SETPRTY
:16R:SETPRTY
:95P::REAG//BKAUATWWXXX
:16S:SETPRTY
:16R:AMT
:19A::SETT//EUR999,10
:16S:AMT
:16S:SETDET

Transaction Type Cross-CSD Settlement

A OeKB CSD customer and a Clearstream Banking Frankfurt customer trade a DE ISIN versus payment. Both central securities depositories are counterparties within T2S.

- The instruction was submitted by the OeKB CSD customer with safekeeping account number OCSD222100.
- The counterparty is the Clearstream Banking Frankfurt customer with BIC DEUTDEFFXXX. In this transaction Deutsche Bank acts on behalf of its Vienna subsidiary.

:16R:GENL
:20C::SEME//00005
:23G:PREA
:16S:GENL
:16R:TRADDET
:98A::TRAD//20131025
:98A::SETT//20131030
:35B:ISIN DE000BSP0005
BEISPIEL 5 AG
:16S:TRADDET
:16R:FIAC
:36B::SETT//UNIT/100,
:97A::SAFE//OCSD222100
:16S:FIAC
:16R:SETDET
:22F::SETR//TRAD
:16R:SETPRTY
:95P::PSET//DAKVDEFFXXX
:16S:SETPRTY
:16R:SETPRTY
:95P::REAG//DEUTDEFFXXX
:16S:SETPRTY
:16R:SETPRTY
:95Q::BUYR//Deutsche Bank Wien
:16S:SETPRTY
:16R:AMT
:19A::SETT//EUR999,10
:16S:AMT
:16S:SETDET

Transaction Type Cross-CSD Settlement

A OeKB CSD customer and an Iberclear customer trade a DE ISIN versus payment. Both central securities depositories and the security depository are counterparties within T2S.

- The instruction was submitted by the OeKB CSD customer with safekeeping account number OCSD227600.
- The counterparty is the Iberclear customer with BIC COBAESMXTMA.

:16R:GENL
:20C::SEME//00006
:23G:NEWM
:16S:GENL
:16R:TRADEDET
:98A::TRAD//20131025
:98A::SETT//20131030
:35B:ISIN DE000BSP0006
BEISPIEL 6 AG
:16S:TRADEDET
:16R:FIAC
:36B::SETT//UNIT/100,
:97A::SAFE//OCSD227600
:16S:FIAC
:16R:SETDET
:22F::SETR//TRAD
:16R:SETPRTY
:95P::PSET//IBRCESMMXXX
:16S:SETPRTY
:16R:SETPRTY
:95P::REAG//COBAESMXTMA
:16S:SETPRTY
:16R:AMT
:19A::SETT//EUR999,10
:16S:AMT
:16S:SETDET

Transaction Type Intra-CSD Settlement

Two OeKB CSD customers trade an AT ISIN versus payment.

- The instruction was submitted by the OeKB CSD customer with securities account number OCSD227300.
- The counterparty is the OeKB CSD customer with BIC BAWAATWWXXX.
- The instruction has priority "High" (0003).
- If the instruction cannot be settled in full, partial settlement is possible (partial settlement allowed).
- The reserved position RES1 with restriction reference "T2SR1234" shall be used for this instruction.
- The instruction includes all settlement parties possible in a delivery chain.

:16R:GENL
:20C::SEME//EB00387621

:23G:NEWM
:16S:GENL
:16R:TRADEDET
:98A::TRAD//20140804
:98A::SETT//20140809
:35B:ISIN AT0000743059
:22F::PRIR//0003
:70E::SPRO//Additional text line 1
Additional text line 2
:16S:TRADEDET
:16R:FIAC
:36B::SETT//UNIT/1000,
:97A::SAFE//227300
:97A::CASH//123456
:16R:BREAK
:13B::LOTS//T2SR1234
:16S:BREAK
:16S:FIAC
:16R:SETDET
:22F::STCO//PART
:22F::SSBT/RT/RES1
:22F::SETR//TRAD
:16R:SETPRTY
:95P::PSET//OCSDATWWXXX
:16S:SETPRTY
:16R:SETPRTY
:95P::REAG//BAWAATWWXXX
:16S:SETPRTY
:16R:SETPRTY
:95R::REI2/BANKB/BANK C
:16S:SETPRTY
:16R:SETPRTY
:95R::REI1/BA/BANK B
:16S:SETPRTY
:16R:SETPRTY
:95R::RECU/AA/BANK A
:97A::SAFE//6789HIJK
:16S:SETPRTY
:16R:SETPRTY
:95Q::BUYR//BANK D
:16S:SETPRTY
:16R:SETPRTY
:95R::DEI2/BANKX/BANK Y
:97A::SAFE//4567XYZ

:16S:SETPRTY
:16R:SETPRTY
:95R::DEI1/XA/BANK X
:16S:SETPRTY
:16R:SETPRTY
:95R::DECU/WA/BANK W
:16S:SETPRTY
:16R:SETPRTY
:95Q::SELL//BANK Z
:97A::SAFE//1234ABCD
:16S:SETPRTY
:16R:AMT
:19A::SETT//EUR48000,
:16S:AMT
:16S:SETDET

1.4.2 Settlement Confirmations – MT544-547

1.4.2.1 MT544 – Receive Free Confirmation

MT544 is the settlement confirmation for receipt instructions free of payment (RFP).

1.4.2.1.1 Content

M/O	Tag	Field Name	Qualifier	Option	Format	Codes	Description
Mandatory Sequence A General Information							
M	:16R:	Start of Block			16c	GENL	
M	:20C:	Sender's Reference	SEME		:4!c//16x		Reference assigned by the sender to unambiguously identify the message
M	:23G:	Function of the Message			4!c	NEWM CANC	New message Message requesting the cancellation of a previously sent message.
M	:98C:	Preparation Date/Time	PREP		:4!c//8!n6!n		Date and time at which message was prepared.
O	:22F:	Partial Settlement Indicator	PARS		:4!c/[8c]/4!c	PAIN	Confirmation is for partial settlement. Part of the instruction remains unsettled.

M/O	Tag	Field Name	Qualifier	Option	Format	Codes	Description
						PARC	Confirmation is for partial settlement. No additional settlement will take place.
Optional Repetitive Subsequence A1 Linkages							
M	:16R:	Start of Block			16c	LINK	
M	:20C:	Reference	RELA		:4!c//16x		Related Message Reference
			MITI				T2S Market Infrastructure Transaction Identification
			COMM				Common Reference
			POOL				Pool Reference
			PREV				Reference of the linked message which was previously sent.
			CORP				Corporate Action Reference
			PCTI				Processor Transaction Identification
M	:16S:	End of Block			16c	LINK	
End of Subsequence A1 Linkages							
M	:16S:	End of Block			16c	GENL	
End of Sequence A General Information							
Mandatory Sequence B Trade Details							
M	:16R:	Start of Block			16c	TRADDET	
O	:94H:	Place of Clearing	CLEA		:4!c//4!a2!a2!c[3!c]		
O	:94B:	Place of Trade	TRAD		:4!c//4!c[/30x]	EXCH	Place of trade is a stock exchange
						OTCO	Place of trade is over the counter.
						PRIM	Place of trade is the primary market.
						SECM	Place of trade is the secondary market.

M/O	Tag	Field Name	Qualifier	Option	Format	Codes	Description
						VARI	Trade was executed on various places.
M	:98a:	Trade Date/Time	TRAD	A	:4!c//8!n		Date at which the trade was executed.
				C	:4!c//8!n6!n		Date and time at which the trade was executed.
M	:98C:	Effective Settlement Date/Time	ESET		:4!c//8!n6!n		Date and time at which a transaction effectively settled.
O	:98A:	Settlement Date	SETT		:4!c//8!n		Date at which the financial instruments are to be delivered or received.
M	:35B:	Identification of the Financial Instrument			ISIN1!e12!c		"ISIN" followed by <Blank> and ISIN Code
O	:22F:	Priority Indicator	PRIR		:4!c//4!c	0001	Priority set by CSD or NCBs
						0002	Top priority (can only be assigned to trading platforms (MTFs, stock exchanges, etc.)
						0003	High priority
						0004	Normal priority
O	:22F:	Trade Transaction Condition Indicator	TTCO		:4!c//4!c	CCPN	Trade was executed cum bonus.
						XCPN	Trade was executed ex coupon.
O	:70E:	Narrative	SPRO		:4!c//10*35x		Provides additional settlement processing information which cannot be included within the structured fields of the message.
M	:16S:	End of Block			16c	TRADEDET	
End of Sequence B Trade Details							
Mandatory Sequence C Financial Instrument/Account							
M	:16R:	Start of Block			16c	FIAC	

M/O	Tag	Field Name	Qualifier	Option	Format	Codes	Description
M	:36B:	Quantity of Financial Instrument Settled	ESTT		:4!c//4!c/15d	FAMT UNIT	Face amount Unit number
O	:36B:	Quantity of Financial Instrument Previously Settled	PSTT		:4!c//4!c/15d	FAMT UNIT	Face amount Unit number
O	:36B:	Quantity of Financial Instrument remaining to be settled.	RSTT		:4!c//4!c/15d	FAMT UNIT	Face amount Unit number
M	:97A:	Safekeeping Account	SAFE		:4!c//35x		OeKB CSD's securities account number of the customer
M	:16S:	End of Block			16c	FIAC	

[End of Sequence C Financial Instrument/Account](#)

[Mandatory Sequence E Settlement Details](#)

M	:16R:	Start of Block			16c	SETDET	
M	:22F:	Type of Settlement Transaction	SETR		:4!c/[8!c]/4!c	CLAI COLI COLO TRAD AUTO CORP	Transaction resulting from a market claim. Relates to a collateral transaction, from the point of view of the collateral taker or its agent. Relates to a collateral transaction, from the point of view of the collateral giver or its agent. Type of Settlement Transaction Indicator Auto-collateralisation, in case of an Intra-day Restriction on the eligible ISIN Relates to a transaction generated as a result of a corporate action

M/O	Tag	Field Name	Qualifier	Option	Format	Codes	Description
						REBL	Rebalancing
O	:22F:	Settlement Transaction Condition Indicator	STCO		:4!c/[8c]/4!c	NPAR	Partial settlement is not allowed.
						PART	Partial settlement is allowed.
						NOMC	No market claim should be automatically generated.
						TRAN	Transaction resulting from a transformation.
					:4!c/COEX/4!c	PARQ	Partial Settlement is Allowed with Minimum Quantity
						PARC	Partial Settlement is Allowed with Minimum Cash Value
					:4!c/REGL/4!c	BSSP	Instruction Resulting from Partially Successful Buy-In
O	:22F:	Securities Sub-balance Type Indicator	SSBT		:4!c/[8c]/4!c	EEUR	Earmarking for autocoll.
						EAR <i>n</i>	Other earmarking
O	:22F:	Beneficial Ownership Indicator	BENE		:4!c/[8c]/4!c	NBEN	No Change of Beneficial Ownership (NCBO)
						YBEN	Change of Beneficial Ownership (CBO)
Mandatory Repetitive Subsequence E1 Settlement Parties							
M	:16R:	Start of Block			16c	SETPRTY	
M	:95P:	Place of Settlement	PSET		:4!c//4!a2!a2!c[3!c]		Place of settlement (depository)
M	:16S:	End of Block			16c	SETPRTY	
M	:16R:	Start of Block			16c	SETPRTY	
M	:95P:	Delivering Agent	DEAG		:4!c//4!a2!a2!c[3!c]		Delivering party that interacts with the place of settlement

M/O	Tag	Field Name	Qualifier	Option	Format	Codes	Description
(M)	:97A:	Safekeeping Account	SAFE		4!c//35x		Counterparty's securities acc. number
O	:20C:	Processing Reference	PROC		:4!c//16x		Counterparty's customer reference (not present for External Instructions)
M	:16S:	End of Block			16c	SETPRTY	
O	:16R:	Start of Block			16c	SETPRTY	
O	:95a:	Deliverer's Intermediary 2	DEI2	P	:4!c//4!a2!a2!c[3!c]		Party that interacts with the deliverer's intermediary 1
				R	:4!c/8!c/34x		
				Q	:4!c//4*35x		
O	:16S:	End of Block			16c	SETPRTY	
O	:16R:	Start of Block			16c	SETPRTY	
O	:95a:	Deliverer's Intermediary 1	DEI1	P	:4!c//4!a2!a2!c[3!c]		Party that interacts with the delivering agent
				R	:4!c/8!c/34x		
				Q	:4!c//4*35x		
O	:16S:	End of Block			16c	SETPRTY	
O	:16R:	Start of Block			16c	SETPRTY	
O	:95a:	Deliverer's Custodian	DECU	P	:4!c//4!a2!a2!c[3!c]		Party that interacts with the delivering agent unless intermediaries exist
				R	:4!c/8!c/34x		
				Q	:4!c//4*35x		
O	:16S:	End of Block			16c	SETPRTY	
O	:16R:	Start of Block			16c	SETPRTY	
O	:95a:	Seller	SELL	P	:4!c//4!a2!a2!c[3!c]		Party that delivers the financial instrument
				R	:4!c/8!c/34x		
				Q	:4!c//4*35x		
O	:16S:	End of Block			16c	SETPRTY	
O	:16R:	Start of Block			16c	SETPRTY	
O	:95P:	Receiving Agent	REAG		:4!c//4!a2!a2!c[3!c]		Receiving party that interacts with the place of settlement.
O	:16S:	End of Block			16c	SETPRTY	

M/O	Tag	Field Name	Qualifier	Option	Format	Codes	Description
O	:95a:	Receiver's Intermediary 2	REI2	P	:4!c//4!a2!a2!c[3!c]		Party that interacts with the receiver's intermediary 1
				R	:4!c/8!c/34x		
				Q	:4!c//4*35x		
O	:16S:	End of Block			16c	SETPRTY	
O	:16R:	Start of Block			16c	SETPRTY	
O	:95a:	Receiver's Intermediary 1	REI1	P	:4!c//4!a2!a2!c[3!c]		Party that interacts with the receiving agent
				R	:4!c/8!c/34x		
				Q	:4!c//4*35x		
O	:16S:	End of Block			16c	SETPRTY	
O	:16R:	Start of Block			16c	SETPRTY	
O	:95a:	Receiver's Custodian	RECU	P	:4!c//4!a2!a2!c[3!c]		Party that interacts with the receiving agent unless intermediaries exist
				R	:4!c/8!c/34x		
				Q	:4!c//4*35x		
O	:16S:	End of Block			16c	SETPRTY	
O	:16R:	Start of Block			16c	SETPRTY	
O	:95a:	Buyer	BUYR	P	:4!c//4!a2!a2!c[3!c]		Party that receives the financial instrument
				R	:4!c/8!c/34x		
				Q	:4!c//4*35x		
M	:16S:	End of Block			16c	SETPRTY	
End of Subsequence E1 Settlement Parties							
M	:16S:	End of Block			16c	SETDET	
End of Sequence E Settlement Details							

1.4.2.1.2 Explanation of the SWIFT Fields

Sequence A – General Information

— :22F: - Partial Settlement Indicator

PAIN: This indicator is sent with messages where only partial settlement of the instruction was possible.

PARC: This indicator is sent with the last message to confirm that the last remaining part was settled.

Optional Repetitive Subsequence A1 Linkages

— :20C: - Reference

RELA: This field contains the customer reference of the MT543 SWIFT message that was sent

MITI: Unique transaction reference of T2S.

COMM: Unique reference agreed between the two counterparties.

POOL: Reference identifying a group of messages.

PREV: This field contains the message reference of the message which was previously sent.

CORP: Reference assigned by the OeKB CSD to identify a relevant corporate action.

PCTI: This field contains the customer reference, if the instructing party differs from the account owner party. In this case the field RELA contains "NONREF". Exception: transaction type Physical (Issuer Services Reference), multicurrency instructions, transaction type External-CSD.

Mandatory Sequence B Trade Details

— :98C: - Effective Settlement Date/Time

Date and time¹ of the effective settlement date.

— :35B: - Identification of the Financial Instrument

This field only contains the ISIN. The security name is no longer specified.

— :22F: - Priority Indicator

PRIR: The priority by which a transaction (an instruction pair) is settled, is determined by the instruction with the higher priority. For settlement instructions it is possible to choose from 2 priority levels - High Priority (0003) and Normal Priority (0004). Priority level 0001 (Reserved) is reserved for CSDs and central banks. Priority level 0002 (Top Priority) is reserved for stock exchanges, MTFs, and CCPs.

— :70E: - Narrative

SPRO: In case of an instruction created via auto receive this field contains "Auto received".

Mandatory Sequence C Financial Instrument/Account

— :36B: - Quantity of Financial Instrument Settled

ESTT: The actual quantity of securities settled. In case of partial settlement the settled part is indicated. This field is 0 for PFRC, PFRD, PFDC and PFDD instructions.

— :36B: - Quantity of Financial Instrument Previously Settled

PSTT: In case of partial settlement the part that was already settled.

— :36B: - Quantity of Financial Instrument Remaining to be Settled

RSTT: In case of partial settlement the part that was not yet settled.

¹ The current time is provided, which also applies to confirmations in NTS (until midnight) - the settlement date is already the date of the next day!

Mandatory Sequence E Settlement Details

— :22F: Type of Settlement Transaction

CLAI: Used for an instruction resulting from a market claim.

COLI: Used for a collateral instruction (credit provider).

COLO: Used for a collateral instruction (credit consumer).

TRAD: Used for a standard settlement instruction.

AUTO: Instruction was generated automatically in the course of auto-collateralisation.

CORP: Instruction was generated automatically in the course of a corporate action.

— :22F: Settlement Transaction Condition Indicator

NPAR: Partial settlement of an instruction is not allowed.

PART: Partial settlement of an instruction is allowed.

PARQ: Partial Settlement is allowed with Minimum Quantity

PARC: Partial Settlement is allowed with Minimum Cash Value

NOMC: Opt-out indicator.

BSSP: Instruction Resulting from Partially Successful Buy-In. If the matching instruction is also instructed with this Settlement Transaction Condition both instructions will be exempt from Late Matching penalty fees. It is not a matching field.

This field is filled as received in the MT543 or MT530 SWIFT message.

For details, please see *Annex 8 Guideline Settlement and Securities Account Administration*.

— :22F: - Securities Sub-balance Type Indicator

SSBT: For this qualifier the use of Data Source Scheme "RT" (:4!c/RT/4!c) is compulsory.

For code EARn the rule "1<=n<=9", e.g. EAR1, EAR2, ..., EAR9 applies.

This field is filled as received in the MT540 SWIFT message.

Mandatory Repetitive Subsequence E1 Settlement Parties

— :95P: - Delivering Agent

This field is used to identify the counterparty using the BIC. It is filled as received in the MT540 SWIFT message.

— :95a: - Deliverer's Intermediary 2/Deliverer's Intermediary 1/Deliverer's Custodian/ Seller

These fields are filled as received in the MT540 SWIFT message.

- :95a: - Receiving Agent/Receiver's Intermediary 2/Receiver's Intermediary 1/Receiving Custodian/ Buyer
These fields are filled as received in the MT540 SWIFT message

1.4.2.1.3 MT544 Examples

Transaction Type Intra-CSD Settlement

Settlement confirmation for the MT540 example with customer reference "00001". Free of payment transfer of an AT ISIN between two OeKB CSD customers.

- The instruction was submitted by the OeKB CSD customer with securities account number OCSD227200.
- The counterparty is the OeKB CSD customer with BIC BKAUATWWXXX.
- The instruction was settled on the intended settlement date.

```

:16R:GENL
:20C::SEME//CSDA000003
:23G:NEWM
:98C::PREP//20131030012743
:16R:LINK
:20C::RELA//00001
:16S:LINK
:16R:LINK
::20C::MITI//T2SREF001
:16S:LINK
:16S:GENL
:16R:TRADDET
:98A::TRAD//20131025
:98C::ESET//20131030012645
:98A::SETT//20131030
:35B:ISIN AT000BSP0001
:16S:TRADDET
:16R:FIAC
:36B::ESTT//UNIT/100,
:97A::SAFE//OCSD227200
:16S:FIAC
:16R:SETDET
:22F::SETR//TRAD
:16R:SETPRTY
:95P::PSET//OCSDATWWXXX
:16S:SETPRTY
:16R:SETPRTY
:95P::DEAG//BKAUATWWXXX
:20C::PROC//CPTYCUSTREF12345
:16S:SETPRTY
:16S:SETDET

```

Transaction Type Intra-CSD Settlement with Earmarking

Settlement confirmation of a free of payment transfer of an AT ISIN between two OeKB CSD customers. The delivered position is flagged "earmarked".

- The instruction was submitted by the OeKB CSD customer with securities account number OCSD227600.
- The counterparty is the OeKB CSD customer with BIC BKAUATWWXXX.

:16R:GENL
:20C::SEME//CSDA0022
:23G:NEWM
:98C::PREP//20140701091010
:16R:LINK
:20C::RELA//00002
:16S:LINK
:16R:LINK
:20C::MITI//T2SREF00002
:16S:LINK
:16S:GENL
:16R:TRADDET
:98A::TRAD//20140630
:98C::ESET//20140701090500
:98A::SETT//20140701
:35B:ISIN AT0000A105W3
:16S:TRADDET
:16R:FIAC
:36B::ESTT//UNIT/100000,
:97A::SAFE//OCSD227600
:16S:FIAC
:16R:SETDET
:22F::SETR//TRAD
:22F::SSBT/RT/EEUR
:16R:SETPRTY
:95P::PSET//OCSDATWWXXX
:16S:SETPRTY
:16R:SETPRTY
:95P::DEAG//BKAUATWWXXX
:20C::PROC//CPTYCUSTREF12345
:16S:SETPRTY
:16R:SETPRTY
:95Q::SELL//Generali Bank
:16S:SETPRTY
:16S:SETDET

MT544 created via Auto Receive

:16R:GENL

:20C::SEME//1029641107000
:23G:NEWM
:98C::PREP//20161114203733
:16R:LINK
:20C::RELA//EA0000000009B412
:16S:LINK
:16R:LINK
:20C::MITI//1611140147666113
:16S:LINK
:16S:GENL
:16R:TRADDET
:98A::TRAD//20161114
:98C::ESET//20161115203327
:98A::SETT//20161114
:35B:ISIN AT0000818802
:70E::SPRO//Auto received
:16S:TRADDET
:16R:FIAC
:36B::ESTT//UNIT/1,
:97A::SAFE//OCSD081500
:16S:FIAC
:16R:SETDET
:22F::SETR//TRAD
:22F::STCO//NPAR
:16R:SETPRTY
:95P::PSET//OCSDATWWXXX
:16S:SETPRTY
:16R:SETPRTY
:95P::DEAG//BKAUATWWXXX
:97A::SAFE//OCSD222100
:20C::PROC//CPTYCUSTREF12345
:16S:SETPRTY
:16R:SETPRTY
:95P::REAG//SLHYAT2SXXX
:97A::SAFE//OCSD081500
:16S:SETPRTY
:16S:SETDET

1.4.2.2 MT545 – Receive Against Payment Confirmation

MT545 is the settlement confirmation for receipt instructions versus payment MT541 (RVP), for receipt with payment (RWP) and for payments free of receipt (PFRD) and for credits free of receipt (PFRC). Since External instructions can only be Free of Payment there can be no MT545 for External Instructions.

Multicurrency settlement instructions: only RVP.

1.4.2.2.1 Content

M/O	Tag	Field Name	Qualifier	Option	Format	Codes	Description
Mandatory Sequence A General Information							
M	:16R:	Start of Block			16c	GENL	
M	:20C:	Sender's Reference	SEME		:4!c//16x		Reference assigned by the sender to unambiguously identify the message
M	:23G:	Function of the Message			4!c	NEWM	New message
						CANC	Message requesting the cancellation of a previously sent message.
M	:98C:	Preparation Date/Time	PREP		:4!c//8!n6!n		Date and time at which message was prepared.
O	:22F:	Partial Settlement Indicator	PARS		:4!c/[8c]/4!c	PAIN	Confirmation is for partial settlement. Part of the instruction remains unsettled.
						PARC	Confirmation is for partial settlement. No additional settlement will take place.
Optional Repetitive Subsequence A1 Linkages							
M	:16R:	Start of Block			16c	LINK	
M	:20C:	Reference	RELA		:4!c//16x		Related Message Reference
			MITI			T2S Market Infrastructure Transaction Identification	
			COMM			Common Reference	
			POOL			Pool Reference	
			PREV			Reference of the linked message which was previously sent.	
			CORP			Corporate Action Reference	
			PCTI			Processor Transaction Identification	

M/O	Tag	Field Name	Qualifier	Option	Format	Codes	Description
M	:16S:	End of Block			16c	LINK	
End of Subsequence A1 Linkages							
M	:16S:	End of Block			16c	GENL	
End of Sequence A General Information							
Mandatory Sequence B Trade Details							
M	:16R:	Start of Block			16c	TRADD ET	
O	:94H:	Place of Clearing	CLEA		:4!c//4!a2!a2!c[3!c]		
O	:94B:	Place of Trade	TRAD		:4!c//4!c[30x]	EXCH OTCO PRIM SECM VARI	Place of trade is a stock exchange Place of trade is over the counter. Place of trade is the primary market. Place of trade is the secondary market. Trade was executed on various places.
O	:98a:	Trade Date/Time	TRAD	A C	:4!c//8!n :4!c//8!n6!n		Date at which the trade was executed. Date and time at which the trade was executed.
M	:98C:	Effective Settlement Date/Time	ESET		:4!c//8!n6!n		Date and time at which a transaction effectively settled.
O	:98A:	Settlement Date	SETT		:4!c//8!n		Date at which the financial instruments are to be delivered or received.
M	:35B:	Identification of the Financial Instrument			ISIN1!e12!c		"ISIN" followed by <Blank> and ISIN Code
O	:22F:	Priority Indicator	PRIR		:4!c//4!c	0001 0002	Priority set by CSD or NCBs Top priority (can only be assigned to trading platforms (MTFs, stock exchanges, etc.)

M/O	Tag	Field Name	Qualifier	Option	Format	Codes	Description
						0003	High priority
						0004	Normal priority
O	:22F:	Trade Transaction Condition Indicator	TTCO		:4!c//4!c	CCPN	Trade was executed cum bonus.
						XCPN	Trade was executed ex coupon.
O	:70E:	Narrative	SPRO		:4!c//10*35x		Provides additional settlement processing information which cannot be included within the structured fields of the message.
M	:16S:	End of Block			16c	TRADD ET	

End of Sequence B Trade Details

Mandatory Sequence C Financial Instrument/Account

M	:16R:	Start of Block			16c	FIAC	
M	:36B:	Quantity of Financial Instrument Settled	ESTT		:4!c//4!c/15d	FAMT	Face amount
						UNIT	Unit number
O	:36B:	Quantity of Financial Instrument Previously Settled	PSTT		:4!c//4!c/15d	FAMT	Face amount
						UNIT	Unit number
O	:36B:	Quantity of Financial Instrument remaining to be settled.	RSTT		:4!c//4!c/15d	FAMT	Face amount
						UNIT	Unit number
O	:19A:	Previously Settled Amount	PSTT		:4!c//[N]3!a15d		
O	:19A:	Remaining Settlement Amount	RSTT		:4!c//[N]3!a15d		
M	:97A:	Safekeeping Account	SAFE		:4!c//35x		OeKB CSD's securities account number of the customer
O	:97A:	Cash Account	CASH		:4!c//35x		Account in which cash is maintained

M/O	Tag	Field Name	Qualifier	Option	Format	Codes	Description
M	:16S:	End of Block			16c	FIAC	
End of Sequence C Financial Instrument/Account							
Mandatory Sequence E Settlement Details							
M	:16R:	Start of Block			16c	SETDE T	
M	:22F:	Type of Settlement Transaction	SETR		:4!c/[8!c]/4!c	CLAI	Transaction resulting from a market claim.
						COLI	Relates to a collateral transaction, from the point of view of the collateral taker or its agent.
						COLO	Relates to a collateral transaction, from the point of view of the collateral giver or its agent.
						TRAD	Type of Settlement Transaction Indicator
				:4!c/COEX/4!c	AUTO	Auto-collateralisation, in case of an Intra-day Restriction on the eligible ISIN	
					CORP	Relates to a transaction generated as a result of a corporate action	
O	:22F:	Settlement Transaction Condition Indicator	STCO		:4!c/[8!c]/4!c	NPAR	Partial settlement is not allowed.
						PART	Partial settlement is allowed.
						NOMC	No market claim should be automatically generated.
						TRAN	Transaction resulting from a transformation.
							:4!c/COEX/4!c
		PARC	Partial Settlement is Allowed with Minimum Cash Value				

M/O	Tag	Field Name	Qualifier	Option	Format	Codes	Description
					:4!c/REGL/4!c	BSSP	Instruction Resulting from Partially Successful Buy-In
O	:22F:	Securities Sub-balance Type Indicator	SSBT		:4!c/[8c]/4!c	EEUR EAR <i>n</i>	Earmarking for autocoll. Other earmarking
O	:22F:	Beneficial Ownership Indicator	BENE		:4!c/[8c]/4!c	NBEN YBEN	No Change of Beneficial Ownership (NCBO) Change of Beneficial Ownership (CBO)
Mandatory Repetitive Subsequence E1 Settlement Parties							
M	:16R:	Start of Block			16c	SETPRT Y	
M	:95P:	Place of Settlement	PSET		:4!c//4!a2!a2!c[3!c]		Place of settlement (depository)
M	:16S:	End of Block			16c	SETPRT Y	
M	:16R:	Start of Block			16c	SETPRT Y	
M	:95P:	Delivering Agent	DEAG		:4!c//4!a2!a2!c[3!c]		Delivering party that interacts with the place of settlement
(M)	:97A:	Safekeeping Account	SAFE		4!c//35x		Counterparty's securities acc. number
O	:20C:	Processing Reference	PROC		:4!c//16x		Counterparty's customer reference
M	:16S:	End of Block			16c	SETPRT Y	
O	:16R:	Start of Block			16c	SETPRT Y	
O	:95a:	Deliverer's Intermediary 2	DEI2	P R Q	:4!c//4!a2!a2!c[3!c] :4!c/8!c/34x :4!c//4*35x		Party that interacts with the deliverer's intermediary 1
O	:16S:	End of Block			16c	SETPRT Y	
O	:16R:	Start of Block			16c	SETPRT Y	
O	:95a:		DEI1	P R	:4!c//4!a2!a2!c[3!c] :4!c/8!c/34x		

M/O	Tag	Field Name	Qualifier	Option	Format	Codes	Description
		Deliverer's Intermediary 1		Q	:4!c//4*35x		Party that interacts with the delivering agent
O	:16S:	End of Block			16c	SETPRT Y	
O	:16R:	Start of Block			16c	SETPRT Y	
O	:95a:	Deliverer's Custodian	DECU	P	:4!c//4!a2!a2!c[3!c]		Party that interacts with the delivering agent unless intermediaries exist
				R	:4!c/8!c/34x		
				Q	:4!c//4*35x		
O	:16S:	End of Block			16c	SETPRT Y	
O	:16R:	Start of Block			16c	SETPRT Y	
O	:95a:	Seller	SELL	P	:4!c//4!a2!a2!c[3!c]		Party that delivers the financial instrument
				R	:4!c/8!c/34x		
				Q	:4!c//4*35x		
O	:16S:	End of Block			16c	SETPRT Y	
O	:16R:	Start of Block			16c	SETPRT Y	
O	:95P:	Receiving Agent	REAG		:4!c//4!a2!a2!c[3!c]		Receiving party that interacts with the place of settlement.
O	:16S:	End of Block			16c	SETPRT Y	
O	:95a:	Receiver's Intermediary 2	REI2	P	:4!c//4!a2!a2!c[3!c]		Party that interacts with the receiver's intermediary 1
				R	:4!c/8!c/34x		
				Q	:4!c//4*35x		
O	:16S:	End of Block			16c	SETPRT Y	
O	:16R:	Start of Block			16c	SETPRT Y	
O	:95a:	Receiver's Intermediary 1	REI1	P	:4!c//4!a2!a2!c[3!c]		Party that interacts with the receiving agent
				R	:4!c/8!c/34x		
				Q	:4!c//4*35x		
O	:16S:	End of Block			16c	SETPRT Y	

M/O	Tag	Field Name	Qualifier	Option	Format	Codes	Description
O	:16R:	Start of Block			16c	SETPRT Y	
O	:95a:	Receiver's Custodian	RECU	P R Q	:4!c//4!a2!a2!c[3!c] :4!c/8!c/34x :4!c//4*35x		Party that interacts with the receiving agent unless intermediaries exist
O	:16S:	End of Block			16c	SETPRT Y	
O	:16R:	Start of Block			16c	SETPRT Y	
O	:95a:	Buyer	BUYR	P R Q	:4!c//4!a2!a2!c[3!c] :4!c/8!c/34x :4!c//4*35x		Party that receives the financial instrument
M	:16S:	End of Block			16c	SETPRT Y	

End of Subsequence E1 Settlement Parties

Optional Repetitive Subsequence E2 Cash Parties

M	:16R:	Start of Block			16c	CSHPR TY	
M	:95P:	Party	BENM		:4!c//4!a2!a2!c[3!c]		BIC of Beneficiary of Money
M	:97A:	Account	CASH		:4!c//34x		Account in which cash is maintained.
M	:16S:	End of Block			16c	CSHPR TY	

End of Subsequence E2 Cash Parties

Mandatory Repetitive Subsequence E3 Amount

M	:16R:	Start of Block			16c	AMT	
M	:19A:	Settled Amount	ESTT		:4!c//[N]3!a15d		ISO-Currency code followed by cash amount
M	:16S:	End of Block			16c	AMT	
O	:16R:	Start of Block			16c	AMT	
O	:19A:	Other Amount	OTHR		:4!c//[N]3!a15d		ISO-Currency code followed by amount of penalty interest on arrears
M	:16S:	End of Block			16c	AMT	

M/O	Tag	Field Name	Qualifier	Option	Format	Codes	Description
End of Subsequence E3 Amount							
M	:16S:	End of Block			16c	SETDE T	
End of Sequence E Settlement Details							

1.4.2.2.2 Explanation of the SWIFT Fields

Sequence A – General Information

— :22F: - Partial Settlement Indicator

PAIN: This indicator is sent with messages where only partial settlement of the instruction was possible.

PARC: This indicator is sent with the last message to confirm that the last remaining part was settled.

Optional Repetitive Subsequence A1 Linkages

— :20C: - Reference

RELA: This field contains the customer reference of the MT543 SWIFT message that was sent.

MITI: Unique transaction reference of T2S.

COMM: Unique reference agreed between the two counterparties.

POOL: Reference identifying a group of messages.

PREV: This field contains the message reference of the message which was previously sent.

CORP: Reference assigned by the OeKB CSD to identify a relevant corporate action.

PCTI: This field contains the customer reference, if the instructing party differs from the account owner party. In this case the field RELA contains "NONREF". Exception: transaction type Physical (Issuer Services Reference), multicurrency instructions

Mandatory Sequence B Trade Details

— :98C: - Effective Settlement Date/Time

Date and time² of the effective settlement date.

— :35B: - Identification of the Financial Instrument

This field only contains the ISIN. The security name is no longer specified.

— :22F: - Priority Indicator

² The current time is provided, which also applies to confirmations in NTS (until midnight) - the settlement date is already the date of the next day!

PRIR: The priority, by which a transaction (an instruction pair) is settled, is determined by the instruction with the higher priority. For settlement instructions it is possible to choose from 2 priority levels: High Priority (0003) and Normal Priority (0004). Priority level 0001 (Reserved) is reserved for CSDs and central banks. Priority level 0002 (Top Priority) is reserved for stock exchanges, MTFs, and CCPs.

Mandatory Sequence C Financial Instrument/Account

— :36B: - Quantity of Financial Instrument Settled

ESTT: The actual quantity of securities settled. In case of partial settlement the settled part is indicated.

— :36B: - Quantity of Financial Instrument Previously Settled

PSTT: In case of partial settlement the part that was already settled.

— :36B: - Quantity of Financial Instrument Remaining to be Settled

RSTT: In case of partial settlement the part that was not yet settled.

— :19A: - Previously Settled Amount

PSTT: In case of partial settlement the cash amount that was already settled.

— :19A: - Remaining Settlement Amount

RSTT: In case of partial settlement the cash amount that was not yet settled.

Mandatory Sequence E Settlement Details

— :22F: Type of Settlement Transaction

CLAI: Used for an instruction resulting from a market claim.

COLI: Used for a collateral instruction (credit provider).

COLO: Used for a collateral instruction (credit consumer).

TRAD: Used for a standard settlement instruction.

AUTO: Instruction was generated automatically in the course of auto-collateralisation.

CORP: Instruction was generated automatically in the course of a corporate action.

— :22F: Settlement Transaction Condition Indicator

NPAR: Partial settlement of an instruction is not allowed.

PART: Partial settlement of an instruction is allowed.

PARQ: Partial Settlement is allowed with Minimum Quantity

PARC: Partial Settlement is allowed with Minimum Cash Value

NOMC: Opt-out indicator.

BSSP: Instruction Resulting from Partially Successful Buy-In. If the matching instruction is also instructed with this Settlement Transaction Condition both instructions will be exempt from Late Matching penalty fees. It is not a matching field.

This field is filled as received in the MT541 or MT530 SWIFT message.

For details, please see *Annex 8 Guideline Settlement and Securities Account Administration*.

— :22F: - Securities Sub-balance Type Indicator

SSBT: For this qualifier the use of Data Source Scheme "RT" (:4!c/RT/4!c) is compulsory.

For code EARn the rule "1<=n<=9", e.g. EAR1, EAR2, ..., EAR9 applies.

This field is filled as received in the MT541 SWIFT message.

Mandatory Repetitive Subsequence E1 Settlement Parties

— :95P: - Delivering Agent

This field is used to identify the counterparty using the BIC. It is filled as received in the MT541 SWIFT message.

— :95a: - Deliverer's Intermediary 2/Deliverer's Intermediary 1/Deliverer's Custodian/ Seller

These fields are filled as received in the MT541 SWIFT message.

— :95a: - Receiving Agent/Receiver's Intermediary 2/Receiver's Intermediary 1/Receiving Custodian/ Buyer

These fields are filled as received in the MT541 SWIFT message.

Optional Repetitive Subsequence E2 Cash Parties

This sequence is only filled if the settlement message is the result of auto-collateralisation.

Mandatory Repetitive Subsequence E3 Amount

— :19A: - Settled Amount

Actual cash amount settled. This amount can differ from the instructed settlement amount (19A: :SETT from MT541) due to any applicable matching tolerances or in case of a partial settlement.

RWP – Receive with Payment: To debit the amount from the account, although normally this instruction would credit the amount to the account, use a negative sign [N] in this field of the instruction (MT541).

PFRD: For a payment free of receive (Sequence C :36B::ESTT = 0) this field is unsigned.

PFRC: For a credit free of receive (Sequence C :36B::ESTT = 0) this field has to be provided with a negative sign.

— :19A: - Other Amount

This field may contain default interest charged.

1.4.2.2.3 MT545 Examples

Transaction Type Cross-CSD Settlement

- Settlement confirmation for the MT541 example with customer reference "00004". A OeKB CSD customer and a CBF customer trade an AT ISIN versus payment. Both central securities depositories are counterparties within T2S.
- The instruction was submitted by the OeKB CSD customer with securities account number OCSD224200.
- The counterparty is the CBF customer with BIC DEUTDEFFXXX. In this transaction Deutsche Bank acts on behalf of its customer, Schnigge Wertpapierhandelsbank.
- The instruction was settled on the intended settlement date.

```

:16R:GENL
:20C::SEME//CSDA000005
:23G:NEWM
:98C::PREP//20131030020908
:16R:LINK
:20C::RELA//00004
:16S:LINK
:16R:LINK
:20C::MITI//T2SREF005
:16S:LINK
:16S:GENL
:16R:TRADEDET
:98A::TRAD//20131025
:98C::ESET//20131030020807
:98A::SETT//20131030
:35B:ISIN AT000BSP0004
:16S:TRADEDET
:16R:FIAC
:36B::ESTT//UNIT/3000,
:97A::SAFE//OCSD224200
:16S:FIAC
:16R:SETDET
:22F::SETR//TRAD
:16R:SETPRTY
:95P::PSET//DAKVDEFFXXX
:16S:SETPRTY
:16R:SETPRTY
:95P::DEAG//DEUTDEFFXXX
:20C::PROC//CPTYCUSTREF12345
:16S:SETPRTY
:16R:SETPRTY
:95Q::SELL//Schnigge
:16S:SETPRTY

```

:16R:AMT
:19A::ESTT//EUR26023,10
:16S:AMT
:16S:SETDET

Transaction Type Intra-CSD Settlement with Partial Settlement

Second partial execution of MT541. The partial execution involves 1000 units. A partial execution of 400 units already exists, 600 units remain not settled.

:16R:GENL
:20C::SEME//CSDA00003
:23G:NEWM
:98C::PREP//20140701101530
:22F::PARS//PAIN
:16R:LINK
:20C::RELA//00003
:16S:LINK
:16R:LINK
:20C::MITI//T2SREF003
:16S:LINK
:16S:GENL
:16R:TRADDET
:98A::TRAD//20140630
:98C::ESET//20140701101011
:98A::SETT//20140701
:35B:ISIN AT0000720008
:16S:TRADDET
:16R:FIAC
:36B::ESTT//UNIT/1000,
:36B::PSTT//UNIT/400,
:36B::RSTT//UNIT/600,
:19A::PSTT//EUR2882,
:19A::RSTT//EUR4323,
:97A::SAFE//OCSD227600
:16S:FIAC
:16R:SETDET
:22F::STCO//PART
:22F::SETR//TRAD
:16R:SETPRTY
:95P::PSET//OCSDATWWXXX
:16S:SETPRTY
:16R:SETPRTY
:95P::DEAG//GUTBATWWXXX
:20C::PROC//CPTYCUSTREF12345

:16S:SETPRTY
:16R:AMT
:19A::ESTT//EUR7205,
:16S:AMT
:16S:SETDET

Transaction Type PFRC

Settlement confirmation - an OeKB CSD customer makes a payment to another OeKB CSD customer without receiving securities.

:16R:GENL
:20C::SEME//CSDA00004
:23G:NEWM
:98C::PREP//20140701112010
:16R:LINK
:20C::RELA//00004
:16S:LINK
:16R:LINK
:20C::MITI//T2SREF004
:16S:LINK
:16S:GENL
:16R:TRADEDET
:98A::TRAD//20140630
:98C::ESET//20140701110505
:98A::SETT//20140701
:35B:ISIN AT0000720008
:16S:TRADEDET
:16R:FIAC
:36B::ESTT//UNIT/0,
:97A::SAFE//OCSD227600
:16S:FIAC
:16R:SETDET
:22F::SETR//TRAD
:16R:SETPRTY
:95P::PSET//OCSDATWWXXX
:16S:SETPRTY
:16R:SETPRTY
:95P::DEAG//GUTBATWWXXX
:20C::PROC//CPTYCUSTREF12345
:16S:SETPRTY
:16R:AMT
:19A::ESTT//EUR2530,
:16S:AMT
:16S:SETDET

Transaction Type RWP (Receive with Payment)

Settlement confirmation - a OeKB CSD customer receives units and a cash amount. Negative sign for the amount.

:16R:GENL

:20C::SEME//CSDA00005

:23G:NEWM

:98C::PREP//20140701085012

:16R:LINK

:20C::RELA//00005

:16S:LINK

:16R:LINK

:20C::MITI//T2SREF005

:16S:LINK

:16S:GENL

:16R:TRADEDET

:98A::TRAD//20140630

:98C::ESET//20140701083000

:35B:ISIN ATOTEAKHOLZ8

:16S:TRADEDET

:16R:FIAC

:36B::ESTT//UNIT/5000,

:97A::SAFE//OCSD225200

:16S:FIAC

:16R:SETDET

:22F::SETR//TRAD

:16R:SETPRTY

:95P::PSET//OCSDATWWXXX

:16S:SETPRTY

:16R:SETPRTY

:95P::DEAG//TUBDEDDXXX

:20C::PROC//CPTYCUSTREF12345

:16S:SETPRTY

:16R:AMT

:19A::ESTT//NEUR4200,

:16S:AMT

:16S:SETDET

1.4.2.3 MT546 – Deliver Free Confirmation

MT546 is the settlement confirmation for MT542 free of payment delivery instructions (DFP).

1.4.2.3.1 Content

M/O	Tag	Field Name	Qualifier	Option	Format	Codes	Description
Mandatory Sequence A General Information							
M	:16R:	Start of Block			16c	GENL	
M	:20C:	Sender's Reference	SEME		:4!c//16x		Reference assigned by the sender to unambiguously identify the message
M	:23G:	Function of the Message			4!c	NEWM	New message
						CANC	Message requesting the cancellation of a previously sent message.
M	:98C:	Preparation Date/Time	PREP		:4!c//8!n6!n		Date and time at which message was prepared.
O	:22F:	Partial Settlement Indicator	PARS		:4!c/[8c]/4!c	PAIN	Confirmation is for partial settlement. Part of the instruction remains unsettled.
						PARC	Confirmation is for partial settlement. No additional settlement will take place.
Optional Repetitive Subsequence A1 Linkages							
M	:16R:	Start of Block			16c	LINK	
M	:20C:	Reference	RELA		:4!c//16x		Related Message Reference
			MITI			T2S Market Infrastructure Transaction Identification	
			COMM			Common Reference	
			POOL			Pool Reference	
			PREV			Reference of the linked message which was previously sent.	
			CORP			Corporate Action Reference	
M	:16S:	End of Block			16c	LINK	Processor Transaction Identification

M/O	Tag	Field Name	Qualifier	Option	Format	Codes	Description
End of Subsequence A1 Linkages							
M	:16S:	End of Block			16c	GENL	
End of Sequence A General Information							
Mandatory Sequence B Trade Details							
M	:16R:	Start of Block			16c	TRADDET	
O	:94H:	Place of Clearing	CLEA		:4!c//4!a2!a2!c[3!c]		
O	:94B:	Place of Trade	TRAD		:4!c//4!c[/30x]	EXCH OTCO PRIM SECM VARI	Place of trade is a stock exchange Place of trade is over the counter. Place of trade is the primary market. Place of trade is the secondary market. Trade was executed on various places.
O	:98a:	Trade Date/Time	TRAD	A	:4!c//8!n		Date at which the trade was executed.
				C	:4!c//8!n6!n		Date and time at which the trade was executed.
M	:98C:	Effective Settlement Date/Time	ESET		:4!c//8!n6!n		Date and time at which a transaction effectively settled.
O	:98A:	Settlement Date	SETT		:4!c//8!n		Date at which the financial instruments are to be delivered or received.
M	:35B:	Identification of the Financial Instrument			ISIN1!e12!c		"ISIN" followed by <Blank> and ISIN Code
O	:22F:	Priority Indicator	PRIR		:4!c//4!c	0001	Priority set by CSD or NCBS

M/O	Tag	Field Name	Qualifier	Option	Format	Codes	Description
						0002	Top priority (can only be assigned to trading platforms (MTFs, stock exchanges, etc.)
						0003	High priority
						0004	Normal priority
O	:22F:	Trade Transaction Condition Indicator	TTCO		:4!c//4!c	CCPN XCPN	Trade was executed cum bonus. Trade was executed ex coupon.
O	:70E:	Narrative	SPRO		:4!c//10*35x		Provides additional settlement processing information which cannot be included within the structured fields of the message.
M	:16S:	End of Block			16c	TRADD ET	

End of Sequence B Trade Details

Mandatory Sequence C Financial Instrument/Account

M	:16R:	Start of Block			16c	FIAC	
M	:36B:	Quantity of Financial Instrument Settled	ESTT		:4!c//4!c/15d	FAMT UNIT	Face amount Unit number
O	:36B:	Quantity of Financial Instrument Previously Settled	PSTT		:4!c//4!c/15d	FAMT UNIT	Face amount Unit number
O	:36B:	Quantity of Financial Instrument remaining to be settled.	RSTT		:4!c//4!c/15d	FAMT UNIT	Face amount Unit number

M/O	Tag	Field Name	Qualifier	Option	Format	Codes	Description
M	:97A:	Safekeeping Account	SAFE		:4!c//35x		OeKB CSD's securities account number of the customer
M	:16S:	End of Block			16c	FIAC	

End of Sequence C Financial Instrument/Account

Mandatory Sequence E Settlement Details

M	:16R:	Start of Block			16c	SETDET	
M	:22F:	Type of Settlement Transaction	SETR		:4!c/[8!c]/4!c	CLAI	Transaction resulting from a market claim.
						COLI	Relates to a collateral transaction, from the point of view of the collateral taker or its agent.
						COLO	Relates to a collateral transaction, from the point of view of the collateral giver or its agent.
						TRAD	Type of Settlement Transaction Indicator
O	:22F:	Settlement Transaction Condition Indicator	STCO		:4!c/[8c]/4!c	NPAR	Partial settlement is not allowed.
						PART	Partial settlement is allowed.
						NOMC	No market claim should be automatically generated.

M/O	Tag	Field Name	Qualifier	Option	Format	Codes	Description
						TRAN	Transaction resulting from a transformation.
					:4!c/COEX/4!c	PARQ	Partial Settlement is Allowed with Minimum Quantity
						PARC	Partial Settlement is Allowed with Minimum Cash Value
					:4!c/REGL/4!c	BSSP	Instruction Resulting from Partially Successful Buy-In
O	:22F:	Securities Sub-balance Type Indicator	SSBT		:4!c/[8c]/4!c	BLOn	Blocking
						RESn	Reservation
						EEUR	Earmarking for autocoll.
						EARn	Other earmarking
O	:22F:	Beneficial Ownership Indicator	BENE		:4!c/[8c]/4!c	NBEN	No Change of Beneficial Ownership (NCBO)
						YBEN	Change of Beneficial Ownership (CBO)

Mandatory Repetitive Subsequence E1 Settlement Parties

M	:16R:	Start of Block			16c	SETPRT Y	
M	:95P:	Place of Settlement	PSET		:4!c//4!a2!a2!c[3!c]		Place of settlement (depository)
M	:16S:	End of Block			16c	SETPRT Y	
M	:16R:	Start of Block			16c	SETPRT Y	
M	:95P:	Receiving Agent	REAG		:4!c//4!a2!a2!c[3!c]		Receiving party that interacts with the place of settlement
(M)	:97A:	Safekeeping Account	SAFE		4!c//35x		Counterparty's securities acc. number

M/O	Tag	Field Name	Qualifier	Option	Format	Codes	Description
O	:20C:	Processing Reference	PROC		:4!c//16x		Counterparty's customer reference (not present for External Instructions)
M	:16S:	End of Block			16c	SETPRT Y	
O	:16R:	Start of Block			16c	SETPRT Y	
O	:95a:	Receiver's Intermediary 2	REI2	P	:4!c//4!a2!a2!c[3!c]		Party that interacts with the receiver's intermediary 1
				R	:4!c/8!c/34x		
				Q	:4!c//4*35x		
O	:16S:	End of Block			16c	SETPRT Y	
O	:16R:	Start of Block			16c	SETPRT Y	
O	:95a:	Receiver's Intermediary 1	REI1	P	:4!c//4!a2!a2!c[3!c]		Party that interacts with the receiving agent
				R	:4!c/8!c/34x		
				Q	:4!c//4*35x		
O	:16S:	End of Block			16c	SETPRT Y	
O	:16R:	Start of Block			16c	SETPRT Y	
O	:95a:	Receiver's Custodian	RECU	P	:4!c//4!a2!a2!c[3!c]		Party that interacts with the receiving agent unless intermediaries exist
				R	:4!c/8!c/34x		
				Q	:4!c//4*35x		
O	:16S:	End of Block			16c	SETPRT Y	
O	:16R:	Start of Block			16c	SETPRT Y	

M/O	Tag	Field Name	Qualifier	Option	Format	Codes	Description
O	:95a:	Buyer	BUYR	P	:4!c//4!a2!a2!c[3!c]		Party that receives the financial instrument
				R	:4!c/8!c/34x		
				Q	:4!c//4*35x		
O	:16S:	End of Block			16c	SETPRT Y	
O	:16R:	Start of Block			16c	SETPRT Y	
O	:95P:	Delivering Agent	DEAG		:4!c//4!a2!a2!c[3!c]	SETPRT Y	Delivering party that interacts with the place of settlement.
O	:16S:	End of Block			16c	SETPRT Y	
O	:16R:	Start of Block			16c	SETPRT Y	
O	:95a:	Deliverer's Intermediary 2	DEI2	P	:4!c//4!a2!a2!c[3!c]		Party that interacts with the deliverer's intermediary 1
				R	:4!c/8!c/34x		
				Q	:4!c//4*35x		
O	:16S:	End of Block			16c	SETPRT Y	
O	:16R:	Start of Block			16c	SETPRT Y	
O	:95a:	Deliverer's Intermediary 1	DEI1	P	:4!c//4!a2!a2!c[3!c]		Party that interacts with the delivering agent
				R	:4!c/8!c/34x		
				Q	:4!c//4*35x		
O	:16S:	End of Block			16c	SETPRT Y	
O	:16R:	Start of Block			16c	SETPRT Y	
O	:95a:	Deliverer's	DECU	P	:4!c//4!a2!a2!c[3!c]		

M/O	Tag	Field Name	Qualifier	Option	Format	Codes	Description
		Custodian		R	:4!c/8!c/34x		Party that interacts with the delivering agent unless intermediaries exist
				Q	:4!c//4*35x		
O	:16S:	End of Block			16c	SETPRT Y	
O	:16R:	Start of Block			16c	SETPRT Y	
O	:95a:	Seller	SELL	P	:4!c//4!a2!a2!c[3!c]		Party that delivers the financial instrument
				R	:4!c/8!c/34x		
				Q	:4!c//4*35x		
M	:16S:	End of Block			16c	SETPRT Y	
End of Subsequence E1 Settlement Parties							
M	:16S:	End of Block			16c	SETDET	
End of Sequence E Settlement Details							

1.4.2.3.2 Explanation of the SWIFT Fields

Sequence A – General Information

— :22F: - Partial Settlement Indicator

PAIN: This indicator is sent with messages where only partial settlement of the instruction was possible.

PARC: This indicator is sent with the last message to confirm that the last remaining part was settled.

Optional Repetitive Subsequence A1 Linkages

— :20C: - Reference

RELA: This field contains the customer reference of the MT543 SWIFT message that was sent.

MITI: Unique transaction reference of T2S.

COMM: Unique reference agreed between the two counterparties.

POOL: Reference identifying a group of messages.

PREV: This field contains the message reference of the message which was previously sent.

CORP: Reference assigned by the OeKB CSD to identify a relevant corporate action.

PCTI: This field contains the customer reference, if the instructing party differs from the account owner party. In this case the field RELA contains "NONREF". Exception: transaction type Physical (Issuer Services Reference), multicurrency instructions, transaction type External-CSD.

Mandatory Sequence B Trade Details

— :98C: - Effective Settlement Date/Time

Date and time³ of the effective settlement date.

— :35B: - Identification of the Financial Instrument

This field only contains the ISIN. The security name is no longer specified.

— :22F: - Priority Indicator

PRIR: The priority, by which a transaction (an instruction pair) is settled, is determined by the instruction with the higher priority. For settlement instructions it is possible to choose from 2 priority levels: High Priority (0003) and Normal Priority (0004). Priority level 0001 (Reserved) is reserved for CSDs and central banks. Priority level 0002 (Top Priority) is reserved for stock exchanges, MTFs, and CCPs.

Mandatory Sequence C Financial Instrument/Account

— :36B: - Quantity of Financial Instrument Settled

ESTT: The actual quantity of securities settled. In case of partial settlement the settled part is indicated.

— :36B: - Quantity of Financial Instrument Previously Settled

PSTT: In case of partial settlement the part that was already settled.

— :36B: - Quantity of Financial Instrument Remaining to be Settled

RSTT: In case of partial settlement the part that was not yet settled

Mandatory Sequence E Settlement Details

— :22F: Type of Settlement Transaction

CLAI: Used for an instruction resulting from a market claim.

COLI: Used for a collateral instruction (credit provider).

COLO: Used for a collateral instruction (credit consumer).

TRAD: Used for a standard settlement instruction.

AUTO: Instruction was generated automatically in the course of auto-collateralisation.

CORP: Instruction was generated automatically in the course of a corporate action.

— :22F: Settlement Transaction Condition Indicator

³ The current time is provided, which also applies to confirmations in NTS (until midnight) - the settlement date is already the date of the next day!

NPAR: Partial settlement of an instruction is not allowed.

PART: Partial settlement of an instruction is allowed.

PARQ: Partial Settlement is allowed with Minimum Quantity

PARC: Partial Settlement is allowed with Minimum Cash Value

NOMC: Opt-out indicator.

BSSP: Instruction Resulting from Partially Successful Buy-In. If the matching instruction is also instructed with this Settlement Transaction Condition both instructions will be exempt from Late Matching penalty fees. It is not a matching field.

This field is filled as received in the MT542 or MT530 SWIFT message.

For details, please see *Annex 8 Guideline Settlement and Securities Account Administration*.

— :22F: - Securities Sub-balance Type Indicator

SSBT: For this qualifier the use of Data Source Scheme "RT" (:4!c/RT/4!c) is compulsory.

For codes BLOn, RESn and EARn the rule "1<=n<=9", e.g. BLO1, BLO2,...., BLO9 applies

This field is filled as received in the MT542 SWIFT message.

1.4.2.3.3 MT546 Examples

Transaction Type Intra-CSD without Partial Settlement

Settlement confirmation of a free of payment delivery of units from OeKB CSD customer OCSD227600 to an OeKB CSD customer.

:16R:GENL

:20C::SEME//00111

:23G:NEWM

:98C::PREP//20140701051002

:16R:LINK

:20C::RELA//00011

:16S:LINK

:16R:LINK

:20C::MITI//T2SREF0033

:16S:LINK

:16S:GENL

:16R:TRADDET

:98A::TRAD//20140630

:98C::ESET//20140701050500

:98A::SETT//20140701

:35B:ISIN AT0000720008

:16S:TRADDET
:16R:FIAC
:36B::ESTT//UNIT/1000,
:97A::SAFE//OCSD227600
:16S:FIAC
:16R:SETDET
:22F::SETR//TRAD
:22F::STCO//NPAR
:16R:SETPRTY
:95P::PSET//OCSDATWWXXX
:16S:SETPRTY
:16R:SETPRTY
:95P::REAG//DEUTDEFFXXX
:20C::PROC//CPTYCUSTREF12345
:16S:SETPRTY
:16R:SETPRTY
:95P::BUYR//MGTCBEBEXXX
:16S:SETPRTY
:16S:SETDET

Transaction Type Cross-CSD Settlement

Settlement confirmation of a free of payment delivery from OeKB CSD customer OCSD227600 to a Clearstream customer. Settlement date 01.07.2014, settled on 03.07.2014.

:16R:GENL
:20C::SEME//000222
:23G:NEWM
:98C::PREP//20140703113000
:16R:LINK
:20C::RELA//00022
:16S:LINK
:16R:LINK
:20C::MITI//T2SREF0044
:16S:LINK
:16S:GENL
:16R:TRADDET
:98A::TRAD//20140630
:98C::ESET//20140703112502
:98A::SETT//20140701
:35B:ISIN XS0212688013
:16S:TRADDET
:16R:FIAC
:36B::ESTT//FAMT/10000,
:97A::SAFE//OCSD227600

:16S:FIAC
:16R:SETDET
:22F::SETR//TRAD
:16R:SETPRTY
:95P::PSET//DAKVDEFFXXX
:16S:SETPRTY
:16R:SETPRTY
:95P::REAG//DEUTDEFFXXX
:20C::PROC//CPTYCUSTREF12345
:16S:SETPRTY
:16R:SETPRTY
:95Q::BUYR//Deutsche Bank Muenchen
:16S:SETPRTY
:16S:SETDET

1.4.2.4 MT547 – Deliver Against Payment Confirmation

MT547 is the settlement confirmation for delivery instructions versus payment (DVP), for delivery with payment (DWP), for payments free of delivery (PFDD) and for credits free of delivery (PFDC). Since External instructions can only be Free of Payment there can be no MT547 for External Instructions.

Multicurrency settlement instructions: only DVP.

1.4.2.4.1 Content

M/O	Tag	Field Name	Qualifier	Option	Format	Codes	Description
Mandatory Sequence A General Information							
M	:16R:	Start of Block			16c	GENL	
M	:20C:	Sender's Reference	SEME		:4!c//16x		Reference assigned by the sender to unambiguously identify the message
M	:23G:	Function of the Message			4!c	NEWM CANC	New message Message requesting the cancellation of a previously sent message.
M	:98C:	Preparation Date/Time	PREP		:4!c//8!n6!n		Date and time at which message was prepared.
O	:22F:	Partial Settlement Indicator	PARS		:4!c/[8c]/4!c	PAIN	Confirmation is for partial settlement. Part of the instruction remains unsettled.

M/O	Tag	Field Name	Qualifier	Option	Format	Codes	Description
						PARC	Confirmation is for partial settlement. No additional settlement will take place.

Optional Repetitive Subsequence A1 Linkages

M	:16R:	Start of Block			16c	LINK	
M	:20C:	Reference	RELA		:4!c//16x		Related Message Reference
			MITI				T2S Market Infrastructure Transaction Identification
			COMM				Common Reference
			POOL				Pool Reference
			PREV				Reference of the linked message which was previously sent.
			CORP				Corporate Action Reference
			PCTI				Processor Transaction Identification
M	:16S:	End of Block			16c	LINK	

End of Subsequence A1 Linkages

M	:16S:	End of Block			16c	GENL	
---	-------	--------------	--	--	-----	------	--

End of Sequence A General Information

Mandatory Sequence B Trade Details

M	:16R:	Start of Block			16c	TRADDET	
O	:94H:	Place of Clearing	CLEA		:4!c//4!a2!a2!c[3!c]		
O	:94B:	Place of Trade	TRAD		:4!c//4!c[/30x]	EXCH	Place of trade is a stock exchange
						OTCO	Place of trade is over the counter.
						PRIM	Place of trade is the primary market.
						SECM	Place of trade is the secondary market.

M/O	Tag	Field Name	Qualifier	Option	Format	Codes	Description
						VARI	Trade was executed on various places.
M	:98A:	Trade Date/Time	TRAD	A	:4!c//8!n		Date at which the trade was executed.
				C	:4!c//8!n6!n		Date and time at which the trade was executed.
M	:98C:	Effective Settlement Date/Time	ESET		:4!c//8!n6!n		Date and time at which a transaction effectively settled.
O	:98A:	Settlement Date	SETT		:4!c//8!n		Date at which the financial instruments are to be delivered or received.
M	:35B:	Identification of the Financial Instrument			ISIN1!e12!c		"ISIN" followed by <Blank> and ISIN Code
O	:22F:	Priority Indicator	PRIR		:4!c//4!c	0001	Priority set by CSD or NCBS
						0002	Top priority (can only be assigned to trading platforms (MTFs, stock exchanges, etc.)
						0003	High priority
						0004	Normal priority
O	:22F:	Trade Transaction Condition Indicator	TTCO		:4!c//4!c	CCPN	Trade was executed cum bonus.
						XCPN	Trade was executed ex coupon.
O	:70E:	Narrative	SPRO		:4!c//10*35x		Provides additional settlement processing information which cannot be included within the structured fields of the message.
M	:16S:	End of Block			16c	TRADDET	
End of Sequence B Trade Details							
Mandatory Sequence C Financial Instrument/Account							
M	:16R:	Start of Block			16c	FIAC	

M/O	Tag	Field Name	Qualifier	Option	Format	Codes	Description
M	:36B :	Quantity of Financial Instrument Settled	ESTT		:4!c//4!c/15d	FAMT	Face amount
						UNIT	Unit number
O	:36B :	Quantity of Financial Instrument Previously Settled	PSTT		:4!c//4!c/15d	FAMT	Face amount
						UNIT	Unit number
O	:36B :	Quantity of Financial Instrument remaining to be settled.	RSTT		:4!c//4!c/15d	FAMT	Face amount
						UNIT	Unit number
O	:19A:	Previously Settled Amount	PSTT		:4!c//[N]3!a15d		
O	:19A:	Remaining Settlement Amount	RSTT		:4!c//[N]3!a15d		
M	:97A:	Safekeeping Account	SAFE		:4!c//35x		OeKB CSD's securities account number of the customer
O	:97A:	Cash Account	CASH		:4!c//35x		Account in which cash is maintained
M	:16S:	End of Block			16c	FIAC	

End of Sequence C Financial Instrument/Account

Mandatory Sequence E Settlement Details

M	:16R:	Start of Block			16c	SETDET	
M	:22F:	Type of Settlement Transaction	SETR		:4!c/[8!c]/4!c	CLAI	Transaction resulting from a market claim.
						COLI	Relates to a collateral transaction, from the point of view of the collateral taker or its agent.
						COLO	Relates to a collateral transaction, from the point of view of the collateral giver or its agent.

M/O	Tag	Field Name	Qualifier	Option	Format	Codes	Description
						TRAD	Type of Settlement Transaction Indicator
					:4!c/COEX/4!c	AUTO	Auto-collateralisation, in case of an Intra-day Restriction on the eligible ISIN
						CORP	Relates to a transaction generated as a result of a corporate action
O	:22F:	Settlement Transaction Condition Indicator	STCO		:4!c/[8c]/4!c	NPAR	Partial settlement is not allowed.
						PART	Partial settlement is allowed.
						NOMC	No market claim should be automatically generated.
						TRAN	Transaction resulting from a transformation.
					:4!c/COEX/4!c	PARQ	Partial Settlement is Allowed with Minimum Quantity
						PARC	Partial Settlement is Allowed with Minimum Cash Value
					:4!c/REGL/4!c	BSSP	Instruction Resulting from Partially Successful Buy-In
O	:22F:	Securities Sub-balance Type Indicator	SSBT		:4!c/[8c]/4!c	BLO n	Blocking
						RES n	Reservation
						EEUR	Earmarking for autocoll.
						EAR n	Other earmarking
O	:22F:	Beneficial Ownership Indicator	BENE		:4!c/[8c]/4!c	NBEN	No Change of Beneficial Ownership (NCBO)
						YBEN	Change of Beneficial Ownership (CBO)

M/O	Tag	Field Name	Qualifier	Option	Format	Codes	Description
Mandatory Repetitive Subsequence E1 Settlement Parties							
M	:16R:	Start of Block			16c	SETPRTY	
M	:95P:	Place of Settlement	PSET		:4!c//4!a2!a2!c[3!c]		Place of settlement (depository)
M	:16S:	End of Block			16c	SETPRTY	
M	:16R:	Start of Block			16c	SETPRTY	
M	:95P:	Receiving Agent	REAG		:4!c//4!a2!a2!c[3!c]		Receiving party that interacts with the place of settlement
(M)	:97A:	Safekeeping Account	SAFE		4!c//35x		Counterparty's securities acc. number
O	:20C:	Processing Reference	PROC		:4!c//16x		Counterparty's customer reference
M	:16S:	End of Block			16c	SETPRTY	
O	:16R:	Start of Block			16c	SETPRTY	
O	:95a:	Receiver's Intermediary 2	REI2	P	:4!c//4!a2!a2!c[3!c]		Party that interacts with the receiver's intermediary 1
				R	:4!c/8!c/34x		
				Q	:4!c//4*35x		
O	:16S:	End of Block			16c	SETPRTY	
O	:16R:	Start of Block			16c	SETPRTY	
O	:95a:	Receiver's Intermediary 1	REI1	P	:4!c//4!a2!a2!c[3!c]		Party that interacts with the receiving agent
				R	:4!c/8!c/34x		
				Q	:4!c//4*35x		
O	:16S:	End of Block			16c	SETPRTY	
O	:16R:	Start of Block			16c	SETPRTY	
O	:95a:	Receiver's Custodian	RECU	P	:4!c//4!a2!a2!c[3!c]		Party that interacts with the receiving agent unless intermediaries exist
				R	:4!c/8!c/34x		
				Q	:4!c//4*35x		
O	:16S:	End of Block			16c	SETPRTY	
O	:16R:	Start of Block			16c	SETPRTY	
O	:95a:	Buyer	BUYR	P	:4!c//4!a2!a2!c[3!c]		Party that receives the financial instrument
				R	:4!c/8!c/34x		
				Q	:4!c//4*35x		
O	:16S:	End of Block			16c	SETPRTY	

M/O	Tag	Field Name	Qualifier	Option	Format	Codes	Description
O	:16R:	Start of Block			16c	SETPRTY	
O	:95P:	Delivering Agent	DEAG		:4!c//4!a2!a2!c[3!c]	SETPRTY	Delivering party that interacts with the place of settlement.
O	:16S:	End of Block			16c	SETPRTY	
O	:16R:	Start of Block			16c	SETPRTY	
O	:95a:	Deliverer's Intermediary 2	DEI2	P	:4!c//4!a2!a2!c[3!c]		Party that interacts with the deliverer's intermediary 1
				R	:4!c/8!c/34x		
				Q	:4!c//4*35x		
O	:16S:	End of Block			16c	SETPRTY	
O	:16R:	Start of Block			16c	SETPRTY	
O	:95a:	Deliverer's Intermediary 1	DEI1	P	:4!c//4!a2!a2!c[3!c]		Party that interacts with the delivering agent
				R	:4!c/8!c/34x		
				Q	:4!c//4*35x		
O	:16S:	End of Block			16c	SETPRTY	
O	:16R:	Start of Block			16c	SETPRTY	
O	:95a:	Deliverer's Custodian	DECU	P	:4!c//4!a2!a2!c[3!c]		Party that interacts with the delivering agent unless intermediaries exist
				R	:4!c/8!c/34x		
				Q	:4!c//4*35x		
O	:16S:	End of Block			16c	SETPRTY	
O	:16R:	Start of Block			16c	SETPRTY	
O	:95a:	Seller	SELL	P	:4!c//4!a2!a2!c[3!c]		Party that delivers the financial instrument
				R	:4!c/8!c/34x		
				Q	:4!c//4*35x		
M	:16S:	End of Block			16c	SETPRTY	

End of Subsequence E1 Settlement Parties

Optional Repetitive Subsequence E2 Cash Parties

M	:16R:	Start of Block			16c	CSHPRTY	
M	:95P:	Party	DEBT		:4!c//4!a2!a2!c[3!c]		BIC of debtor
M	:97A:	Account	CASH		:4!c//34x		Account in which cash is maintained.
M	:16S:	End of Block			16c	CSHPRTY	

M/O	Tag	Field Name	Qualifier	Option	Format	Codes	Description
End of Subsequence E2 Cash Parties							
Mandatory Repetitive Subsequence E3 Amount							
M	:16R:	Start of Block			16c	AMT	
M	:19A:	Settled Amount	ESTT		:4!c//[N]3!a15d		ISO-Currency code followed by cash amount
M	:16S:	End of Block			16c	AMT	
O	:16R:	Start of Block			16c	AMT	
O	:19A:	Other Amount	OTHR		:4!c//[N]3!a15d		ISO-Currency code followed by amount of penalty interest on arrears
M	:16S:	End of Block			16c	AMT	
End of Subsequence E3 Amount							
M	:16S:	End of Block			16c	SETDET	
End of Sequence E Settlement Details							

1.4.2.4.2 Explanation of the SWIFT Fields

Sequence A – General Information

— :22F: - Partial Settlement Indicator

PAIN: This indicator is sent with messages where only partial settlement of the instruction was possible.

PARC: This indicator is sent with the last message to confirm that the last remaining part was settled.

Optional Repetitive Subsequence A1 Linkages

— :20C: - Reference

RELA: This field contains the customer reference of the MT543 SWIFT message that was sent.

MITI: Unique transaction reference of T2S.

COMM: Unique reference agreed between the two counterparties.

POOL: Reference identifying a group of messages.

PREV: This field contains the message reference of the message which was previously sent.

CORP: Reference assigned by the OeKB CSD to identify a relevant corporate action.

PCTI: This field contains the customer reference, if the instructing party differs from the account owner party. In this case the field RELA contains "NONREF". Exception: transaction type Physical (Issuer Services Reference), multicurrency instructions.

Mandatory Sequence B Trade Details

- :98C: - Effective Settlement Date/Time

Date and time⁴ of the effective settlement date.

- :35B: - Identification of the Financial Instrument

This field only contains the ISIN. The security name is no longer specified.

- :22F: - Priority Indicator

PRIR: The priority, by which a transaction (an instruction pair) is settled, is determined by the instruction with the higher priority. For settlement instructions it is possible to choose from 2 priority levels: High Priority (0003) and Normal Priority (0004). Priority level 0001 (Reserved) is reserved for CSDs and central banks. Priority level 0002 (Top Priority) is reserved for stock exchanges, MTFs, and CCPs.

Mandatory Sequence C Financial Instrument/Account

- :36B: - Quantity of Financial Instrument Settled

ESTT: The actual quantity of securities settled. In case of partial settlement the settled part is indicated.

- :36B: - Quantity of Financial Instrument Previously Settled

PSTT: In case of partial settlement the part that was already settled.

- :36B: - Quantity of Financial Instrument Remaining to be Settled

RSTT: In case of partial settlement the part that was not yet settled.

- :19A: - Previously Settled Amount

PSTT: In case of partial settlement the cash amount that was already settled.

- :19A: - Remaining Settlement Amount

RSTT: In case of partial settlement the cash amount that was not yet settled.

Mandatory Sequence E Settlement Details

- :22F: Type of Settlement Transaction

CLAI: Used for an instruction resulting from a market claim.

COLI: Used for a collateral instruction (credit provider).

COLO: Used for a collateral instruction (credit consumer).

TRAD: Used for a standard settlement instruction.

AUTO: Instruction was generated automatically in the course of auto-collateralisation.

CORP: Instruction was generated automatically in the course of a corporate action.

⁴ The current time is provided, which also applies to confirmations in NTS (until midnight) - the settlement date is already the date of the next day!

— :22F: Settlement Transaction Condition Indicator

NPAR: Partial settlement of an instruction is not allowed.

PART: Partial settlement of an instruction is allowed.

PARQ: Partial Settlement is allowed with Minimum Quantity

PARC: Partial Settlement is allowed with Minimum Cash Value

NOMC: Opt-out indicator.

BSSP: Instruction Resulting from Partially Successful Buy-In. If the matching instruction is also instructed with this Settlement Transaction Condition both instructions will be exempt from Late Matching penalty fees. It is not a matching field.

This field is filled as received in the MT543 or MT530 SWIFT message.

For details, please see *Annex 8 Guideline Settlement and Securities Account Administration*.

— :22F: - Securities Sub-balance Type Indicator

SSBT: For this qualifier the use of Data Source Scheme "RT" (:4!c/RT/4!c) is compulsory.

For codes BLOn, RESn and EARn the rule "1<=n<=9", e.g. BLO1, BLO2,....., BLO9 applies.

This field is filled as received in the MT543 SWIFT message.

Mandatory Repetitive Subsequence E1 Settlement Parties

— :95P: - Receiving Agent

This field is used to identify the counterparty using the BIC. It is filled as received in the MT543 SWIFT message.

— :95a: - Receiver's Intermediary 2/Receiver's Intermediary 1/Receiving Custodian/ Buyer

These fields are filled as received in the MT543 SWIFT message. Any securities accounts included in the MT543 are not copied to the MT547.

— :95a: - Delivering Agent/Deliverer's Intermediary 2/Deliverer's Intermediary 1/Deliverer's Custodian/ Seller

These fields are filled as received in the MT543 SWIFT message. Any securities accounts included in the MT543 are not copied to the MT547.

Optional Repetitive Subsequence E2 Cash Parties

This sequence is only filled if the settlement message is the result of auto-collateralisation.

Mandatory Repetitive Subsequence E3 Amount

— :19A: - Settled Amount

Actual cash amount settled. This amount can differ from the instructed settlement amount (19A: :SETT from MT543) due to any applicable matching tolerances or in case of a partial settlement.

DWP – Delivery with Payment: To debit the amount from the account, although normally this instruction would credit the amount to the account, use a negative sign [N] in this field of the instruction (MT543).

PFDD: For a payment without delivery (Sequence C :36B::ESTT = 0) this field has to be provided with a negative sign.

PFDCredit: For a payment without delivery (Sequence C :36B::ESTT = 0) this field has to be provided unsigned.

— :19A: - Other Amount

This field may contain default interest charged. Both, debits (in this case a negative amount must be specified) or credits are taken into consideration.

1.4.2.4.3 MT547 Examples

Transaction Type Intra-CSD Settlement

Settlement confirmation for the MT543 example with customer reference "100000". Two OeKB CSD customers trade an AT ISIN versus payment.

- The instruction was submitted by the OeKB CSD customer with securities account number OCSD236500.
- The counterparty is the OeKB CSD customer with BIC SCHOATWWXXX.
- The instruction was settled on the intended settlement date.

```
:16R:GENL
:20C::SEME//CSDA000001
:23G:NEWM
:98C::PREP//20131030011543
:16R:LINK
:20C::RELA//100000
:16S:LINK
:16R:LINK
:20C::MITI//T2SREF12345
:16S:LINK
:16S:GENL
:16R:TRADDET
:98A::TRAD//20131025
:98C::ESET//20131030011450
:98A::SETT//20131030
:35B:ISIN AT000BSP0000
:16S:TRADDET
:16R:FIAC
:36B::ESTT//UNIT/200,
:97A::SAFE//OCSD236500
```

:16S:FIAC
:16R:SETDET
:22F::SETR//TRAD
:16R:SETPRTY
:95P::PSET//OCSDATWWXXX
:16S:SETPRTY
:16R:SETPRTY
:95P::REAG//SCHOATWWXXX
:20C::PROC//CPTYCUSTREF12345
:16S:SETPRTY
:16R:AMT
:19A::ESTT//EUR2999,10
:16S:AMT
:16S:SETDET

Transaction Type Intra-CSD Settlement

Settlement confirmation for the MT543 example with customer reference EB00387621. Two OeKB CSD customers trade an AT ISIN versus payment.

- The instruction was submitted by the OeKB CSD customer with securities account number OCSD227300.
- The counterparty is the OeKB CSD customer with BIC OCSDATWWXXX.
- Because partial settlement is allowed and the available positions only permitted the settlement of a part of the instruction, the instruction is settled in part. The remaining partial amount is then settled in a second settlement attempt.
- The positions of sub-balance RES1 was used for delivery.

MT547 for the partial amount settled first:

:16R:GENL
:20C::SEME//CSDA000007
:23G:NEWM
:98C::PREP//20140809140745
:22F::PARS//PAIN
:16R:LINK
:20C::RELA//EB00387621
:16S:LINK
:16R:LINK
:20C::MITI//T1587
:16S:LINK
:16S:GENL
:16R:TRADEDET
:98A::TRAD//20140804
:98C::ESET//20140809140720
:98A::SETT//20140809
:35B:ISIN AT0000743059

:22F::PRIR//0003
:70E::SPRO//Additional text line 1
Additional text line 2
:16S:TRADEDET
:16R:FIAC
:36B::ESTT//UNIT/400,
:36B::RSTT//UNIT/600,
:19A::RSTT//EUR28800,
:97A::SAFE//227300
:97A::CASH//123456
:16S:FIAC
:16R:SETDET
:22F::SETR//TRAD
:22F::STCO//PART
:22F::SSBT//RT/RES1
:16R:SETPRTY
:95P::PSET//OCSDATWWXXX
:16S:SETPRTY
:16R:SETPRTY
:95P::REAG//BAWAATWWXXX
:20C::PROC//CPTYCUSTREF12345
:16S:SETPRTY
:16R:SETPRTY
:95R::REI2/BANKB/BANK C
:16S:SETPRTY
:16R:SETPRTY
:95R::REI1/BA/BANK B
:16S:SETPRTY
:16R:SETPRTY
:95R::RECU/AA/BANK A
:16S:SETPRTY
:16R:SETPRTY
:95Q::BUYR//BANK D
:16S:SETPRTY
:16R:SETPRTY
:95R::DEI2/BANKX/BANK Y
:16S:SETPRTY
:16R:SETPRTY
:95R::DEI1/XA/BANK X
:16S:SETPRTY
:16R:SETPRTY
:95R::DECU/WA/BANK W
:16S:SETPRTY
:16R:SETPRTY

:95Q::SELL//BANK Z
:16S:SETPRTY
:16R:AMT
:19A::ESTT//EUR19200,
:16S:AMT
:16S:SETDET

MT547 for the partial amount settled in the second settlement attempt:

:16R:GENL
:20C::SEME//CSDA000008
:23G:NEWM
:98C::PREP//20140809153525
:22F::PARS//PARC
:16R:LINK
:20C::RELA//EB00387621
:16S:LINK
:16R:LINK
:20C::MITI//T1587
:16S:LINK
:16S:GENL
:16R:TRADDET
:98A::TRAD//20140804
:98C::ESET//20140809153456
:98A::SETT//20140809
:35B:ISIN AT0000743059
:22F::PRIR//0003
:70E::SPRO//Additional text line 1
Additional text line 2
:16S:TRADDET
:16R:FIAC
:36B::ESTT//UNIT/600,
:36B::PSTT//UNIT/400,
:19A::PSTT//EUR19200,
:97A::SAFE//227300
:97A::CASH//123456
:16S:FIAC
:16R:SETDET
:22F::SETR//TRAD
:22F::STCO//PART
:22F::SSBT//RT/RES1
:16R:SETPRTY
:95P::PSET//OCSDATWWXXX
:16S:SETPRTY

:16R:SETPRTY
:95P::REAG//BAWAATWWXXX
:20C::PROC//CPTYCUSTREF12345
:16S:SETPRTY
:16R:SETPRTY
:95R::REI2/BANKB/BANK C
:16S:SETPRTY
:16R:SETPRTY
:95R::REI1/BA/BANK B
:16S:SETPRTY
:16R:SETPRTY
:95R::RECU/AA/BANK A
:16S:SETPRTY
:16R:SETPRTY
:95Q::BUYR//BANK D
:16S:SETPRTY
:16R:SETPRTY
:95R::DEI2/BANKX/BANK Y
:16S:SETPRTY
:16R:SETPRTY
:95R::DEI1/XA/BANK X
:16S:SETPRTY
:16R:SETPRTY
:95R::DECU/WA/BANK W
:16S:SETPRTY
:16R:SETPRTY
:95Q::SELL//BANK Z
:16S:SETPRTY
:16R:AMT
:19A::ESTT//EUR28800,
:16S:AMT
:16S:SETDET

1.4.3 Settlement Status and Processing Advice – MT548

- Status message for a settlement instruction
- Status message for a modification instruction
- Status message for a cancellation order
- Status message for a settlement restriction
- Information about auto-collateralisation

The status message contains no details on the underlying instruction.

1.4.3.1 MT548 - Status Messages for Settlement Instructions

MT548 is used for responses to settlement instructions.

1.4.3.1.1 Content

M/O	Tag	Field Name	Qualifier	Option	Format	Codes	Description
Mandatory Sequence A General Information							
M	:16R:	Start of Block			16c	GENL	
M	:20C:	Sender's Reference	SEME		:4!c//16x		Sender's Message Reference
M	:23G:	Function of the Message			4!c	INST	Message reporting on an instruction status.
M	:98C:	Preparation Date/Time	PREP		:4!c//8!n6!n		Date and time at which message was prepared.
Mandatory Repetitive Subsequence A1 Linkages							
M	:16R:	Start of Block			16c	LINK	
M	:20C:	Reference	RELA		:4!c//16x		Reference of the linked message which was previously received.
			PREV				Reference of the linked message which was previously sent.
			MITI				T2S Market Infrastructure Transaction Identification
			CORP				Corporate Action Event ID bei Market Claims
			COMM				Unique reference agreed upon by the two trade counterparties to identify the trade.

M/O	Tag	Field Name	Qualifier	Option	Format	Codes	Description
			PCTI				Processor Transaction Identification
M	:16S:	End of Block			16c	LINK	
End of Subsequence A1 Linkages							
Mandatory Repetitive Subsequence A2 Status							
M	:16R:	Start of Block			16c	STAT	
M	:25D:	Instruction Processing Status	IPRC		:4!c//4!c		A detailed description of the status and reason codes used can be found under 1.4.3.2.1
		Matching Status	MTCH				
		Settlement Status	SETT				
Optional Repetitive Subsequence A2a Reason							
M	:16R:	Start of Block			16c	REAS	
M	:24B:	Cancellation Reason	CAND		:4!c/[8c]/4!c		A detailed description of the status and reason codes used can be found under 1.4.3.2.1
		Pending Reason	PEND				
		Pending/Failing Reason	PENF				
		Rejection Reason	REJT				
		Generated Reason	CGEN				
		Acknowledged Reason	PACK				
O	:70D:	Reason Narrative	REAS		:4!c//6*35x		Provides additional reason information.
M	:16S:	End of Block			16c	REAS	
End of Subsequence A2a Reason							
M	:16S:	End of Block			16c	STAT	
End of Subsequence A2 Status							
M	:16S:	End of Block			16c	GENL	
End of Sequence A General Information							
Optional Sequence B Settlement Transaction Details							
M	:16R:	Start of Block			16c	SETTRAN	

O	:94H:	Place of Clearing	CLEA	:4!c//4!a2!a2!c[3!c]		
O	:94B:	Place of Trade	TRAD	:4!c//4!c[/30x]	EXCH	Place of trade is a stock exchange
					OTCO	Place of trade is over the counter.
					PRIM	Place of trade is the primary market.
					SECM	Place of trade is the secondary market.
					VARI	Trade was executed on various places.
M	:35B:	Identification of the Financial Instrument		ISIN1!e12!c		"ISIN" followed by <Blank> and ISIN Code
M	:36B:	Quantity of Financial Instrument to be Settled	SETT	:4!c//4!c/15d	FAMT	Quantity expressed as an amount representing the face amount, that is, the principal, of a debt instrument.
					UNIT	Quantity expressed as a number, for example, a number of shares.
O	:36B:	Quantity of Financial Instrument Partially Released	SETT	:4!c//4!c/15d	FAMT	Quantity expressed as an amount representing the face amount, that is, the principal, of a debt instrument.
					UNIT	Quantity expressed as a number, for example, a number of shares.
O	:19A:	Settlement Amount	SETT	:4!c//[N]3!a15d		Total amount of money paid/to be paid or received in exchange of the financial instrument.
M	:97A:	Safekeeping Account	SAFE	:4!c//35x		OeKB CSD's securities account number of the customer
M	:22F:	Type of Settlement Transaction	SETR	:4!c/[8!c]/4!c	CLAI	Transaction resulting from a market claim.
					COLI	Relates to a collateral transaction, from the point of view of the collateral taker or its agent.
					COLO	Relates to a collateral transaction, from the point of view of the collateral giver or its agent.
					TRAD	Relates to the settlement of a trade.

					PREA	Transaction is a pre- advice, that is for matching purposes only.
					PAIR	Relates to cash penalties
				:4!c/COEX/4!c	AUTO	Auto-collateralisation, in case of an Intra-day Restriction on the eligible ISIN
					CORP	Relates to a transaction generated as a result of a corporate action
					REBL	Rebalancing
O	:22F:	Settlement Transaction Condition Indicator	STCO	:4!c/[8c]/4!c	NOMC	No market claim should be automatically generated.
					NPAR	Partial settlement is not allowed.
					TRAN	Transaction resulting from a transformation.
					PART	Partial settlement is allowed.
					PHYS	Securities are to be physically settled.
				:4!c/COEX/4!c	PARQ	Partial Settlement is Allowed with Minimum Quantity
					PARC	Partial Settlement is Allowed with Minimum Cash Value
				:4!c/REGL/4!c	BSSP	Instruction Resulting from Partially Successful Buy-In
M	:22H:	Receive/Deliver Indicator	REDE	:4!c/[8c]/4!c	DELI	Financial Instruments will be debited from the safekeeping account.
					RECE	Financial Instruments will be credited to the safekeeping account.
M	:22H:	Payment Indicator	PAYM	:4!c/[8c]/4!c	APMT	Against payment.
					FREE	Free of payment.
O	:98A:	Trade Date/Time	TRAD	A :4!c//8!n		Date at which the trade was executed.
				C :4!c//8!n6!n		Date and time at which the trade was executed.
O	:98C:	Acknowledged Status Timestamp	ASTS	:4!c//8!n6!n		The timestamp of acceptance or acknowledgement of the instruction by the account servicer.

O	:98C:	Matched Status Timestamp	MTCH		:4!c//8!n6!n		The timestamp of matching of the instruction by the account servicer.
M	:98A:	Settlement Date/Time	SETT	A	:4!c//8!n		Date at which the financial instruments are to be delivered or received
O	:22F:	Beneficial Ownership Indicator	BENE		:4!c/[8c]/4!c	NBEN YBEN	No Change of Beneficial Ownership (NCBO) Change of Beneficial Ownership (CBO)

Optional Repetitive Subsequence B1 Settlement Parties

M	:16R:	Start of Block			16c	SETPRTY	
M	:95P:	Place of Settlement	PSET		:4!c//4!a2!a2!c[3!c]		Place of settlement (depository)
M	:16S:	End of Block			16c	SETPRTY	
M	:16R:	Start of Block			16c	SETPRTY	
M	:95P:	Receiving Agent	REAG		:4!c//4!a2!a2!c[3!c]		Receiving party that interacts with the place of settlement
O	:97A:	Safekeeping Account	SAFE		4!c//35x		Counterparty's securities acc. number
O	:20C:	Processing Reference	PROC		:4!c//16x		Counterparty's customer reference (only present for matched non-External Delivery Instructions)
M	:16S:	End of Block			16c	SETPRTY	
O	:16R:	Start of Block			16c	SETPRTY	
O	:95a:	Receiver's Intermediary 2	REI2	P R Q	:4!c//4!a2!a2!c[3!c] :4!c/8!c/34x :4!c//4*35x		Party that interacts with the receiver's intermediary 1
O	:16S:	End of Block			16c	SETPRTY	
O	:16R:	Start of Block			16c	SETPRTY	
O	:95a:	Receiver's Intermediary 1	REI1	P R Q	:4!c//4!a2!a2!c[3!c] :4!c/8!c/34x :4!c//4*35x		Party that interacts with the receiving agent
O	:16S:	End of Block			16c	SETPRTY	
O	:16R:	Start of Block			16c	SETPRTY	
O	:95a:	Receiver's Custodian	RECU	P R Q	:4!c//4!a2!a2!c[3!c] :4!c/8!c/34x :4!c//4*35x		Party that interacts with the receiving agent unless intermediaries exist
O	:16S:	End of Block			16c	SETPRTY	
O	:16R:	Start of Block			16c	SETPRTY	
O	:95a:	Buyer	BUYR	P R	:4!c//4!a2!a2!c[3!c] :4!c/8!c/34x		Party that receives the financial instrument

				Q	:4!c//4*35x		
O	:16S:	End of Block			16c	SETPRTY	
O	:16R:	Start of Block			16c	SETPRTY	
O	:95P:	Delivering Agent	DEAG		:4!c//4!a2!a2!c[3!c]	SETPRTY	Delivering party that interacts with the place of settlement.
O	:20C:	Processing Reference	PROC		:4!c//16x		Counterparty's customer reference (only present for matched non-External Receive Instructions)
O	:16S:	End of Block			16c	SETPRTY	
O	:16R:	Start of Block			16c	SETPRTY	
O	:95a:	Deliverer's Intermediary 2	DEI2	P	:4!c//4!a2!a2!c[3!c]		Party that interacts with the deliverer's intermediary 1
				R	:4!c/8!c/34x		
				Q	:4!c//4*35x		
O	:16S:	End of Block			16c	SETPRTY	
O	:16R:	Start of Block			16c	SETPRTY	
O	:95a:	Deliverer's Intermediary 1	DEI1	P	:4!c//4!a2!a2!c[3!c]		Party that interacts with the delivering agent
				R	:4!c/8!c/34x		
				Q	:4!c//4*35x		
O	:16S:	End of Block			16c	SETPRTY	
O	:16R:	Start of Block			16c	SETPRTY	
O	:95a:	Deliverer's Custodian	DECU	P	:4!c//4!a2!a2!c[3!c]		Party that interacts with the delivering agent unless intermediaries exist
				R	:4!c/8!c/34x		
				Q	:4!c//4*35x		
O	:16S:	End of Block			16c	SETPRTY	
O	:16R:	Start of Block			16c	SETPRTY	
O	:95a:	Seller	SELL	P	:4!c//4!a2!a2!c[3!c]		Party that delivers the financial instrument
				R	:4!c/8!c/34x		
				Q	:4!c//4*35x		
M	:16S:	End of Block			16c	SETPRTY	
End of Subsequence B1 Settlement Parties							
M	:16S:	End of Block			16c	SETTRAN	
End of Sequence B Settlement Details							

1.4.3.1.2 Explanation of the SWIFT Fields

Sequence A – General Information

— :23G: - Function of the Message

INST: Response to a settlement instruction

Optional Repetitive Subsequence A1 Linkages

— :20C: - Reference

RELA: This field contains the customer reference of the MT541 to MT543 SWIFT message that was sent.

PREV: In case of Claims und Transformations this field contains the customer reference of the underlying instruction.

MITI: Unique transaction reference of T2S.

COMM: Unique reference agreed between the two counterparties.

PCTI: This field contains the customer reference, if the instructing party differs from the account owner party. In this case the field RELA contains "NONREF". Exception: transaction type Physical (Issuer Services Reference), multicurrency instructions, transaction type External-CSD.

Mandatory Repetitive Subsequence A2 Status

— :25D: Status

This field contains the status of the settlement instruction. Refer to 1.4.3.2.1 for a list of all codes used.

Optional Repetitive Subsequence A2a Reason

— :24B: - Reason

This field contains the reason code. Refer to 1.4.3.2.1 for a list of all codes used (PEND and PENF are not combinable).

Distinction PEND and PENF

PEND: PEND will be used when settlement of the instruction is still possible at ISD.

PENF: PENF will be used when settlement of the instruction is no longer possible at ISD (after relevant cut-offs for FOP and DVP).

— :70D: - Reason

If a part of a settlement instruction which is on party hold is released for settlement (partial release) this field contains the released quantity and quantity remaining on hold. The first 4 positions will represent a prefix PRQ/ followed by the settlement type (UNIT or FAMT) and by the digits of the "Partially released" quantity. After the last digit of the "partially released quantity", the next 4 positions will represent the settlement type (UNIT or FAMT) to separate both quantities followed by the digits of the "Quantity remaining on hold".

Optional Sequence B Settlement Transaction Details

— :35B: - Identification of the Financial Instrument

The ISIN is used to identify the security.

— :36B: - Quantity of Financial Instrument to be Settled/Partially Released

The quantity is specified as nominal value or as number of units.

— :19A: - Settlement Amount

If the instruction type is RVP, RWP or DVP, DWP, PFDC, PFDD, PFRC or PFRD the cash value of the instruction is specified.

— :97A: - Safekeeping Account

The securities account number of the OeKB CSD customer is specified here.

— :22F: - Type of Settlement Transaction

CLAI: The instruction referenced in the status message results from a market claim.

COLI: The underlying instruction of the status message is a collateral instruction.

COLO: The underlying instruction of the status message is a collateral instruction.

TRAD: The instruction referenced in the status message has the quality Instruct.

PREA: The instruction referenced in the status message has the quality Preadvice.

AUTO: Instruction was generated automatically in the course of auto-collateralisation.

CORP: Instruction was generated automatically in the course of a corporate action.

— :22F: - Settlement Transaction Condition Indicator

NMOC: No market claim shall be generated automatically.

NPAR: Partial settlement is not allowed.

PART: Partial settlement is allowed.

PARQ: Partial Settlement is allowed with Minimum Quantity

PARC: Partial Settlement is allowed with Minimum Cash Value

BSSP: Instruction Resulting from Partially Successful Buy-In. If the matching instruction is also instructed with this Settlement Transaction Condition both instructions will be exempt from Late Matching penalty fees. It is not a matching field.

— :22H: - Receive/Deliver Indicator

DELI: The instruction referenced in the status message is a delivery (SWIFT message MT542 or MT543).

RECE: The instruction referenced in the status message is a receipt (SWIFT message MT540 MT541).

— :22H: - Payment Indicator

APMT: The instruction referenced in the status message is versus payment (SWIFT message MT541 or MT543).

FREE: The instruction referenced in the status message is free of payment (SWIFT message MT540 or MT542).

— :98a: - Trade Date/Time

This field is filled as received in the SWIFT message sent or as entered on the Settlement Client.

— :98a: - Settlement Date/Time

This field is filled as received in the SWIFT message sent or as entered on the Settlement Client.

Optional Repetitive Subsequence B1 Settlement Parties

— :95P: - Place of Settlement

PSET: For identification the BIC of the counterparty (depository) is used as the sole reference.

— :95P: - Receiving Agent/Delivering Agent

Depending on the instruction type, either the field Receiving Agent (instruction type DVP, DWP and PFDC and PFDD) or the field Delivering Agent (instruction type RVP, RWP, PFRC and PFRD) is used to identify the counterparty.

— :95a: - Receiver's Intermediary 2/Receiver's Intermediary 1/Receiving Custodian/ Buyer

These fields are filled with the option as specified in the SWIFT message sent as instruction or as entered on the Settlement Client.

— :95a: - Deliverer's Intermediary 2/Deliverer's Intermediary 1/Deliverer's Custodian/ Seller

These fields are filled with the option as specified in the SWIFT message sent as instruction or as entered on the Settlement Client.

1.4.3.2 Differentiation of Instruction Types in MT548

With T2S there will be in addition to the existing instruction types (DVP, RVP, DFP und RFP) six additional types: DWP, RWP, PFDC, PFDD, PFRC and PFRD. In the MT548 message the instruction type cannot be provided explicitly. Instead it can be derived from the contents of the following fields in subsequence B1a2. The sign in :19A::SETT is set according to the sign of the corresponding MT instruction (MT541-MT543):

— :22H::REDE (Receive Deliver Indicator)

— :22H::PAYM (Payment Indicator)

— :19A::SETT (Amount)

— :36B::SETT (Quantity)

	:22H::REDE	:22H::PAYM	:19A::SETT	:36B::SETT
DVP	DELI	APMT	+	+
RVP	RECE	APMT	+	+
DFP	DELI	FREE	n.a	+
RFP	RECE	FREE	n.a.	+
DWP	DELI	APMT	-	+
RWP	RECE	APMT	-	+

	:22H::REDE	:22H::PAYM	:19A::SETT	:36B::SETT
PFDC	DELI	APMT	+	0
PFDD	DELI	APMT	-	0
PFRC	RECE	APMT	-	0
PFRD	RECE	APMT	+	0

1.4.3.2.1 Status and Reason Codes

The following list contains the status and reason codes in use.

Reason	:25D: Status	Code	:24B: Reason	Code	Description
Instruction cancelled due to customer order.	IPRC	CAND	CAND	CANI	Cancelled By Yourselves
Instruction cancelled by the system.	IPRC	CAND	CAND	CANS	Cancelled By System
Instruction cancelled due to a transformation.	IPRC	CAND	CAND	CANT	Cancellation due to Transformation
Instruction cancelled by a third party.	IPRC	CAND	CAND	CTHP	Cancelled By Third Party
Instruction cancelled due to Buy-In	IPRC	CAND	CAND	BYIY	Cancelled Due To Buy In
Instruction cancelled by agent	IPRC	CAND	CAND	CSUB	Cancelled by Agent
Instruction has expired	IPRC	CAND	CAND	EXPI	Expired
Original instruction has been cancelled and replaced to allow a partial or split settlement.	IPRC	CAND	CAND	CANZ	Cancelled due to Split Partial Settlement
Instruction cancelled due to corporate action	IPRC	CAND	CAND	CORP	Cancelled Due To Corporate Action
Instruction has been cancelled; the security no longer exists or is no longer eligible on the market instructed.	IPRC	CAND	CAND	SCEX	Securities No Longer Eligible
Reason indicated in free text field.	IPRC	CAND	CAND	NARR	Narrative Reason
Reason indicated in free text field.	IPRC	PACK	PACK	NARR	Narrative Reason
Counterparty cancellation request waiting for cancellation confirmation.	IPRC	CPRC			Cancellation Request
Instruction rejected due to unknown or invalid cash account.	IPRC	REJT	REJT	CASH	Cash Account Rejection

Reason	:25D: Status	Code	:24B: Reason	Code	Description
Instruction rejected due to invalid settlement date.	IPRC	REJT	REJT	DDAT	Settlement Date Rejection
Instruction rejected due to unknown or invalid place of settlement.	IPRC	REJT	REJT	DEPT	Place of Settlement Rejection
Instruction rejected due to invalid settlement amount.	IPRC	REJT	REJT	DMON	Settlement Amount Rejection
Instruction rejected due to unknown or invalid settlement quantity.	IPRC	REJT	REJT	DQUA	Quantity Rejection
Instruction rejected due to unknown or invalid ISIN.	IPRC	REJT	REJT	DSEC	Security Rejection
Instruction rejected due to unknown or invalid trade date.	IPRC	REJT	REJT	DTRD	Trade Date Rejection
Instruction rejected due to unknown REAG or DEAG.	IPRC	REJT	REJT	ICAG	Agent Rejection
Instruction rejected due to invalid BIC or missing parties in the delivery chain.	IPRC	REJT	REJT	ICUS	Receiving or Delivering Custodian Rejection
Instruction rejected due to invalid or missing sub-balance type.	IPRC	REJT	REJT	INVB	Balance Rejection
Instruction rejected due to unknown, invalid or missing link.	IPRC	REJT	REJT	INVL	Link Rejection
Instruction rejected due to unknown, invalid or missing lot number.	IPRC	REJT	REJT	INVN	Number Rejection
Instruction rejected, as minimum instruction quantity was not observed.	IPRC	REJT	REJT	MINO	Minimum Settlement Quantity
Instruction rejected, as smallest denomination was not observed.	IPRC	REJT	REJT	MUNO	Multiple Settlement Quantity
Instruction rejected due to unknown or invalid settlement currency.	IPRC	REJT	REJT	NCRR	Settlement Amount Currency Rejection
Reason indicated in free text field.	IPRC	REJT	REJT	NARR	Narrative Reason
Instruction rejected, as instruction reference is identical with another recently received instruction.	IPRC	REJT	REJT	REFE	Reference Rejection

Reason	:25D: Status	Code	:24B: Reason	Code	Description
Instruction rejected, as securities account indicated does not exist or is not active.	IPRC	REJT	REJT	SAFE	Safekeeping Account Rejection
Instruction rejected, as sender of SWIFT message is not authorised for indicated securities account.					
Unknown or incorrect settlement transaction type (refers to the codes for the SETR qualifier available in sequence E field 22F).	IPRC	REJT	REJT	SETR	Settlement Transaction Rejection
Instruction rejected due to validation rules.	IPRC	REJT	REJT	VALR	Validation Rule Rejection
Instruction generated due to market claim	IPRC	CGEN	CGEN	CLAI	Instruction generated due to market claim
Instruction generated due to transformation	IPRC	CGEN	CGEN	TRAN	Instruction generated due to transformation
Instruction was matched.	MTCH	MACH			Matched
Information that securities account is blocked.	SETT	PEND PENF	PEND PENF	BLOC	Account Blocked
Instruction of counterparty and own instruction are set on Hold.	SETT	PEND PENF	PEND PENF	BOTH	Both Instructions on Hold (wird derzeit von T2S nicht verwendet)
Instruction on Hold and waiting for approval by administrating party.	SETT	PEND PENF	PEND PENF	CDLR	Conditional Delivery Awaiting Release
Securities account of counterparty contains insufficient coverage.	SETT	PEND PENF	PEND PENF	CLAC	Counterparty Insufficient Securities ⁵
Cash account of counterparty contains insufficient cash coverage.	SETT	PEND PENF	PEND PENF	CMON	Counterparty Insufficient Money
The CSD has set the instruction on Hold.	SETT	PEND PENF	PEND PENF	CSDH	CSD Hold
Instruction is set on Hold if one of the restrictions set by the CSD applies.	SETT	PEND PENF	PEND PENF	CVAL	CSD Validation

⁵ For multicurrency settlement instructions CLAC will not be sent.

Reason	:25D: Status	Code	:24B: Reason	Code	Description
Information that instruction was approved and that there are no more Holds. Instruction is waiting for settlement date.	SETT	PEND	PEND	FUTU	Awaiting Settlement Date
Not all linked-to instructions of a pool have yet been received.	SETT	PEND PENF	PEND PENF	INBC	Incomplete Number Count
Securities account of customer contains insufficient coverage for delivery.	SETT	PEND PENF	PEND PENF	LACK	Lack of Securities
Instruction was submitted after market deadline.	SETT	PEND PENF	PEND PENF	LATE	Market Deadline Missed
Instruction status is "pending", as linked-to instruction status is "pending".	SETT	PEND PENF	PEND PENF	LINK	Pending Linked Instruction
Cash account of customer contains insufficient coverage.	SETT	PEND PENF	PEND PENF	MONY	Insufficient Money
Reason indicated in free text field.	SETT	PEND PENF	PEND PENF	NARR	Narrative Reason
Information that instruction was partially settled, but part remains to be settled.	SETT	PEND PENF	PEND PENF	PART	Trade settles in Partials
Counterparty instruction status is a Hold status.	SETT	PEND PENF	PEND PENF	PRCY	Counterparty Instruction on Hold
Instruction status is Party Hold (Preadvice).	SETT	PEND PENF	PEND PENF	PREA	Your Instruction on Hold Party Hold
Instruction has Partial Release.	SETT	PEND PENF	PEND PENF	PREL	Transaction has been partially released.
Instruction is set to CoSD Hold.	SETT	PEND PENF	PEND PENF	PRSY	On Hold by System
Information that securities position is blocked.	SETT	PEND PENF	PEND PENF	SBLO	Securities Blocked
Instruction is waiting for settlement.	SETT	PENF	PENF	CYCL	Awaiting Next Settlement Cycle

1.4.3.2.2 MT548 Examples

Partial Settlement

Information that the instruction was settled in part, but another part remains to be settled.

:16R:GENL
:20C::SEME//CSDA00007
:23G:INST
:98C::PREP//20150103103025
:16R:LINK
:20C::RELA//REFABCD
:16S:LINK
:16R:LINK
:20C::MITI//T1290
:16S:LINK
:16R:STAT
:25D::SETT//PEND
:16R:REAS
:24B::PEND//PART
:16S:REAS
:16S:STAT
:16S:GENL
:16R:SETTRAN
:35B:ISIN ISIN00000001
:36B::SETT//UNIT/40000,
:19A::SETT//EUR230000,
:97A::SAFE//1000000123
:22F::SETR//TRAD
:22H::REDE//DELI
:22H::PAYM//APMT
:98A::TRAD//20150102
:98C::ASTS//20150103110213
:98C::MTCH//20150103110215
:98A::SETT//20150103
:16R:SETPRTY
:95P::PSET//OCSDATW0XXX
:16S:SETPRTY
:16R:SETPRTY
:95P::REAG//BKAUATW0XXX
:20C::PROC//CPTYCUSTREF12345
:16S:SETPRTY
:16S:SETTRAN

Cancellation Requested

Counterparty cancellation request - counterparty has cancelled a matched instruction.

:16R:GENL
:20C::SEME//CSDA00007
:23G:INST
:98C::PREP//20150103103025
:16R:LINK
:20C::RELA//REFABCD
:16S:LINK
:16R:LINK
:20C::MITI//T1290
:16S:LINK
:16R:STAT
:25D::IPRC//CPRC
:16S:STAT
:16S:GENL
:16R:SETTRAN
:35B:ISIN ISIN00000001
:36B::SETT//UNIT/100000,
:19A::SETT//EUR57500,
:97A::SAFE//1000000123
:22F::SETR//TRAD
:22H::REDE//DELI
:22H::PAYM//APMT
:98A::TRAD//20150102
:98C::ASTS//20150103110213
:98C::MTCH//20150103110215
:98A::SETT//20150103
:16R:SETPRTY
:95P::PSET//OCSDATW0XXX
:16S:SETPRTY
:16R:SETPRTY
:95P::REAG//BKAUATW0XXX
:20C::PROC//CPTYCUSTREF12345
:16S:SETPRTY
:16S:SETTRAN

Lack of Securities

The securities account of the customer contains an insufficient quantity of units for delivery at ISD (befor cut-off for DVP).

:16R:GENL
:20C::SEME//CSDA00007

:23G:INST
:98C::PREP//20150103103025
:16R:LINK
:20C::RELA//REFABCD
:16S:LINK
:16R:LINK
:20C::MITI//T1290
:16S:LINK
:16R:STAT
:25D::SETT//PEND
:16R:REAS
:24B::PEND//LACK
:70D::REAS//SXAA021-Failure of the settlement attempt of the settlement restriction due to a lack of securities in your securities position
:16S:REAS
:16S:STAT
:16S:GENL
:16R:SETTRAN
:35B:ISIN ISIN000000001
:36B::SETT//UNIT/100000,
:19A::SETT//EUR57500,
:97A::SAFE//1000000123
:22F::SETR//TRAD
:22F::STCO//PART
:22H::REDE//DELI
:22H::PAYM//APMT
:98A::TRAD//20150102
:98C::ASTS//20150102111013
:98C::MTCH//20150103110215
:98A::SETT//20150103
:16R:SETPRTY
:95P::PSET//OCSDATW0XXX
:16S:SETPRTY
:16R:SETPRTY
:95P::REAG//BKAUATW0XXX
:20C::PROC//CPTYCUSTREF12345
:16S:SETPRTY
:16S:SETTRAN

Lack of securities

The securities account of the customer contains an insufficient quantity of units for delivery (after cut-off for DVP at ISD).

:16R:GENL
:20C::SEME//4300899576T2S
:23G:INST
:98C::PREP//20190730065226
:16R:LINK
:20C::RELA//OCSD12345
:16S:LINK
:16R:LINK
:20C::MITI//1907262981032T2S
:16S:LINK
:16R:STAT
:25D::SETT//PENF
:16R:REAS
:24B::PENF//LACK
**:70D::REAS//SXAA014 - Failure of the settlement
attempt of the settlement instruct
ion due to a lack of securities in
your securities position**
:16S:REAS
:16S:STAT
:16S:GENL
:16R:SETTRAN
:35B:ISIN ISIN00000001
:36B::SETT//UNIT/795000,
:19A::SETT//EUR3524501,
:97A::SAFE//OCSD111100
:22F::SETR//TRAD
:22F::STCO//NPAR
:22H::REDE//DELI
:22H::PAYM//APMT
:98A::TRAD//20190725
:98C::ASTS//20190729110213
:98C::MTCH//20190729120213
:98A::SETT//20190729
:16R:SETPRTY
:95P::PSET//OCSDATWWXXX
:16S:SETPRTY
:16R:SETPRTY
:95P::REAG//PARBDEFFXXX
:20C::PROC//CPTYCUSTREF12345
:16S:SETPRTY
:16S:SETTRAN

Account Blocked

Information that the securities account is blocked.

:16R:GENL

:20C::SEME//CSDA00007

:23G:INST

:98C::PREP//20150103103025

:16R:LINK

:20C::RELA//REFABCD

:16S:LINK

:16R:LINK

:20C::MITI//T1290

:16S:LINK

:16R:STAT

:25D::SETT//PEND

:16R:REAS

:24B::PEND//BLOC

**:70D::REAS//SXAA003-Settlement Instruction
is not settled because of an intra
day restriction on the securities account used.**

:16S:REAS

:16S:STAT

:16S:GENL

:16R:SETTRAN

:35B:ISIN ISIN00000001

:36B::SETT//UNIT/100000,

:19A::SETT//EUR57500,

:97A::SAFE//1000000123

:22F::SETR//TRAD

:22F::STCO//PART

:22H::REDE//DELI

:22H::PAYM//APMT

:98A::TRAD//20150102

:98C::ASTS//20150102110213

:98C::MTCH//20150102120213

:98A::SETT//20150103

:16R:SETPRTY

:95P::PSET//OCSDATW0XXX

:16S:SETPRTY

:16R:SETPRTY

:95P::REAG//BKAUATW0XXX

:20C::PROC//CPTYCUSTREF12345

:16S:SETPRTY

:16S:SETTRAN

Matched

The instruction was matched with the counterparty instruction.

:16R:GENL
:20C::SEME//CSDA00007
:23G:INST
:98C::PREP//20150103103025
:16R:LINK
:20C::RELA//REFABCD
:16S:LINK
:16R:LINK
:20C::MITI//T1290
:16S:LINK
:16R:STAT
:25D::MTCH//MACH
:16S:STAT
:16S:GENL
:16R:SETTRAN
:35B:ISIN ISIN00000001
:36B::SETT//UNIT/100000,
:19A::SETT//EUR57500,
:97A::SAFE//1000000123
:22F::SETR//TRAD
:22F::STCO//PART
:22H::REDE//DELI
:22H::PAYM//APMT
:98A::TRAD//20150102
:98C::ASTS//201500102161419
:98C::MTCH//20150103103023
:98A::SETT//20150103
:16R:SETPRTY
:95P::PSET//OCSDATW0XXX
:16S:SETPRTY
:16R:SETPRTY
:95P::REAG//BKAUATW0XXX
:20C::PROC//CPTYCUSTREF12345
:16S:SETPRTY
:16S:SETTRAN

Counterparty Instruction on Hold

The counterparty instruction status is a Hold status.

:16R:GENL
:20C::SEME//CSDA00007

:23G:INST
:98C::PREP//20150103103025
:16R:LINK
:20C::RELA//REFEFGH
:16S:LINK
:16R:LINK
:20C::MITI//T1490
:16S:LINK
:16R:STAT
:25D::SETT//PEND
:16R:REAS
:24B::PEND//PRCY
:16S:REAS
:16R:REAS
:24B::PEND//PREA
:16S:REAS
:16S:STAT
:16S:GENL
:16R:SETTRAN
:35B:ISIN ISIN00000001
:36B::SETT//UNIT/100000,
:19A::SETT//EUR57500,
:97A::SAFE//1000000225
:22F::SETR//TRAD
:22F::STCO//PART
:22H::REDE//RECE
:22H::PAYM//APMT
:98A::TRAD//20150102
:98C::ASTS//20150102110213
:98C::MTCH//20150103103020
:98A::SETT//20150103
:16R:SETPRTY
:95P::PSET//OCSDATW0XXX
:16S:SETPRTY
:16R:SETPRTY
:95P::DEAG//BKAUATW0XXX
:20C::PROC//CPTYCUSTREF12345
:16S:SETPRTY
:16S:SETTRAN

Partial Release Instruction

Information, that a part of a settlement instruction has been released for settlement.

:16R:GENL
:20C::SEME//OCSD347891
:23G:INST
:98C::PREP//20190930163215
:16R:LINK
:20C::RELA//OCSD12345
:16S:LINK
:16R:LINK
:20C::MITI//1909301425001645
:16S:LINK
:16R:STAT
:25D::SETT//PEND
:16R:REAS
:24B::PEND//FUTU
:70D::REAS//AwaitingSettlementDate - PRQ/UNIT1000
00000UNIT79000.00000
:16S:REAS
:16R:REAS
:24B::PEND//PREA
:70D::REAS//Party Hold
:16S:REAS
:16S:STAT
:16S:GENL
:16R:SETTRAN
:35B:ISIN AT00000AMAG3
:36B::SETT//UNIT/80000,
:97A::SAFE//OCSD111100
:22F::SETR//TRAD
:22F::STCO//PART
:22H::REDE//DELI
:22H::PAYM//FREE
:98A::TRAD//20190930
:98C::ASTS//20190930110213
:98C::MTCH//20190930120723
:98A::SETT//20190930
:16R:SETPRTY
:95P::PSET//OCSDATWWXXX
:16S:SETPRTY
:16R:SETPRTY
:95P::REAG//RLNWATWWXXX
:20C::PROC//CPTYCUSTREF12345
:16S:SETPRTY
:16S:SETTRAN

Information, that a pending partial release instruction has been cancelled.

:16R:GENL
:20C::SEME//1198209591000
:23G:INST
:98C::PREP//20191001093216
:16R:LINK
:20C::RELA//HUAtest0110-1
:16S:LINK
:16R:LINK
:20C::MITI//1910011426544545
:16S:LINK
:16R:STAT
:25D::SETT//PEND
:16R:REAS
:24B::PEND//PREA
:70D::REAS//SPSA007 - Settlement instruction is
on hold because other holds apply
on the referenced Settlement Instru
ction or its counterpart
:16S:REAS
:16R:REAS
:24B::PEND//PREA
:70D::REAS//Party Hold
:16S:REAS
:16S:STAT
:16S:GENL
:16R:SETTRAN
:35B:ISIN AT00000AMAG3
:36B::SETT//UNIT/7000,
:97A::SAFE//OCSD111100
:22F::SETR//TRAD
:22F::STCO//PART
:22H::REDE//DELI
:22H::PAYM//FREE
:98A::TRAD//20191001
:98C::ASTS//20191001080213
:98C::MTCH//20191001080723
:98A::SETT//20191001
:16R:SETPRTY
:95P::PSET//OCSDATWWXXX
:16S:SETPRTY
:16R:SETPRTY
:95P::REAG//RLBBAT2EXXX
:20C::PROC//CPTYCUSTREF12345

:16R:GENL
 :16S:SETPRTY
 :16S:SETTRAN

Cash Penalties for Transaction Type Intra

PFDC - Payment Free of Delivery Credit

In this example the participant is entitled to receive penalties.

:16R:GENL
 :20C::SEME//1083123357000
 :23G:INST
 :98C::PREP//20200320105802
 :16R:LINK
 :20C::RELA//NONREF
 :16S:LINK
 :16R:LINK
 :20C::PCT//PFOD2003-1
 :16S:LINK
 :16R:LINK
 :20C::MITI//2003200312469987
 :16S:LINK
 :16R:STAT
 :25D::IPRC//PACK
 :16S:STAT
 :16R:STAT
 :25D::MTCH//NMAT
 :16S:STAT
 :16R:STAT
 :25D::SETT//PEND
 :16R:REAS
 :24B::PEND//FUTU
 :70D::REAS//AwaitingSettlementDate
 :16S:REAS
 :16S:STAT
 :16S:GENL
 :16R:SETTRAN
 :35B:ISIN LU2128008567
 :36B::SETT//UNIT/0,
 :19A::SETT//EUR2,27
 :97A::SAFE//OCSD115600
 :22F::SETR//PAIR
 :22F::STCO//NPAR
 :22H::REDE//DELI

:22H::PAYM//APMT
:98A::TRAD//20200320
:98C::ASTS//20200320105759
:98A::SETT//20200320
:16R:SETPRTY
:95P::PSET//OCSDATWWXXX
:16S:SETPRTY
:16R:SETPRTY
:95P::REAG//OCSDATWWXXX
:16S:SETPRTY
:16S:SETTRAN

PFDD - Payment Free of Delivery Debit

In this example the participant is imposed with penalties.

:16R:GENL
:20C::SEME//1083122991000
:23G:INST
:98C::PREP//20200320114547
:16R:LINK
:20C::RELA//NONREF
:16S:LINK
:16R:LINK
:20C::PCTI//PFOD2003-2
:16S:LINK
:16R:LINK
:20C::MITI//2003200312471570
:16S:LINK
:16R:STAT
:25D::IPRC//PACK
:16S:STAT
:16R:STAT
:25D::MTCH//NMAT
:16S:STAT
:16R:STAT
:25D::SETT//PEND
:16R:REAS
:24B::PEND//FUTU
:70D::REAS//AwaitingSettlementDate
:16S:REAS
:16S:STAT
:16S:GENL
:16R:SETTRAN

:35B:ISIN LU2128008567
:36B::SETT//UNIT/O,
:19A::SETT//NEUR31,03
:97A::SAFE//OCSD112100
:22F::SETR//PAIR
:22F::STCO//NPAR
:22H::REDE//DELI
:22H::PAYM//APMT
:98A::TRAD//20200320
:98C::ASTS//20200320114540
:98A::SETT//20200320
:16R:SETPRTY
:95P::PSET//OCSDATWWXXX
:16S:SETPRTY
:16R:SETPRTY
:95P::REAG//OCSDATWWXXX
:16S:SETPRTY
:16S:SETTRAN

Cash Penalties for Transaction Type External

PFDD - Payment Free of Delivery Debit

In this example the participant is imposed with penalties.

:16R:GENL
:20C::SEME//2083122991000
:23G:INST
:98C::PREP//20200320114547
:16R:LINK
:20C::RELA//NONREF
:16S:LINK
:16R:LINK
:20C::PCTI//PFOD2203-2
:16S:LINK
:16R:LINK
:20C::MITI//2203200312471570
:16S:LINK
:16R:STAT
:25D::IPRC//PACK
:16S:STAT
:16R:STAT
:25D::MTCH//NMAT
:16S:STAT
:16R:STAT
:25D::SETT//PEND

:16R:REAS
:24B::PEND//FUTU
:70D::REAS//AwaitingSettlementDate
:16S:REAS
:16S:STAT
:16S:GENL
:16R:SETTRAN
:35B:ISIN LU2128008567
:36B::SETT//UNIT/O,
:19A::SETT//NEUR50,06
:97A::SAFE//OCSD112100
:22F::SETR//PAIR
:22F::STCO//NPAR
:22H::REDE//DELI
:22H::PAYM//APMT
:98A::TRAD//20200322
:98C::ASTS//20200320114538
:98A::SETT//20200322
:16R:SETPRTY
:95P::PSET//OCSDATWWXXX
:16S:SETPRTY
:16R:SETPRTY
:95P::REAG//OCSDATWWXXX
:16S:SETPRTY
:16S:SETTRAN

1.4.3.3 MT548 - Status Message for Instruction Modification MT530

If a settlement instruction is modified by an MT530, the MT548 informs about execution results.

1.4.3.3.1 Content

M/O	Tag	Field Name	Qualifier	Option	Format	Codes	Description
Mandatory Sequence A General Information							
M	:16R:	Start of Block			16c	GENL	
M	:20C:	Sender's Reference	SEME		:4!c//16x		Sender's Message Reference
M	:23G:	Function of the Message			4!c	INST	Message reporting on an instruction status.
M	:98C:	Preparation Date/Time	PREP		:4!c//8!n6!n		Date and time at which message was prepared.
Mandatory Repetitive Subsequence A1 Linkages							
M	:16R:	Start of Block			16c	LINK	

M	:20C:	Reference	RELA	:4!c//16x		Reference of the linked message which was previously received.
			MITI		T2S Market Infrastructure Transaction Identification	
			PREV		Reference of the linked message which was previously sent.	
			PCTI		Processor Transaction Identification	
M	:16S:	End of Block		16c	LINK	
End of Subsequence A1 Linkages						
Mandatory Repetitive Subsequence A2 Status						
M	:16R:	Start of Block		16c	STAT	
M	:25D:	Processing Change Command Status	TPRC	:4!c//4!c	DEND	Modification request will not be executed.
					MODC	Modification has been completed.
					PACK	Modification Instruction has been acknowledged/accepted by the account servicer.
					REJT	Modification Instruction has been rejected for further processing.
Optional Repetitive Subsequence A2a Reason						
M	:16R:	Start of Block		16c	REAS	
M	:24B:	Denied Reason	DEND	:4!c/[8c]/4!c	DCAN	Modification request was denied since the instruction has already been cancelled.
					DSET	Modification request was denied because the instruction was already settled.
					NARR	See narrative field for reason.
or	:24B:	Rejection Reason	REJT	:4!c/[8c]/4!c	INVL	Unrecognised, invalid or missing link.

					INVM	Invalid or unrecognized modification request.
					NRGN	Cancellation or Transaction Processing Command request has been rejected since the instruction could not be found.
					REFE	Instruction has a reference identical to another previously received instruction.
					SAFE	Unrecognised or invalid message sender's safekeeping account.
					NARR	See narrative field for reason.
O	:70D:	Reason Narrative	REAS	:4!c//6*35x		Provides additional reason information.
M	:16S:	End of Block		16c	REAS	
						End of Subsequence A2a Reason
M	:16S:	End of Block		16c	STAT	
						End of Subsequence A2 Status
M	:16S:	End of Block		16c	GENL	
						End of Sequence A General Information

1.4.3.3.2 Explanation of the SWIFT Fields

Sequence A – General Information

— :23G: - Function of the Message

INST: Response for a modification instruction.

Optional Repetitive Subsequence A1 Linkages

— :20C: - Reference

RELA: This field contains the customer reference of the modification instruction referenced in the status message.

MITI: T2S reference of the referenced underlying instruction

PREV: Reference of the referenced underlying instruction (MT540, MT541, MT542 or MT543).

PCTI: This field contains the customer reference, if the instructing party differs from the account owner party. In this case the field RELA contains "NONREF". Exception: multicurrency instructions, transaction type External-CSD.

Mandatory Repetitive Subsequence A2 Status

— :25D: Processing Change Command Status

This field contains the status of the modification instruction.

DEND: The modification instruction will not be executed.

MODC: Informs about the completion of the modification instruction.

PACK: The modification instruction was accepted and is valid.

REJT: The modification instruction was rejected, because it could not be successfully validated.

Optional Repetitive Subsequence A2a Reason

— :24B: Denied Reason

This field contains the reason why an instruction can no longer be modified or why a Hold/Release status modification is no longer possible, i.e. why the modification instruction was denied.

DCAN: The modification instruction will not be executed, because the instruction concerned was already cancelled.

DSET: The modification instruction will not be executed, because the instruction concerned was already settled.

NARR: The reason for rejection is indicated in the free text field.

— :24B: Rejection Reason

This field contains the reason why the validation of the modification instruction not successful, i.e. why it was rejected.

INVL: The message sent contains a link that is not allowed or unknown.

INVM: The message sent contains a modification request that is not valid or unknown.

NRGN: The referenced instruction could not be found.

REFE: The instruction reference was recently used in an instruction.

SAFE: The message sent contains a securities account number that is not allowed or unknown.

NARR: The reason for rejection is indicated in the free text field.

1.4.3.3.3 MT548 Examples

Accepted

Information that the modification instruction ABCDEF modifying instruction UVWXYZ is valid.

:16R:GENL
:20C::SEME//CSDA00007
:23G:INST
:98C::PREP//20150103103025
:16R:LINK
:20C::RELA//ABCDEF
:16S:LINK
:16R:LINK
:20C::PREV//UVWXYZ
:16S:LINK
:16R:STAT
:25D::TPRC//PACK
:16S:STAT
:16S:GENL

Denied

Information that the modification instruction modifying instruction UVWXYZ was not executed, because the settlement instruction had already been cancelled or settled.

:16R:GENL
:20C::SEME//CSDA00007
:23G:INST
:98C::PREP//20150103103025
:16R:LINK
:20C::RELA//ABCDEF
:16S:LINK
:16R:LINK
:20C::PREV//UVWXYZ
:16S:LINK
:16R:STAT
:25D::TPRC//DEND
:16R:REAS
:24B::DEND//DSET
:70D::REAS//MMIA001-Settlement Instru ction referenced by an Amendment In struction is already settled.
:16S:REAS
:16S:STAT

:16S:GENL

Executed

Information that the modification instruction was completed.

:16R:GENL

:20C::SEME//CSDA00007

:23G:INST

:98C::PREP//20150103103025

:16R:LINK

:20C::RELA//ABCDEF

:16S:LINK

:16R:LINK

:20C::PREV//UVWXYZ

:16S:LINK

:16R:STAT

:**25D::TPRC//MODC**

:16S:STAT

:16S:GENL

Rejected

Information that the modification instruction was rejected, because it could not be successfully validated.

:16R:GENL

:20C::SEME//CSDA00007

:23G:INST

:98C::PREP//20150103103025

:16R:LINK

:20C::RELA//ABCDEF

:16S:LINK

:16R:LINK

:20C::PREV//UVWXYZ

:16S:LINK

:16R:STAT

:**25D::TPRC//REJT**

:16R:REAS

:24B::REJT//INVL

:**70D::REAS//MVCM959-The linkage speci**

fied in the Condition Modification

Instruction exists for the referenc

ed Settlement Instruction.

:16S:REAS

:16S:STAT

:16S:GENL

1.4.3.4 MT548 - Status Messages for a Cancellation Order

MT548 is used for responses to cancellation orders.

1.4.3.4.1 Content

M/O	Tag	Field Name	Qualifier	Option	Format	Codes	Description
Mandatory Sequence A General Information							
M	:16R:	Start of Block			16c	GENL	
M	:20C:	Sender's Reference	SEME		:4!c//16x		Sender's Message Reference
M	:23G:	Function of the Message			4!c	CAST	Message reporting on a cancellation request status.
M	:98C:	Preparation Date/Time	PREP		:4!c//8!n6!n		Date and time at which message was prepared.
Mandatory Repetitive Subsequence A1 Linkages							
M	:16R:	Start of Block			16c	LINK	
M	:20C:	Reference	RELA		:4!c//16x		Reference of the linked message which was previously received.
			MITI				T2S Market Infrastructure Transaction Identification
			PREV				Reference of the linked message which was previously sent.
			PCTI				Processor Transaction Identification
M	:16S:	End of Block			16c	LINK	
End of Subsequence A1 Linkages							
Mandatory Repetitive Subsequence A2 Status							
M	:16R:	Start of Block			16c	STAT	

M	:25D:	Cancellation Processing Status	CPRC	:4!c//4!c		A detailed description of the status and reason codes used can be found under 1.4.3.4.3
----------	-------	--------------------------------------	------	-----------	--	---

Optional Repetitive Subsequence A2a Reason

M	:16R:	Start of Block		16c	REAS	
M	:24B:	Cancellation Reason Pending Cancellation Reason Denied Reason Rejection Reason Acknowledged Reason	CAND CANP DEND REJT PACK	:4!c/[8c]/4!c		A detailed description of the status and reason codes used can be found under 1.4.3.4.3
O	:70D:	Reason Narrative	REAS	:4!c//6*35x		Provides additional reason information.
M	:16S:	End of Block		16c	REAS	

End of Subsequence A2a Reason

M	:16S:	End of Block		16c	STAT	
----------	-------	--------------	--	-----	------	--

End of Subsequence A2 Status

M	:16S:	End of Block		16c	GENL	
----------	-------	--------------	--	-----	------	--

End of Sequence A General Information

1.4.3.4.2 Explanation of the SWIFT Fields

Sequence A – General Information

- :23G: - Function of the Message
CAST: Response to a cancellation instruction.

Optional Repetitive Subsequence A1 Linkages

- :20C: - Reference
RELA: This field contains the customer reference of the MT543 SWIFT message that was sent.

MITI: Unique transaction reference of T2S.

Mandatory Repetitive Subsequence A2 Status

— :25D: Status

This field contains the status of the settlement instruction. Refer to 1.4.3.4.3 for a list of all codes used.

Optional Repetitive Subsequence A2a Reason

— :24B: - Reason

This field contains the reason code. Refer to 1.4.3.2.1 for a list of all codes used.

1.4.3.4.3 Status and Reason Codes

The following list contains the status and reason codes in use.

Reason	:25D: Status	Code	:24B: Reason	Code	Description
At least one CoSD Administering Party has not yet sent their CoSD Cancellation Instruction	CPRC	CANP	CANP	CDAC	Conditional Delivery Cancellation Pending
Cancellation instruction of partner is missing.	CPRC	CANP	CANP	CONF	Awaiting Confirmation
Reason indicated in free text field.	CPRC	CANP	CANP	NARR	Narrative Reason
Instruction cancelled due to customer order.	CPRC	CAND	CAND	CANI	Cancelled By Yourselves
Reason indicated in free text field.	CPRC	CAND	CAND	NARR	Narrative Reason
Securities account indicated in cancellation instruction does not exist or is not active. Sender of SWIFT message not authorised for indicated securities account.	CPRC	REJT	REJT	SAFE	Safekeeping Account Rejection
Instruction specified in the cancellation instruction was not found.	CPRC	REJT	REJT	NRGN	Instruction Not Found
Cancellation instruction reference is identical with another recently received instruction.	CPRC	REJT	REJT	REFE	Reference Rejection
Reason indicated in free text field.	CPRC	REJT	REJT	NARR	Narrative Reason
Reason indicated in free text field.	CPRC	DEND	DEND	NARR	Narrative Reason

Reason	:25D: Status	Code	:24B: Reason	Code	Description
Reason indicated in free text field.	CPRC	PACK	PACK	NARR	Narrative Reason

1.4.3.4.4 MT548 Examples

Accepted

The cancellation order was accepted.

```

:16R:GENL
:20C::SEME//CSDA00007
:23G:CAST
:98C::PREP//20150103103025
:16R:LINK
:20C::RELA//MSG300
:16S:LINK
:16R:LINK
:20C::MITI//T1290
:16S:LINK
:16R:LINK
:20C::PREV//REFABCD
:16S:LINK
:16R:STAT
:25D::CPRC//PACK
:16S:STAT
:16S:GENL

```

Rejected

Information, that the Cancel instruction of an already cancelled, settled or rejected instruction was rejected.

The participant sends a cancel instruction with the customer reference "Storno0303" for an already settled instruction.

```

:16R:GENL
:20C::SEME//EA00000000036CFD
:23G:CAST
:98C::PREP//20160303152956
:16R:LINK
:20C::RELA//Storno0303
:16S:LINK
:16R:STAT
:25D::CPRC//REJT
:16S:STAT
:16S:GENL

```

1.4.3.5 MT548 - Status Message for an Intra-Position Movement (Settlement Restriction)

MT548 is used for responses to intra-position movements (settlement restrictions (MT524)).

1.4.3.5.1 Content

M/O	Tag	Field Name	Qualifier	Option	Format	Codes	Description
Mandatory Sequence A General Information							
M	:16R:	Start of Block			16c	GENL	
M	:20C:	Sender's Reference	SEME		:4!c//16x		Sender's Message Reference
M	:23G:	Function of the Message			4!c	INST	Message reporting on an instruction status.
M	:98C:	Preparation Date/Time	PREP		:4!c//8!n6!n		Date and time at which message was prepared.

Mandatory Repetitive Subsequence A1 Linkages

M	:16R:	Start of Block			16c	LINK	
M	:20C:	Reference	RELA		:4!c//16x		Reference of the linked message which was previously received.
			MITI				T2S Market Infrastructure Transaction Identification
			PREV				Reference of the linked message which was previously sent.
			PCTI				Processor Transaction Identification
M	:16S:	End of Block			16c	LINK	

End of Subsequence A1 Linkages

Mandatory Repetitive Subsequence A2 Status

M	:16R:	Start of Block			16c	STAT	
---	-------	----------------	--	--	-----	------	--

M	:25D:	Instruction Processing Status	IPRC	:4!c//4!c		A detailed description of the status and reason codes used can be found under 1.4.3.5.3
		Settlement Status	SETT			

Optional Repetitive Subsequence A2a Reason

M	:16R:	Start of Block		16c	REAS	
M	:24B:	Cancellation Reason	CAND	:4!c/[8c]/4!c		A detailed description of the status and reason codes used can be found under 1.4.3.5.3
		Pending Reason	PEND			
		Pending/Failing Reason	PENF			
		Rejection Reason	REJT			
		Acknowledgement Reason	PACK			
O	:70D:	Reason Narrative	REAS	:4!c//6*35x		Provides additional reason information.
M	:16S:	End of Block		16c	REAS	

End of Subsequence A2a Reason

M	:16S:	End of Block		16c	STAT	
----------	-------	--------------	--	-----	------	--

End of Subsequence A2 Status

M	:16S:	End of Block		16c	GENL	
----------	-------	--------------	--	-----	------	--

End of Sequence A General Information

1.4.3.5.2 Explanation of the SWIFT Fields

Sequence A – General Information

— :23G: - Function of the Message

INST: Response to a settlement instruction.

Optional Repetitive Subsequence A1 Linkages

— :20C: - Reference

LINK: SWIFT message type of instruction referenced in status message.

RELA: This field contains the customer reference of the MT543 SWIFT message that was sent.

MITI: Unique transaction reference of T2S.

PREV: Reference of the underlying instruction.

PCTI This field contains the customer reference, if the instructing party differs from the account owner party. In this case the field RELA contains "NONREF".

Mandatory Repetitive Subsequence A2 Status

— :25D: Status

This field contains the status of the settlement instruction. Refer to 1.4.3.5.3 for a list of all codes used.

Optional Repetitive Subsequence A2a Reason

— :24B: - Reason

This field contains the reason code. Refer to 1.4.3.5.3 for a list of all codes used (PEND and PENF are not combinable).

Distinction PEND and PENF

PEND will be used when settlement of the instruction is still possible at ISD.

PENF will be used when settlement of the instruction is no longer possible at ISD (after relevant cut-offs for FOP).

1.4.3.5.3 Status and Reason Codes

Reason	:25D: Status	Code	:24B: Reason	Code	Description
Information that the settlement restriction was cancelled due to customer order.	IPRC	CAND	CAND	CANI	Cancelled By Yourselves
Information that the settlement restriction was cancelled by the system.	IPRC	CAND	CAND	CANS	Cancelled By System
Information that the settlement restriction was cancelled by a third party.	IPRC	CAND	CAND	CTHP	Cancelled By Third Party
Information that the settlement restriction was cancelled. Reason indicated in free text field.	IPRC	CAND	CAND	NARR	Narrative Reason
Reason indicated in free text field.	IPRC	PACK	PACK	NARR	Narrative Reason
Instruction rejected due to invalid settlement date.	IPRC	REJT	REJT	DDAT	Settlement Date Rejection

Reason	:25D: Status	Code	:24B: Reason	Code	Description
Settlement restriction rejected due to unknown or invalid settlement quantity.	IPRC	REJT	REJT	DQUA	Quantity Rejection
Settlement restriction rejected due to unknown or invalid ISIN.	IPRC	REJT	REJT	DSEC	Security Rejection
Settlement restriction rejected due to invalid or missing sub-balance type.	IPRC	REJT	REJT	INVB	Balance Rejection
Settlement restriction rejected due to unknown, invalid or missing link.	IPRC	REJT	REJT	INVL	Link Rejection
Settlement restriction rejected due to unknown, invalid or missing lot number.	IPRC	REJT	REJT	INVN	Number Rejection
Settlement restriction rejected, as minimum instruction quantity was not observed.	IPRC	REJT	REJT	MINO	Minimum Settlement Quantity
Settlement restriction rejected, as smallest denomination was not observed.	IPRC	REJT	REJT	MUNO	Multiple Settlement Quantity
Settlement restriction rejected, as instruction reference is identical with another recently received instruction.	IPRC	REJT	REJT	REFE	Reference Rejection
Settlement restriction rejected, as securities account indicated does not exist or is not active.	IPRC	REJT	REJT	SAFE	Safekeeping Account Rejection
Settlement restriction rejected, as sender of SWIFT message is not authorised for indicated securities account.					
Settlement restriction rejected due to validation rules.	IPRC	REJT	REJT	VALR	Validation Rule Rejection
Reason indicated in free text field.	IPRC	REJT	REJT	NARR	Narrative Reason
Information that securities account is blocked.	SETT	PEND	PEND	BLOC	Account Blocked
		PENF	PENF		
Not all linked-to instructions of a pool have yet been received.	SETT	PEND	PEND	INBC	Incomplete Number Count
		PENF	PENF		

Reason	:25D: Status	Code	:24B: Reason	Code	Description
Information that instruction was approved and that there are no more Holds. Instruction is waiting for settlement date.	SETT	PEND	PEND	FUTU	Awaiting Settlement Date
Securities account of customer contains insufficient coverage for delivery.	SETT	PEND PENF	PEND PENF	LACK	Lack of Securities
Instruction was submitted after market deadline.	SETT	PEND PENF	PEND PENF	LATE	Market Deadline Missed
Instruction status is "pending", as linked-to instruction status is "pending".	SETT	PEND PENF	PEND PENF	LINK	Pending Linked Instruction
Information that instruction was partially settled, but part remains to be settled.	SETT	PEND PENF	PEND PENF	PART	Trade Settles in Partials
Information that securities position is blocked.	SETT	PEND PENF	PEND PENF	SBLO	Securities Blocked
Reason indicated in free text field.	SETT	PEND PENF	PEND PENF	NARR	Narrative Reason
Instruction is waiting for settlement.	SETT	PENF	PENF	CYCL	Awaiting Next Settlement Cycle

1.4.3.5.4 MT548 Examples

Cancellation

Information that the settlement restriction was cancelled due to customer order.

```

:16R:GENL
:20C::SEME//CSDA00007
:23G:INST
:98C::PREP//20150103103025
:16R:LINK
:20C::RELA//REFBCD
:16S:LINK
:16R:LINK
:20C::MITI//T1234
:16S:LINK

```

:16R:STAT
:25D::IPRC//CAND
:16R:REAS
:24B::CAND//CANI
:16S:REAS
:16S:STAT
:16S:GENL

Link

Information that the instruction status is "pending", because the linked-to instruction status is "pending".

:16R:GENL
:20C::SEME//CSDA00007
:23G:INST
:98C::PREP//20150103103025
:16R:LINK
:20C::RELA//REFBCD
:16S:LINK
:16R:LINK
:20C::MITI//T1234
:16S:LINK
:16R:STAT
:25D:SETT//PEND
:16R:REAS
:24B::PEND//LINK
:70D::REAS//SPST012-Settlement Restri ction is unsettled because its link ed settlement instruction is suspen ded
:16S:REAS
:16S:STAT
:16S:GENL

1.4.4 Settlement Allegement – MT578

1.4.4.1 MT578 – Settlement Allegement

In case of multicurrency instructions no allegements will be sent.

1.4.4.1.1 Content

M/O	Tag	Field Name	Qualifier	Option	Format	Codes	Description
Mandatory Sequence A General Information							
M	:16R:	Start of Block			16c	GENL	

M/O	Tag	Field Name	Qualifier	Option	Format	Codes	Description
M	:20C:	Sender's Reference	SEME		:4!c//16x		Reference assigned by the sender to unambiguously identify the message
M	:23G:	Function of the Message			4!c	NEWM REMO CANC	New message Removal message Cancellation request
M	:98C:	Preparation Date/Time	PREP		:4!c//8!n6!n		Date and time at which message was prepared.

Optional Repetitive Subsequence A1 Linkages

M	:16R:	Start of Block			16c	LINK	
M	:20C:	Reference	RELA		:4!c//16x		Related Message Reference
			PREV				Previous Message Reference
			COMM				Common Reference
			MITI				Market Infrastructure Transaction Identification
M	:16S:	End of Block			16c	LINK	

End of Subsequence A1 Linkages

M	:16S:	End of Block			16c	GENL	
---	-------	--------------	--	--	-----	------	--

End of Sequence A General Information

Mandatory Sequence B Trade Details

M	:16R:	Start of Block			16c	TRADDET	
O	:94H:	Place of Clearing	CLEA		:4!c//4!a2!a2!c[3!c]		Place at which the trade is cleared (Central Counterparty).
O	:94B:	Place of Trade	TRAD		:4!c/[8c]/4!c/30x]	EXCH OTCO PRIM SECM	Place of trade is a stock exchange. Place of trade is over the counter. Place of trade is the primary market. Place of trade is the secondary market.

M/O	Tag	Field Name	Qualifier	Option	Format	Codes	Description
						VARI	Trade was executed on various places.
O	:98a:	Trade Date/Time	TRAD	A	:4!c//8!n		Date at which the trade was executed.
				C	:4!c//8!n6!n		Date and time at which the trade was executed.
M	:98a:	Settlement Date/Time	SETT	A	:4!c//8!n		Date at which the financial instruments are to be delivered or received.
				C	:4!c//8!n6!n		Date and time at which the financial instruments are to be delivered or received.
M	:35B:	Identification of the Financial Instrument			ISIN!1e12!c		"ISIN" followed by <Blank> and ISIN Code
O	:22F:	Trade Transaction Condition Indicator	TTCO		:4!c/[8c]/4!c	CCPN	Trade was executed cum coupon.
						XCPN	Trade was executed ex coupon.
M	:22H:	Receive/Deliver Indicator	REDE		:4!c/[8c]/4!c	DELI	Counterparty's instruction is a delivery.
						RECE	Counterparty's instruction is a receipt.
O	:22H:	Payment Indicator	PAYM		:4!c/[8c]/4!c	APMT	Counterparty's instruction is against payment.
						FREE	Counterparty's instruction is free of payment.
M	:16S:	End of Block			16c	TRADEDET	
End of Sequence B Trade Details							
Mandatory Sequence C Financial Instrument/Account							
M	:16R:	Start of Block			16c	FIAC	
M	:36B:		SETT		:4!c//4!c/15d	FAMT	Face amount

M/O	Tag	Field Name	Qualifier	Option	Format	Codes	Description
		Quantity of Financial Instrument to be Settled				UNIT	Unit number
O	:95P:	Party	ACOW		:4!c//4!a2!a2!c[3!c]		Account owner
M	:97A:	Safekeeping Account	SAFE		:4!c//35x		OeKB CSD's securities account number of the customer
M	:16S:	End of Block			16c	FIAC	
End of Sequence C Financial Instrument/Account							
Mandatory Sequence E Settlement Details							
M	:16R:	Start of Block			16c	SETDET	
M	:22F:	Type of Settlement Transaction	SETR		:4!c/[8!c]/4!c	TRAD	Specifies underlying information regarding the type of settlement transaction
						CLAI	Transaction resulting from a market claim.
					:4!c/COEX/4!c	CORP	Relates to a transaction generated as a result of a corporate action
O	:22F:	Settlement Transaction Condition Indicator	STCO		:4!c/[8c]/4!c	NPAR	Partial settlement is not allowed.
						PART	Partial settlement is allowed.
						NOMC	No market claim should be automatically generated.
					:4!c/COEX/4!c	PARQ	Partial Settlement is Allowed with Minimum Quantity
						PARC	Partial Settlement is Allowed with Minimum Cash Value
					:4!c/REGL/4!c	BSSP	Instruction Resulting form Partially Successful Buy-In

M/O	Tag	Field Name	Qualifier	Option	Format	Codes	Description
O	:22F:	Beneficial Ownership Indicator	BENE		:4!c/[8c]/4!c	NBEN	No Change of Beneficial Ownership (NCBO)
						YBEN	Change of Beneficial Ownership (CBO)
Mandatory Repetitive Subsequence E1 Settlement Parties							
M	:16R:	Start of Block			16c	SETPRTY	
M	:95P:	Place of Settlement	PSET		:4!c//4!a2!a2!c[3!c]		Place of settlement (depository)
M	:16S:	End of Block			16c	SETPRTY	
(M)	:16R:	Start of Block			16c	SETPRTY	
(M)	:95P:	Receiving Agent	REAG		:4!c//4!a2!a2!c[3!c]		Receiving party that interacts with the place of settlement
O	:97A:	Safekeeping Account	SAFE		4!c//35x		Counterparty's securities acc. number
(M)	:16S:	End of Block			16c	SETPRTY	
O	:16R:	Start of Block			16c	SETPRTY	
O	:95a:	Receiver's Intermediary 2	REI2	P	:4!c//4!a2!a2!c[3!c]		Party that interacts with the receiver's intermediary 1
				R	:4!c/8!c/34x		
				Q	:4!c//4*35x		
O	:97A:	Safekeeping Account	SAFE		4!c//35x		Securities acc. number of Party that interacts with the receiver's intermediary 1
O	:16S:	End of Block			16c	SETPRTY	
O	:16R:	Start of Block			16c	SETPRTY	
O	:95a:	Receiver's Intermediary 1	REI1	P	:4!c//4!a2!a2!c[3!c]		Party that interacts with the receiving agent
				R	:4!c/8!c/34x		
				Q	:4!c//4*35x		
O	:97A:	Safekeeping Account	SAFE		4!c//35x		Securities acc. number of Party that interacts with the receiving agent
O	:16S:	End of Block			16c	SETPRTY	
O	:16R:	Start of Block			16c	SETPRTY	

M/O	Tag	Field Name	Qualifier	Option	Format	Codes	Description
O	:95a:	Receiver's Custodian	RECU	P	:4!c//4!a2!a2!c[3!c]		Party that interacts with the receiving agent unless intermediaries exist
				R	:4!c/8!c/34x		
				Q	:4!c//4*35x		
O	:97A:	Safekeeping Account	SAFE		4!c//35x		Securities acc. number of Party that interacts with the receiving agent unless intermediaries exist
O	:16S:	End of Block			16c	SETPRTY	
O	:16R:	Start of Block			16c	SETPRTY	
O	:95a:	Buyer	BUYR	P	:4!c//4!a2!a2!c[3!c]		Party that receives the financial instrument
				R	:4!c/8!c/34x		
				Q	:4!c//4*35x		
O	:97A:	Safekeeping Account	SAFE		4!c//35x		Securities acc. number of Party that receives the financial instrument
O	:16S:	End of Block			16c	SETPRTY	
(M)	:16R:	Start of Block			16c	SETPRTY	
(M)	:95P:	Delivering Agent	DEAG		:4!c//4!a2!a2!c[3!c]	SETPRTY	Delivering party that interacts with the place of settlement.
O	:97A:	Safekeeping Account	SAFE		4!c//35x		Counterparty's securities acc. number
(M)	:16S:	End of Block			16c	SETPRTY	
O	:16R:	Start of Block			16c	SETPRTY	
O	:95a:	Deliverer's Intermediary 2	DEI2	P	:4!c//4!a2!a2!c[3!c]		Party that interacts with the deliverer's intermediary 1
				R	:4!c/8!c/34x		
				Q	:4!c//4*35x		
O	:97A:	Safekeeping Account	SAFE		4!c//35x		Securities acc. number of Party that interacts with the deliverer's intermediary 1
O	:16S:	End of Block			16c	SETPRTY	
O	:16R:	Start of Block			16c	SETPRTY	
O	:95a:		DEI1	P	:4!c//4!a2!a2!c[3!c]		

M/O	Tag	Field Name	Qualifier	Option	Format	Codes	Description
		Deliverer's Intermediary 1		R	:4!c/8!c/34x		Party that interacts with the delivering agent
				Q	:4!c//4*35x		
O	:97A:	Safekeeping Account	SAFE		4!c//35x		Securities acc. number of Party that interacts with the delivering agent
O	:16S:	End of Block			16c	SETPRTY	
O	:16R:	Start of Block			16c	SETPRTY	
O	:95a:	Deliverer's Custodian	DECU	P	:4!c//4!a2!a2!c[3!c]		Party that interacts with the delivering agent unless intermediaries exist
				R	:4!c/8!c/34x		
				Q	:4!c//4*35x		
O	:97A:	Safekeeping Account	SAFE		4!c//35x		Securities acc. number of Party that interacts with the delivering agent unless intermediaries exist
O	:16S:	End of Block			16c	SETPRTY	
O	:16R:	Start of Block			16c	SETPRTY	
O	:95a:	Seller	SELL	P	:4!c//4!a2!a2!c[3!c]		Party that delivers the financial instrument
				R	:4!c/8!c/34x		
				Q	:4!c//4*35x		
O	:97A:	Safekeeping Account	SAFE		4!c//35x		Securities acc. number of Party that delivers the financial instrument
O	:16S:	End of Block			16c	SETPRTY	
End of Subsequence E1 Settlement Parties							
Optional Repetitive Subsequence E3 Amount							
M	:16R:	Start of Block			16c	AMT	
M	:19A:	Settlement Amount	SETT		:4!c//[N]3!a15d		ISO-Currency code followed by cash amount
M	:16S:	End of Block			16c	AMT	
End of Subsequence E3 Amount							
M	:16S:	End of Block			16c	SETDET	
End of Sequence E Settlement Details							

1.4.4.1.2 Explanation of the SWIFT Fields

Sequence A – General Information

— :23G: - Function of the Message

NEWM: New instruction.

REMO: Removal of an allegation (after successful matching).

CANC: Cancellation of the allegation (original counterparty instruction was cancelled).

Optional Repetitive Subsequence A1 Linkages

— :20C: - Reference

RELA: Customer reference of the referenced counterparty instruction (the instruction triggering the allegation); is only provided in case of a MT578 NEWM.

PREV: Senders Reference (SEME) of MT578 NEWM, which is being cancelled or removed; is only provided in case of MT578 CANC or MT578 REMO.

MITI: Unique transaction reference of T2S (reference of the counterparty instruction); is only provided in case of MT578 NEWM.

COMM: Unique reference agreed between two counterparties to identify the instruction.

Mandatory Sequence B Trade Details

— :22F: - Trade Transaction Condition Indicator

TTCO: This qualifier specifies whether the security is delivered with (CCPN – Cum Coupon) or without (XCPN – Ex Coupon) coupon (additional matching field).

Mandatory Sequence C Financial Instrument/Account

— :95P: Account Owner

BIC Code of the receiving party

— :97A: Safekeeping Account

Securities account number of receiving party; in case the counterparty provides the securities account number in REAG/DEAG, this account will be used, otherwise the securities account marked as Default Securities Account will be used.

Mandatory Sequence E Settlement Details

— :22F: - Settlement Transaction Condition Indicator

NPAR: Counterparty does not allow partial settlement.

PART: Counterparty allows partial settlement.

PARQ: Partial Settlement is allowed with Minimum Quantity

PARC: Partial Settlement is allowed with Minimum Cash Value

NOMC: Opt-out indicator (additional matching field).

BSSP: Instruction Resulting form Partially Successful Buy-In. If the matching instruction is also instructed with this Settlement Transaction Condition both instructions will be exempt from Late Matching penalty fees. It is not a matching field.

Mandatory Repetitive Subsequence E1 Settlement Parties

— :95P: - Place of Settlement

PSET: BIC of the counterparty's CSD (depository).

— :95P: - Receiving Agent/Delivering Agent

This field is used to identify the counterparty using the BIC. The securities account of the counterparty is always provided, the securities account of the receiving party is only filled in case the counterparty did provided it in REAG/DEAG.

1.4.4.1.3 Differentiation of Instruction Types in MT578

See 1.4.3.2, Differentiation of Instruction Types in MT548.

1.4.4.1.4 MT578 Examples

New Allegement

Allegement for example MT543-example with customer reference "DVP10000".

:16R:GENL
:20C::SEME//1603030098345452
:23G:NEWM
:98C::PREP//20160303100512
:16R:LINK
:20C::MITI//1603030098344135
:16S:LINK
:16R:LINK
:20C::RELA//DVP10000
:16S:LINK
:16S:GENL
:16R:TRADDET
:98A::TRAD//20160303
:98A::SETT//20160307
:35B:ISIN AT000BSP0000
:22H::REDE//DELI
:22H::PAYM//APMT
:16S:TRADDET
:16R:FIAC

:36B::SETT//FAMT/1000,
:95P::ACOW//SLHYAT2SXXX
:97A::SAFE//OCSD224400
:16S:FIAC
:16R:SETDET
:22F::SETR//TRAD
:22F::STCO//NPAR
:16R:SETPRTY
:95P::PSET//OCSDATWWXXX
:16S:SETPRTY
:16R:SETPRTY
:95P::DEAG//RZTIAT22XXX
:97A::SAFE//OCSD237400
:16S:SETPRTY
:16R:SETPRTY
:95P::REAG//SLHYAT2SXXX
:97A::SAFE//OCSD224400
:16S:SETPRTY
:16R:AMT
:19A::SETT//EUR100,10
:16S:AMT
:16S:SETDET

Removal of Allegement

The customer with securities account number OCSD23700 has entered the counter instruction for the MT543 with customer reference "DVP10000".

:16R:GENL
:20C::SEME//1015186094
:23G:REMO
:98C::PREP//20160917060000
:16R:LINK
:20C::PREV//1603030098345452
:16S:LINK
:16S:GENL
:16R:TRADEDET
:98A::SETT//20160307
:35B:ISIN AT000BSP0000
:22H::REDE//DELI
:22H::PAYM//APMT
:16S:TRADEDET
:16R:FIAC
:36B::SETT//FAMT/1000,
:95P::ACOW//SLHYAT2SXXX

:97A::SAFE//OCSD224400
:16S:FIAC
:16R:SETDET
:22F::SETR//TRAD
:16R:SETPRTY
:95P::DEAG//RZTIAT22XXX
:16S:SETPRTY
:16R:SETPRTY
:95P::PSET//OCSDATWWXXX
:16S:SETPRTY
:16R:SETPRTY
:95P::REAG//SLHYAT2SXXX
:16S:SETPRTY
:16R:AMT
:19A::SETT//EUR100,10
:16S:AMT
:16S:SETDET

New Allegement

Information that instruction of counterparty exists.

:16R:GENL
:20C::SEME//OCSD000012
:23G:NEWM
:98C::PREP//20160301094000
:16R:LINK
:20C::RELA//REFABCD02
:16S:LINK
:16R:LINK
:20C::MITI//T1400
:16S:LINK
:16S:GENL
:16R:TRADEDET
:98A::TRAD//20160301
:98A::SETT//20160304
:35B:ISIN ISIN00000001
:22H::PAYM//FREE
:22H::REDE//DELI
:16S:TRADEDET
:16R:FIAC
:36B::SETT//UNIT/2000,
:97A::SAFE//OCSD123400
:16S:FIAC
:16R:SETDET

:22F::SETR//TRAD

:22F::STCO//PART

:16R:SETPRTY

:95P::PSET//OCSDATWWXXX

:16S:SETPRTY

:16R:SETPRTY

:95P::DEAG//BNPAFRPPXXX

:97A::SAFE//OCSD124500

:16S:SETPRTY

:16R:SETPRTY

:95P::REAG//BKAUATWWXXX

:97A::SAFE//OCSD123400

:16S:SETPRTY

:16S:SETDET

Cancellation of an Allegement

:16R:GENL

:20C::SEME//OCSD000013

:23G:CANC

:98C::PREP//20160301095000

:16R:LINK

:20C::PREV//OCSD000012

:16S:LINK

:16S:GENL

:16R:TRADDET

:98A::TRAD//20160301

:98A::SETT//20160304

:35B:ISIN ISIN00000001

:22H::PAYM//FREE

:22H::REDE//DELI

:16S:TRADDET

:16R:FIAC

:36B::SETT//UNIT/2000,

:95P::ACOW//BKAUATWWXXX

:97A::SAFE//OCSD123400

:16S:FIAC

:16R:SETDET

:22F::SETR//TRAD

:22F::STCO//PART

:16R:SETPRTY

:95P::PSET//OCSDATWWXXX

:16S:SETPRTY

:16R:SETPRTY

:95P::DEAG//BNPAFRPPXXX

:97A::SAFE//OCSD124500

:16S:SETPRTY

:16R:SETPRTY

:95P::REAG//BKAUATWWXXX

:97A::SAFE//OCSD123400

:16S:SETPRTY

:16S:SETDET

1.4.5 Intra-Position Movement (Settlement Restrictions) – MT524 and MT508

Intra-position movements can be used to flag individual positions on a securities account. Sub-balances are calculated accordingly. The available restrictions are Blocking, Reservation and Earmarking (for auto-collateralisation).

1.4.5.1 MT524 – Intra-Position Transfer (Intra-Position Instruction)

MT524 is used for intra-position movements - flagging of sub-balances of securities account positions - e.g. blocking, reservation and earmarking.

1.4.5.1.1 Content

M/O	Tag	Field Name	Qualifier	Option	Format	Codes	Description
Mandatory Sequence A General Information							
M	:16R:	Start of Block			16c	GENL	
M	:20C:	Sender's Reference	SEME		:4!c//16x		Reference assigned by the sender to unambiguously identify the message
M	:23G:	Function of the Message			4!c	NEWM CANC	New message Message requesting the cancellation of a previously sent message.
O	:99B	Number Count	SETT		:4!c//3!n	000-999	Sequential number of the instruction in a range of linked instructions.
O	:99B	Number Count	TOSE		:4!c//3!n	000-999	Total number of instructions that are linked together.
O	:22F:		PRIR		:4!c/[8c]/4!c	0003	High priority

		Priority Indicator			0004	Normal priority	
Optional Subsequence A1 Linkages							
M	:16R:	Start of Block			16c	LINK	
M	:20C:	Reference	RELA		:4!c//16x	Related Message Reference	
			PREV			Previous Message Reference	
			POOL			Pool Reference	
O	:22F:	Linkage Type Indicator	LINK			AFTE	
						Indicates that the message is to be processed after the linked message.	
				BEFO		Indicates that the message is to be processed before the linked message.	
						WITH	Indicates that the message is to be processed with the linked transaction.
M	:16S:	End of Block			16c	LINK	
End of Subsequence A1 Linkages							
M	:16S:	End of Block			16c	GENL	
End of Sequence A General Information							
Mandatory Sequence B Intra-Position Details							
M	:16R:	Start of Block			16c	INPOSDET	
M	:97A:	Safekeeping Account	SAFE	A	:4!c//35x	Counterparty's securities acc. number	
M	:36B:	Quantity of Financial Instrument Settled	SETT		:4!c//4!c/15d	FAMT	
						Face amount	
						UNIT	Unit number

O	:13B:	Securities Sub- balance Identifier	SSBI	:4!c/[8c]/30x		Number identifying a sub-balance constituting a quantity of financial instrument.
M	:35B:	Identification of the Financial Instrument		ISIN1!e12!c		"ISIN" followed by <Blank> and ISIN Code
				4*35x		Description of the financial instrument (optional)
M	:98C:	Settlement Date	SETT	:4!c//8!n6!n		Date and time at which the financial instruments are to be moved.
M	:93A:	Balance From	FROM	:4!c//4!c	AWAS	Balance of financial instruments that are freely available with no specific additional status.
				:4!c/[8c]/4!c		Data Source Scheme = /RT/ see chapter 1.4.5.1.2
M	:93A:	Balance To	TOBA	:4!c//4!c	AWAS	Balance of financial instruments that are freely available with no specific additional status.
				:4!c/[8c]/4!c		Data Source Scheme = /RT/ see chapter 1.4.5.1.2
M	:16S:	End of Block		16c	INPODET	

[End of Sequence B Intra-Position Details](#)

1.4.5.1.2 Explanation of the SWIFT Fields

Mandatory Sequence A General Information

- :23G: - Function of the Message

NEWM: New instruction.

CANC: Cancellation of the instruction (indication of :20C: PREV in Optional Subsequence A1 Linkages mandatory).

- :99B: - Number Count

Instructions with a pool reference must include a pool counter indicating the total number of linked instructions.

SETT: If a pool reference is indicated in :20C: in Optional Subsequence A1 Linkages, :99B: must be filled.

TOSE: If a pool reference is indicated in :20C: in Optional Subsequence A1 Linkages, :99B: must be filled.

- :22F: - Settlement Priority Indicator

The priority can be changed from "High Priority (0003)" to "Normal Priority (0004)" and vice versa.

Optional Repetitive Subsequence A1 Linkages

- :20C: - Reference

RELA: Customer reference of the referenced instruction (e.g. if :22F: is filled in Optional Subsequence A1).

PREV: Customer reference of an earlier instruction (e.g. if A:23G:CANC is specified in the Mandatory Sequence A General Information, the reference of the settlement restriction instruction is indicated here).

POOL: A pool reference can be used to link more than two instructions. It is a collective reference for a set of settlement instructions which must be settled collectively "all-or-none".

- :22F: - Linkage Type Indicator

AFTE: Current instruction will be settled AFTER the linked-to instruction.

BEFO: Current instruction will be settled BEFORE the linked-to instruction.

WITH: Current instruction will be settled together WITH the linked-to instruction.

Mandatory Sequence B Intra-Position Details

- :13B: - SSBI: Securities Sub-balance Identifier

In case of an increase or decrease of positions already blocked or reserved the restriction reference number must be indicated here. This reference number is sent with every execution confirmation MT508 (for blocking or reservation).

- :93A: - Balance From/To

Balance From and Balance To must not contain identical codes.

FROM: The sub-balance from which units are transferred. If the code is not AWAS, Data Source Scheme /RT/ with the corresponding code (BLOn, RESn, EARn, EEUR) must be indicated.

TOBA: The sub-balance to which units are transferred. If the code is not AWAS, Data Source Scheme /RT/ with the corresponding code (BLOn, RESn, EARn, EEUR) must be indicated.

AWAS = (deliverable) position available without restriction.

BLOn, RESn, EARn: *The restriction type definitions (codes) are still subject to change. More types may be added or the listed types may be modified.*

1.4.5.1.3 MT524 Examples

Blocking of Securities Positions (Set up)

On a securities account there is a position of 1000 units (AWAS). 600 units shall be blocked. The settlement restriction includes the following:

- Quantity: 600
- Sub-balance from: AWAS
- Sub-balance to: BLO1

:16R:GENL
:20C::SEME//111111
:23G:NEWM
:16S:GENL
:16R:INPOSDET
:97A::SAFE//OCSD227600
:36B::SETT//UNIT/600,
:35B:ISIN AT0000800800
Pankl Racing SYS
:98A::SETT//20141030
:93A::FROM//AWAS
:93A::TOBA/RT/BLO1
:16S:INPOSDET

Earmarking of Securities Positions (Set up)

On a securities account there is a position of 100,000 units of a government bond (AT0000A105W3) which shall be earmarked as collateral.

:16R:GENL
:20C::SEME//33333
:23G:NEWM
:16S:GENL
:16R:INPOSDET
:97A::SAFE//OCSD227600

:36B::SETT//FAMT/100000,
:35B:AT0000A105W3
Bundesanl13-23/2
:98A::SETT//20141030
:93A::FROM//AWAS
:93A::TOBA/RT/EAR1
:16S:INPOSDET

Increase of a Blocked Position

200 more units (from the first example) shall be blocked. The restriction reference number of T2S is T2S123456.

- Quantity: 200
- SSBI: T2S123456
- Sub-balance from: AWAS
- Sub-balance to: BLO1

:16R:GENL
:20C::SEME//4444
:23G:NEWM
:16S:GENL
:16R:INPOSDET
:97A::SAFE//OCSD227600
:36B::SETT//UNIT/200,
:13B::SSBI//T2S123456
:35B:ISIN AT0000800800
Pankl Racing SYS
:98A::SETT//20141030
:93A::FROM//AWAS
:93A::TOBA/RT/BLO1
:16S:INPOSDET

Decrease of a Reservation

A reserved position of 500 units DE000LED4000 (RES1 with restriction reference number T2S000111) shall be returned to be a position available without restriction.

:16R:GENL
:20C::SEME//55555
:23G:NEWM
:16S:GENL
:16R:INPOSDET
:97A::SAFE//OCSD227600
:36B::SETT//UNIT/500,
:13B::SSBI//T2S000111

:35B:ISIN DE000LED4000
Osram Licht Aktie
:98A::SETT//20141030
:93A::FROM/RT/RES1
:93A::TOBA//AWAS
:16S:INPOSDET

1.4.5.2 MT508 – Confirmation of an Intra-Position Transfer (Intra-Position Advice)

MT508 is used to confirm a settlement restriction MT524 (e. g. blocking, reservation and earmarking).

1.4.5.2.1 Content

M/O	Tag	Field Name	Qualifier	Option	Format	Codes	Description
Mandatory Sequence A General Information							
M	:16R:	Start of Block			16c	GENL	
M	:20C:	Sender's Reference	SEME		:4!c//16x		Reference assigned by the sender to unambiguously identify the message
M	:23G:	Function of the Message			4!c	NEWM	New message
						CANC	Message requesting the cancellation of a previously sent message.
M	:98C:	Preparation Date/Time	PREP		:4!c//8!n6!n		Date and time at which message was prepared.
Optional Subsequence A1 Linkages							
M	:16R:	Start of Block			16c	LINK	
M	:20C:	Reference	RELA		:4!c//16x		Related Message Reference
			PREV				Previous Message Reference
			POOL				Pool Reference
			MITI				Market Infrastructure Transaction Identification
			PCTI				Processor Transaction Identification
M	:16S:	End of Block			16c	LINK	

M/O	Tag	Field Name	Qualifier	Option	Format	Codes	Description
End of Subsequence A1 Linkages							
M	:16S:	End of Block			16c	GENL	
End of Sequence A General Information							
Mandatory Sequence B Intra-Position Details							
M	:16R:	Start of Block			16c	INPOSDET	
O	:95P:	Account Owner	ACOW		:4!c//4!a2!a2!c[3!c]		Party that owns the account
M	:97A:	Safekeeping Account	SAFE	A	:4!c//35x		Counterparty's securities acc. number
M	:36B:	Quantity of Financial Instrument Settled	ESTT		:4!c//4!c/15d	FAMT UNIT	Face amount Unit number
O	:36B:	Quantity of Financial Instrument Previously Settled	PSTT		:4!c//4!c/15d	FAMT UNIT	Face amount Unit number
O	:36B:	Quantity of Financial Instrument Remaining to be Settled	RSTT		:4!c//4!c/15d	FAMT UNIT	Face amount Unit number
O	:13B:	Securities Sub-balance Identifier	SSBI		:4!c/[8c]/30x		Number identifying a sub-balance constituting a quantity of financial instrument.
M	:35B:	Identification of the Financial Instrument			ISIN1!e12!c		"ISIN" followed by <Blank> and ISIN Code
M	:98C:	Settlement Date/Time	SETT		:4!c//8!n6!n		Date and time at which the financial instruments are to be moved.
O	:22F:	Partial Settlement Indicator	PARS		:4!c/[8c]/4!c	PAIN	Confirmation is for partial settlement. Part of the instruction remains unsettled.

M/O	Tag	Field Name	Qualifier	Option	Format	Codes	Description
						PARC	Confirmation is for partial settlement. No additional settlement will take place.
M	:93A:	Balance From	FROM		:4!c//4!c	AWAS	Balance of financial instruments that are freely available with no specific additional status.
					:4!c/[8c]/4!c		Data Source Scheme = /RT/
M	:93A:	Balance To	TOBA		:4!c//4!c	AWAS	Balance of financial instruments that are freely available with no specific additional status.
					:4!c/[8c]/4!c		Data Source Scheme = /RT/
M	:16S:	End of Block			16c	INPOSDET	

End of Sequence B Intra-Position Details

1.4.5.2.2 Explanation of the SWIFT Fields

Mandatory Sequence A General Information

— :23G: - Function of the Message

NEWM: New instruction.

CANC: Cancellation of a settlement restriction instruction.

Optional Repetitive Subsequence A1 Linkages

— :20C: - Reference

RELA: Customer reference of the referenced instruction.

PREV: Customer reference of an earlier instruction.

POOL: A pool reference can be used to link more than two instructions. It is a collective reference for a set of settlement instructions which must be settled collectively "all-or-none".

MITI: Unique transaction reference of T2S.

PCTI: This field contains the customer reference, in case a SWIFT message is sent for a securities account with a given power of attorney.

Mandatory Sequence B Intra-Position Details

— :36B: - Quantity of Financial Instrument Settled

ESTT: The actual quantity of securities settled. In case of partial settlement the settled part is indicated.

— :36B: - Quantity of Financial Instrument Previously Settled

PSTT: In case of partial settlement the part that was already settled (only possible in case of "reservation")

— :36B: - Quantity of Financial Instrument Remaining to be Settled

RSTT: In case of partial settlement the part that was not yet settled (only possible in case of "reservation")

— :13B: - SSBI: Securities Sub-balance Identifier

In the case of blockings and reservations the reference number is specified here.

— :98C: - Date/Time

SETT: Indication of settlement date and settlement time.

— :22F: - Partial Settlement Indicator

PAIN: Partial settlement of the instruction. A part remains not settled.

PARC: Partial settlement of the instruction. No more executions will follow.

— :93A: - Balance From/To

Balance From and Balance To must not contain identical codes.

FROM: The sub-balance from which units are transferred.

TOBA: The sub-balance to which units are transferred.

1.4.5.2.3 MT508 Examples

Execution of a Position Blocking

Settlement restriction for blocking 600 units is executed.

The restriction reference number of T2S is T2S123456.

:16R:GENL

:20C::SEME//CSDA111508

:23G:NEWM

:98C::PREP//20140103021010

:16R:LINK

:20C::RELA//111111

:16S:LINK

:16R:LINK

:20C::MITI//T2SREF208

:16S:LINK

:16S:GENL

:16R:INPOSDET

:95P:ACOW//VBOEATWWXXX

:97A::SAFE//OCSD227600

:36B::ESTT//UNIT/600,

:**13B::SSBI//T2S123456**

:35B:ISIN AT0000800800

:98C::SETT//20140103020245

:**93A::FROM//AWAS**

:**93A::TOBA/RT/BLO1**

:16S:INPOSDET

(Partial) Execution of a Position Earmarking

On a securities account there is a position of 90,000 units of a government bond (AT0000A105W3). The settlement restriction instructs 100,000 units to be earmarked. 90,000 units will be earmarked (partial execution). No more executions shall follow this order. No restriction reference number is assigned for earmarkings.

:16R:GENL

:20C::SEME//CSDA333508

:23G:NEWM

:98C::PREP//20150103021010

:16R:LINK

:20C::RELA//33333

:16S:LINK

:16R:LINK

:**20C::MITI//T2SREF333**

:16S:LINK

:16S:GENL

:16R:INPOSDET

:95P:ACOW//VBOEATWWXXX

:97A::SAFE//OCSD227600

:36B::ESTT//UNIT/90000,

:36B::RSTT//UNIT/0,

:35B:ISIN AT0000A105W3

:98C::SETT//20150103020245

:**22F::PARS//PARC**

:**93A::FROM//AWAS**

:**93A::TOBA/RT/EAR1**

:16S:INPOSDET

Execution of an Increase of a Blocked Position

A "blocking" settlement restriction is executed. The restriction reference number is T2S123456.

:16R:GENL

:20C::SEME//CSDA444508
:23G:NEWM
:98C::PREP//20150103021010
:16R:LINK
:20C::RELA//4444
:16S:LINK
:16R:LINK
:20C::MITI//T2SREF4458
:16S:LINK
:16S:GENL
:16R:INPOSDET
:95P:ACOW//VBOEATWWXXX
:97A::SAFE//OCSD227600
:36B::ESTT//UNIT/200,
:13B::SBI//T2S123456
:35B:ISIN AT0000800800
:98C::SETT//20140103020245
:93A::FROM//AWAS
:93A::TOBA/RT/BLO1
:16S:INPOSDET

Execution - Decrease of a Reservation

A reserved position of 500 units DE000LED4000 (RES1 with restriction reference number T2S000111) shall be returned to be a position available without restriction.

:16R:GENL
:20C::SEME//CSDA55508
:23G:NEWM
:98C::PREP//20150103021010
:16R:LINK
:20C::RELA//55555
:16S:LINK
:16R:LINK
:20C::MITI//T2SREF5558
:16S:LINK
:16S:GENL
:16R:INPOSDET
:95P:ACOW//VBOEATWWXXX
:97A::SAFE//OCSD227600
:36B::ESTT//UNIT/500,
:13B::SBI//T2S000111
:35B:ISIN DE000LED4000
:98C::SETT//20141030020245
:93A::FROM/RT/RES1

:93A:TOBA//AWAS

:16S:INPOSDET

1.4.6 Statement of Holdings – MT535

1.4.6.1 MT535 – Statement of Holdings

For OeKB CSD holdings the statement of holding can be provided daily, weekly or monthly. It will be provided for those banks receiving the statement of account via SWIFT.

1.4.6.1.1 Content

M/O	Tag	Field Name	Qualifier	Option	Format	Codes	Description
Mandatory Sequence A General Information							
M	:16R:	Start of Block			16c	GENL	
M	:28E:	Page Number /Continuation Indicator			5n/4!c	LAST	Last page of a statement with more than one page.
						MORE	Intermediate page of a statement which contains additional pages.
						ONLY	Only page of the statement.
M	:20C:	Sender's Reference	SEME		:4!c//16x		Reference assigned by the sender to unambiguously identify the message.
M	:23G:	Function of the Message			4!c/[4!c]	NEWM	New message
O	:98C:	Preparation Date/Time	PREP		:4!c//8!n6!n		Date and time at which the message was prepared.
M	:98A:	Statement Date	STAT		:4!c//8!n		Date at which the statement is based.
M	:22F:	Statement Frequency Indicator	SFRE		:4!c/[8c]/4!c	DAIL	Statement is sent daily.
						WEEK	Statement is sent weekly.

M/O	Tag	Field Name	Qualifier	Option	Format	Codes	Description
						MNTH	Statement is sent monthly.
M	:22F:	Complete/ Updates Indicator	CODE		:4!c/[8c]/4!c	COMP	Statement gives complete information.
M	:22F:	Statement Type	STTY		:4!c/[8c]/4!c	CUST	Statement is a custody statement.
M	:22F:	Statement Basis	STBA		:4!c/[8c]/4!c	SETT	Statement is based on actual settlement date positions.
M	:97A:	Safekeeping Account	SAFE		:4!c//35x		OeKB CSD's securities account number of the customer.
M	:17B:	Activity Flag	ACTI		:4!c//1!a	Y	There are holdings reported in this statement.
						N	There are no holdings reported in this statement.
M	:17B:	Sub- safekeeping Statement	CONS		:4!c//1!a	N	There are no holdings reported in this statement.
M	:16S:	End of Block			16c	GENL	
End of Sequence A General Information							
Optional Repetitive Sequence B Sub-safekeeping account							
M	:16R:	Start of Block			16c	SUBSAFE	
Optional Repetitive Subsequence B1 Financial Instrument							
M	:16R:	Start of Block			16c	FIN	
M	:35B:	Identification of the Financial Instrument			[ISIN1!e12!c]		'ISIN' followed by <Blank> and ISIN Code
O	:90a:	Market Price	MRKT	A	:4!c//4!c/15d	PRCT	Price expressed as a percentage of par.

M/O	Tag	Field Name	Qualifier	Option	Format	Codes	Description
				B	:4!c//4!c/3!a15d	ACTU	Price expressed as an amount of currency per unit or per share.
O	:98A:	Price Quotation Date	PRIC		:4!c//8!n		Date at which the price was evaluated.
M	:93B:	Aggregate Balance	AGGR		:4!c/[8c]/4!c/[N]15d	FAMT UNIT	Total quantity of financial instruments for the referenced holding expressed as face amount (FAMT) or as number of shares (UNIT).
O	:93B:	Available Balance	AVAI		:4!c/[8c]/4!c/[N]15d	FAMT UNIT	Total quantity of financial instruments of the aggregate balance that is available expressed as face amount (FAMT) or as number of shares (UNIT).
O	:93B:	Not Available Balance	NAVL		:4!c/[8c]/4!c/[N]15d	FAMT UNIT	Total quantity of financial instruments of the aggregate balance that is NOT available expressed as face amount (FAMT) or as number of shares (UNIT).
Optional Repetitive Subsequence B1b Sub-balance							
M	:16R:	Start of Block			16c	SUBBAL	
M	:93B:	Sub-balance			:4!c/[8c]/4!c/[N]15d	FAMT	

M/O	Tag	Field Name	Qualifier	Option	Format	Codes	Description
			AWAS/ BLOK/ OTHR			UNIT	AWAS:Balance of financial instruments that are freely available with no specific additional status BLOK: Balance of financial instruments that are blocked or reserved OTHR: Balance of financial instruments that are earmarked (expressed as face amount (FAMT) or as number of shares (UNIT))
O	:94F:	Place of Safekeeping	SAFE		:4!c//4!c/4!a2!a2!c[3!c]	ICSD NCSD CUST	Financial instruments held at an International Central Securities Depository. Financial instruments held at a National Central Securities Depository. Financial instruments held at a local custodian.
O	:70C:	Sub-Balance Details Narrative	SUBB		:4!c//4*35x		Provides additional balance information.
Optional Repetitive Subsequence B1b1 Quantity Breakdown							
M	:16R:	Start of Block			16c	BREAK	
O	:13B:	Sub-balance Identifier	LOTS		:4!c//30x		Lot Number
O	:93B:	Lot Balance	LOTS		:4!c/8c/4!c/[N]15d		Balance of financial instruments that is part of the lot described.

M/O	Tag	Field Name	Qualifier	Option	Format	Codes	Description
M	:16S:	End of Block			16c	BREAK	
End of Subsequence B1b1 Quantity Breakdown							
M	:16S:	End of Block			16c	SUBBAL	
End of Subsequence B1b Sub-balance							
M	:16S:	End of Block			16c	FIN	
End of Subsequence B1 Financial Instrument							
M	:16S:	End of Block			16c	SUBSAFE	
End of Sequence B Sub-safekeeping account							

1.4.6.2 Explanation of the SWIFT Fields

Optional Repetitive Subsequence B1b Sub-balance

— :93B: - Sub-balance Details Narrative

This field is filled with: '/TYPE OF SAFEKEEPING/' followed by type of custody.

— :70C: - Sub-balance Details Narrative

This field is filled with: '/TYPE OF SAFEKEEPING/' followed by type of custody.

Optional Repetitive Subsequence B1b1 Quantity Breakdown

— :13B: - SSBI: Securities Sub-balance Identifier

Sub-balance identifier assigned by T2S.

— :93B: - Lot Balance

Example how the field is filled: LOTS/<Restriction Type>/UNIT/100,

1.4.6.2.1 MT535 Examples

SWIFT MT 535 for securities account number OCSD999900 (with holdings)

:16R:GENL
:28E:1/MORE
:20C::SEME//EA00000000038D30
:23G:NEWM
:98C::PREP//20160510172035
:98A::STAT//20160510
:22F::SFRE//DAIL
:22F::CODE//COMP
:22F::STTY//CUST
:22F::STBA//SETT
:97A::SAFE//OCSD999900

:17B::ACTI//Y
:17B::CONS//N
:16S:GENL
:16R:SUBSAFE
:16R:FIN
:35B:ISIN AT00000FACC2
:90B::MRKT//ACTU/EUR4,8
:98A::PRIC//20160509
:93B::AGGR//UNIT/166,
:93B::AVAI//UNIT/49,
:93B::NAVL//UNIT/117,
:16R:SUBBAL
:93B::AWAS//UNIT/49,
:94F::SAFE//NCSD/OCSDATWWXXX
:70C::SUBB//TYPE OF SAFEKEEPING/GS
:16R:BREAK
:93B::LOTS/AWAS/UNIT/4,
:16S:BREAK
:16S:SUBBAL
:16R:SUBBAL
:93B::BLOK//UNIT/117,
:94F::SAFE//NCSD/OCSDATWWXXX
:70C::SUBB//TYPE OF SAFEKEEPING/GS
:16R:BREAK
:13B::LOTS//1600038585102000
:93B::LOTS/RES1/UNIT/1,
:16S:BREAK
:16R:BREAK
:13B::LOTS//1500029613302000
:93B::LOTS/RES1/UNIT/95,
:16S:BREAK
:16R:BREAK
:13B::LOTS//1500029612902000
:93B::LOTS/BLO1/UNIT/21,
:16S:BREAK
:16S:SUBBAL
:16S:FIN
:16R:FIN
:35B:ISIN AT000B013560
:93B::AGGR//FAMT/760000,
:93B::AVAI//FAMT/760000,
:93B::NAVL//FAMT/0,
:16R:SUBBAL
:93B::AWAS//FAMT/750000,

```
:94F::SAFE//NCSD/OCSDATWWXXX
:70C::SUBB//TYPE OF SAFEKEEPING/GS
:16R::BREAK
:93B::LOTS/AWAS/FAMT/760000,
:16S::BREAK
:16S::SUBBAL
:16S::FIN
:16S::SUBSAFE
```

SWIFT MT 535 nil statement

```
:16R::GENL
:28E:1/ONLY
:20C::SEME//RE09306092206001
:23G::NEWM
:98C::PREP//20151102205853
:98A::STAT//20151102
:22F::SFRE//DAIL
:22F::CODE//COMP
:22F::STTY//CUST
:22F::STBA//SETT
:97A::SAFE//OCSD999900
:17B::ACTI//N
:17B::CONS//N
:16S::GENL
```

1.4.7 Statement of Transactions – MT536

1.4.7.1 MT536 – Statement of Transactions

Information on transactions on OeKB CSD Securities Accounts can be provided daily and ad hoc. It will be provided for those banks receiving the statement of transactions via SWIFT.

These data are sent as SWIFT message type MT536 (Statement of Transactions).

The report makes it possible to carry out automatic reconciliation of the securities account movements as booked in OeKB CSD with the records of the OeKB CSD participant.

1.4.7.1.1 Content

M/O	Tag	Field Name	Qualifier	Option	Format	Codes	Description
Mandatory Sequence A General Information							
M	:16R:	Start of Block			16c	GENL	

M/O	Tag	Field Name	Qualifier	Option	Format	Codes	Description
M	:28E:	Page Number /Continuation Indicator			5n/4!c	LAST	Last page of a statement with more than one page.
						MORE	Intermediate page of a statement which contains additional pages.
						ONLY	Only page of the statement.
M	:20C:	Sender's Message Reference	SEME		:4!c//16x		Reference assigned by the sender to unambiguously identify the message.
M	:23G:	Function of the Message			4!c/[4!c]	NEWM	New message
M	:98C:	Preparation Date/Time	PREP		:4!c//8!n6!n		Date and time at which the message was prepared.
M	:69A:	Statement Period			:4!c//8!n/8!n	STAT	Period on which the statement is reporting.
O	:22F:	Statement Frequency Indicator	SFRE		:4!c/[8c]/4!c	DAIL	Statement is sent daily.
						ADHO	Statement is sent following a request by the receiver.
O	:22F:	Complete/ Updates Indicator	CODE		:4!c/[8c]/4!c	COMP	Statement gives complete information.
M	:22F:	Statement Basis	STBA		:4!c/[8c]/4!c	SETT	Statement is based on actual settlement date positions.
M	:97A:	Safekeeping Account	SAFE		:4!c//35x		OeKB CSD's securities account number of the customer.
M	:17B:	Activity Flag	ACTI		:4!c//1!a	Y	There are transactions reported in this statement.

M/O	Tag	Field Name	Qualifier	Option	Format	Codes	Description
						N	There are no transactions reported in this statement.
M	:17B:	Sub-safekeeping Statement Flag	CONS		:4!c//1!a	Y	This report includes transactions at sub-account level.
						N	This report doesn't include transactions at sub-account level.
M	:16S:	End of Block			16c	GENL	

End of Sequence A General Information

Optional Repetitive Sequence B Sub-safekeeping Account

M	:16R:	Start of Block			16c	SUBSAFE	
---	-------	----------------	--	--	-----	---------	--

Optional Repetitive Subsequence B1 Financial Instrument

M	:16R:	Start of Block			16c	FIN	
M	:35B:	Identification of the Financial Instrument			[!SIN1!e12!c]		'ISIN' followed by <Blank> and ISIN Code
O	:93B:	First Opening Balance	FIOP		:4!c//4!c/[N]15d	FAMT	Initial holding at the beginning of the statement period expressed as face value.
						UNIT	Initial holding at the beginning of the statement period expressed as number of shares.
O	:93B:	Final Closing Balance	FICL		:4!c//4!c/[N]15d	FAMT	Final holding at the end of the statement period expressed as face value.
						UNIT	Initial holding at the end of the statement period expressed as number of shares.

Mandatory Repetitive Subsequence B1a Transaction

M	:16R:	Start of Block			16c	TRAN	
---	-------	----------------	--	--	-----	------	--

M/O	Tag	Field Name	Qualifier	Option	Format	Codes	Description
Mandatory Repetitive Subsequence B1a1 Linkages							
M	:16R:	Start of Block			16c	LINK	
M	:20C:	Related Message Reference			:4!c//16x	RELA	Customer reference or OeKB CSD reference of the instruction.
End of Subsequence B1a1 Linkages							
Optional Subsequence B1a2 Transaction Details							
M	:16R:	Start of Block			16c	TRANSDT	
M	:36B:	Posting Quantity	PSTA		:4!c//4!c/15d	FAMT	Quantity of financial instrument posted to the safekeeping account expressed as face amount.
						UNIT	Quantity of financial instrument posted to the safekeeping account expressed as amount of shares.
O	:19A:	Posting Amount	PSTA		4!c//[N]3!a15d		Settlement amount of the transaction, ISO currency code followed by cash value.
M	:22F:	Transaction Indicator	TRAN		:4!c/[8c]/4!c	SETT	The transaction relates to settlement and clearing.
						CORP	The transaction relates to corporate action.
M	:22H:	Receive/Deliver Indicator	REDE		:4!c//4!c	DELI	The transaction is a delivery.
						RECE	The transaction is a receipt.
M	:22H:	Payment Indicator	PAYM		:4!c//4!c	APMT	The transaction is versus payment.
						FREE	The transaction is free of payment.
O	:22F:	CCP Eligibility Indicator	CCPT		:4!c//4!c	YCCP	The transaction was initiated by CCP.A.

M/O	Tag	Field Name	Qualifier	Option	Format	Codes	Description
O	:98C:	Acknowledged Status Timestamp	ASTS		:4!c//8!n6!n		The timestamp of acceptance or acknowledgement of the instruction by the account servicer.
M	:98A:	Effective Settlement Date	ESET		:4!c//8!n		Date at which a transaction effectively settled.
O	:98C:	Matched Status Timestamp	MTCH		:4!c//8!n6!n		The timestamp of matching of the instruction by the account servicer.
O	:25D:	Movement Status	MOVE		:4!c/[8c]/4!c	REVE	Reversal of a previously reported transaction.
O	:22F:	Beneficial Ownership Indicator	BENE		:4!c/[8c]/4!c	NBEN YBEN	No Change of Beneficial Ownership (NCBO) Change of Beneficial Ownership (CBO)
Optional Repetitive Subsequence B1a2a Settlement Parties							
M	:16R:	Start of Block			16c	SETPRTY	
M	:95P:	Party	DEAG REAG		4!c//4!a2!a2!c[3!c]		BIC of Receiving/Delivering party that interacts with the place of settlement.
M	:16S:	End of Block			16c	SETPRTY	
End of Subsequence B1a2a Settlement Parties							
M	:16S:	End of Block			16c	TRANSDET	
End of Subsequence B1a2 Transaction Details							
M	:16S:	End of Block			16c	TRAN	
End of Subsequence B1a Transaction							
M	:16S:	End of Block			16c	FIN	
End of Subsequence B1 Financial Instrument							
M	:16S:	End of Block			16c	SUBSAFE	

M/O	Tag	Field Name	Qualifier	Option	Format	Codes	Description
		End of Sequence B Sub-safekeeping account					

1.4.7.1.2 Explanation of the SWIFT Fields

Differentiation of Instruction types in MT536

With T2S there will be in addition to the existing instruction types (DVP, RVP, DFP und RFP) four additional types: DWP, RWP, PFDC and PFDD. In the MT536 message the instruction type cannot be provided explicitly. Instead it can be derived from the contents of the following fields in subsequence B1a2. The sign in :19A::SETT is set according to the sign of the corresponding MT instruction (MT541-MT543).

- :22H::REDE (Receive Deliver Indicator)
- :22H::PAYM (Payment Indicator)
- :19A::PSTA (Posting Amount)
- :36B::PSTA (Posting Quantity)

	:22H::REDE	:22H::PAYM	:19A::PSTA	:36B::PSTA
DVP	DELI	APMT	+	+
RVP	RECE	APMT	+	+
DFP	DELI	FREE	n.a	+
RFP	RECE	FREE	n.a.	+
DWP	DELI	APMT	-	+
RWP	RECE	APMT	-	+
PFDC	DELI	APMT	+	0
PFDD	DELI	APMT	-	0
PFRC	RECE	APMT	-	0
PFRD	RECE	APMT	+	0

1.4.7.1.3 MT536 Examples

SWIFT MT536 for securities account number OCSD999900 with securities transactions

:16R:GENL
:28E:1/ONLY
:20C::SEME//TR09343094590002
:23G:NEWM
:98C::PREP//20151201200127
:69A::STAT//20151201/20151201
:22F::SFRE//ADHO
:22F::CODE//COMP
:22F::STBA//SETT

:97A::SAFE//OCSD999900

:17B::ACTI//Y

:17B::CONS//N

:16S:GENL

:16R:SUBSAFE

:16R:FIN

:35B::ISIN AT0000612601

:93B::FIOP//UNIT/249,

:93B::FICL//UNIT/0,

:16R:TRAN

:16R:LINK

:20C::RELA//278569951

:16S:LINK

:16R:TRANSDET

:36B::PSTA//UNIT/250,

:19A::PSTA//EUR6134,87

:22F::TRAN//SETT

:22H::REDE//DELI

:22H::PAYM//APMT

:98C::ASTS//20151201090000

:98A::ESET//20151201

:98C::MTCH//20151201090002

:16R:SETPRTY

:95P::REAG//GIBAATWWXXX

:16S:SETPRTY

:16S:TRANSDET

:16S:TRAN

:16R:TRAN

:16R:LINK

:20C::RELA//278569952

:16S:LINK

:16R:TRANSDET

:36B::PSTA//UNIT/1000,

:22F::TRAN//SETT

:22H::REDE//RECE

:22H::PAYM//FREE

:98C::ASTS//20151201090500

:98A::ESET//20151201

:98C::MTCH//20151201105959

:16R:SETPRTY

:95P::DEAG//BKAUATWWXXX

:16S:SETPRTY

:16S:TRANSDET

:16S:TRAN

:16R:TRAN
:16R:LINK
:20C::RELA//09J87076
:16S:LINK
:16R:TRANSDET
:36B::PSTA//UNIT/999,
:22F::TRAN//SETT
:22H::REDE//DELI
:22H::PAYM//FREE
:22F::CCPT//YCCP
:98C::ASTS//20151201102035
:98A::ESET//20151201
:98C::MTCH//20151201104017
:16R:SETPRTY
:95P::DEAG// BKAUATWWXXX
:16S:SETPRTY
:16S:TRANSDET
:16S:TRAN
:16S:FIN
:16R:FIN
:35B::ISIN AT0000606306
:93B::FIOP//UNIT/0,
:93B::FICL//UNIT/0,
:16R:TRAN
:16R:LINK
:20C::RELA//09J87075
:16S:LINK
:16R:TRANSDET
:36B::PSTA//UNIT/416,
:22F::TRAN//SETT
:22H::REDE//RECE
:22H::PAYM//FREE
:22F::CCPT//YCCP
:98C::ASTS//20151201135119
:98A::ESET//20151201
:98C::MTCH//20151201135120
:16R:SETPRTY
:95P::DEAG// BKAUATWWXXX
:16S:SETPRTY
:16S:TRANSDET
:16S:TRAN
:16R:TRAN
:16R:LINK
:20C::RELA//882573305

:16S:LINK

:16R:TRANSDET

:36B::PSTA//UNIT/416,

:19A::PSTA//EUR18154,82

:22F::TRAN//SETT

:22H::REDE//DELI

:22H::PAYM//APMT

:98C::ASTS//20151130140220

:98A::ESET//20151201

:98C::MTCH//20151201094702

:16R:SETPRTY

:95P::DEAG// BKAUATWWXXX

:16S:SETPRTY

:16S:TRANSDET

:16S:TRAN

:16S:FIN

:16R:FIN

:35B:ISIN AT0000908504

:93B::FIOP//UNIT/0,

:93B::FICL//UNIT/0,

:16R:TRAN

:16R:LINK

:20C::RELA//09J87085

:16S:LINK

:16R:TRANSDET

:36B::PSTA//UNIT/1018,

:22F::TRAN//SETT

:22H::REDE//RECE

:22H::PAYM//FREE

:22F::CCPT//YCCP

:98C::ASTS//20151127091053

:98A::ESET//20151201

:98C::MTCH//20151130074532

:16R:SETPRTY

:95P::DEAG// BKAUATWWXXX

:16S:SETPRTY

:16S:TRANSDET

:16S:TRAN

:16R:TRAN

:16R:LINK

:20C::RELA//2576610

:16S:LINK

:16R:TRANSDET

:36B::PSTA//UNIT/433,

:19A::PSTA//EUR15801,28
:22F::TRAN//SETT
:22H::REDE//DELI
:22H::PAYM//APMT
:98C::ASTS//20151126130025
:98A::ESET//20151201
:98C::MTCH//20151127091432
:16R:SETPRTY
:95P::DEAG// BKAUATWWXXX
:16S:SETPRTY
:16S:TRANSDET
:16S:TRAN
:16R:TRAN
:16R:LINK
:20C::RELA//123456
:16S:LINK
:16R:TRANSDET
:36B::PSTA//UNIT/585,
:22F::TRAN//SETT
:22H::REDE//DELI
:22H::PAYM//FREE
:98C::ASTS//20151126131125
:98A::ESET//20151201
:98C::MTCH//20151201091432
:16R:SETPRTY
:95P::DEAG// BKAUATWWXXX
:16S:SETPRTY
:16S:TRANSDET
:16S:TRAN
:16S:FIN
:16R:FIN
:35B:ISIN DE000LED4000
:93B::FIOP//UNIT/0,
:93B::FICL//UNIT/0,
:16R:TRAN
:16R:LINK
:20C::RELA//+09J87085
:16S:LINK
:16R:TRANSDET
:36B::PSTA//UNIT/1018,
:22F::TRAN//SETT
:22H::REDE//RECE
:22H::PAYM//FREE
:98C::ASTS//20151127131025

:98A::ESET//20151201

:98C::MTCH//20151127131026

:16R:SETPRTY

:95P::DEAG//DAKVDEFFXXX

:16S:SETPRTY

:16S:TRANSDDET

:16S:TRAN

:16S:FIN

:16S:SUBSAFE

SWIFT MT536 nil statement for securities account number OCSD999900 (no transactions)

:16R:GENL

:28E:1/ONLY

:20C::SEME//TR09354094593001

:23G:NEWM

:98C::PREP//20151202214300

:69A::STAT//20051202/20151202

:22F::SFRE//ADHO

:22F::CODE//COMP

:22F::STBA//SETT

:97A::SAFE//OCSD999900

:17B::ACT//N

:17B::CONS//N

:16S:GENL

1.4.8 Penalty Report - MT537

In the framework of a settlement penalties regime, the message can be sent by a market infrastructure or an account servicer to an account owner or its designated agent to provide the details of the penalties calculated on instructions that matched or settled late. In this case, the instructions referred to in the report may no longer be pending at the moment of reporting.

1.4.8.1 MT537 – Daily Penalty Report

This report contains details of all NEW penalties calculated on instructions that matched late or failed to settle on the previous business day. One MT537 is sent for penalties related to Intra and Cross instructions and a separate MT537 is sent for penalties related to external instructions. In case there are no NEW penalties to report a message with activity flag set to N will be sent.

It is only in this report that details of the underlying transactions are reported.

1.4.8.1.1 Content

M/O	Tag	Field Name	Qualifier	Option	Format	Codes	Description
Mandatory Sequence A General Information							
M	:16R:	Start of Block			16c	GENL	
M	:28E:	Page Number /Continuation Indicator			5n/4!c	LAST MORE ONLY	Last page of a statement with more than one page. Intermediate page of a statement which contains additional pages. Only page of the statement.
M	:20C:	Sender's Message Reference	SEME		:4!c//16x		Reference assigned by the sender to unambiguously identify the message.
M	:23G:	Function of the Message	PENA		4!c/[4!c]		Penalty Fees
M	:98A:	Statement Date	STAT		:4!c//8!n		Date at which the statement is based.
M	:98C:	Preparation Date/Time	PREP		:4!c//8!n6!n		Date and time at which the message was prepared.
M	:22F:	Statement Frequency Indicator	SFRE		:4!c/[8c]/4!c	DAIL	Statement is sent daily.
M	:22H:	Statement Structure Type Indicator	STST		:4!c//4!c	PENA	Statement contains penalties.
M	:95P:	Account Owner	ACOW		:4!c//4!a2!a2!c[3!c]		Account Owner

M/O	Tag	Field Name	Qualifier	Option	Format	Codes	Description
M	:97A:	Safekeeping Account	SAFE		:4!c//35x		MT537 PENA applies to a customer and not a particular safekeeping account. This field will be filled with the value NONREF
M	:17B:	Activity Flag	ACTI		:4!c//1!a	Y	There are penalties reported in this statement.
						N	There are no penalties reported in this statement.
M	:16S:	End of Block			16c	GENL	
End of Sequence A General Information							
Optional Repetitive Sequence D Penalties							
M	:16R:	Start of Block			16c	PENA	
M	:69A:	Period			:4!c//8!n/8!n	STAT	Period on which the statement is reporting. (Date1 = Date 2)
M	:22F:	Complete/ Updates Indicator	CODE		:4!c//[8c]/4!c	FWIS	Daily New Penalty List
M	:95P:	Account Servicer/Depository	ASDP		:4!c//4!a2!a2!c[3!c]	OCSDAT WWXXX	BIC of Account Servicer
Optional Repetitive Subsequence D1 Penalties per Currency for a Party							
M	:16R:	Start of Block			16c	PENAC UR	
M	:11A:	Currency	PECU		:4!c//3!a		Currency of Penalties

M/O	Tag	Field Name	Qualifier	Option	Format	Codes	Description
M	:98A:	Computation Date	DACO		:4!c//8!n		Penalty Detection date/time It is the day for which the penalty was computed. It is: - The date on which the instruction matched for LMFP. -The date on which an instruction fails to settle for SEFP. Note: This date is not updated upon re-calculation of the penalty and always relates to the business day for which the penalty was initially computed.
M	:95P:	Related Party	REPA		:4!c//4!a2!a2!c[3!c]		Identification of the party reported as party imposed with the penalties reported or party credited with the penalty(ies).
M	:95P:	Counterparty's Account Servicer/Depository	CASD		:4!c//4!a2!a2!c[3!c]		Party that services the account of the counterparty to the party reported as Related Party.
M	:22F:	Party Capacity Indicator (Party Type of Party)	TRCA		:4!c/[8c]/4!c	NCSD CCPA CSDP EXTE	CSD CCP Participants of CSD External CSD
Optional Repetitive Subsequence D1a Penalties per Counterparty							
M	:16R:	Start of Block				PENAC OUNT	
M	:95P:	Related Party	REPA		:4!c//4!a2!a2!c[3!c]		Counterparty
M	:22F:	Party Capacity Indicator	TRCA		:4!c/[8c]/4!c	NCSD CCPA CSDP	CSD CCP Participants of CSD

M/O	Tag	Field Name	Qualifier	Option	Format	Codes	Description
		(Party Type of Party)				EXTE	External CSD
M	:19A:	Bilateral Net Amount	AGNT		:4!c//[N]3!a15d		Daily net for a party vs counterparty
Optional Repetitive Subsequence D1a1 Penalty Details							
M	:16R:	Start of Block			16c	PENDET	
O	:20C:	Penalty Reference	PREF		:4!c//16x		individual identification of the penalty
M	:20C:	Penalty Common Reference	PCOM		:4!c//16x		Common Reference of the penalty for both the failing and the non-failing parties
O	:20C:	Previous Penalty Common Reference	PPCM		:4!c//16x		Previous common identification of the penalty (following reallocation)
O	:20C:	Previous Penalty Reference	PPRF		:4!c//16x		Previous individual identification of the penalty (following reallocation)
M	:22H:	Penalty Type	PNTP		:4!c//4!c	SEFP	Settlement Fail Penalty
						LMFP	Late Matching Fail penalty
M	:22H:	Calculation Method	CALM		:4!c//4!c	BOTH	Sum of Penalties Based on Securities and Cash
						CASH	Penalty Based on Cash
						MIXE	Penalty Based on the Discount Rate
						SECU	Penalty Based on Securities

M/O	Tag	Field Name	Qualifier	Option	Format	Codes	Description
O	:17B:	Amount Considered For Aggregation Flag	CMPU		:4!c//1!a	Y	Indicates whether or not the amount calculated for the reported penalty will be added to the aggregated amounts at global level.
						N	
O	:25D:	Penalty Status	PNST		:4!c/[8c]/4!c	ACTV	Penalty active
						REMO	Penalty removed

[Optional Repetitive field](#)

O	:24B:	Reason Code	ACTV			OTHR	Other
						RALO	Reallocation
						SWIC	Switch
						UPDT	Update
			REMO			OTHR	Other
						RALO	Reallocation
						SEMP	Paym Syst closed
						SWIC	Switch
						INSO	Insolvency
						SESU	Settmt suspended
						SUSP	Trading susp.
						TEIM	Technical reasons
O	:70D:	Status Narrative	REAS		:4!c//6*35x		additional description of REMO/OTHR or REMO/SWIC
M	:19A:	Amount Computed	AMCO		:4!c//[N]3!a15d		Amount computed for the penalty
M	:99A:	Number Days	DAAC		:4!c//[N]3!n		For Settlement Fail =1. For Late Matching Fail = no. of business days since ISD.

[Optional Repetitive Subsequence D1a1A Calculation Details](#)

M	:16R:	Start of Block			16c	CALDET	
---	-------	----------------	--	--	-----	--------	--

M/O	Tag	Field Name	Qualifier	Option	Format	Codes	Description
M	:98A:	Penalty Date/Time	PEDA		:4!c//8!n		Date/time on which the penalty is calculated.
O	:17B:	Missing Reference Data Flag	MRED		:4!c//1!a	Y	reference data needed for penalty calculation is missing
						N	reference data needed for penalty calculation is not missing

Optional Repetitive Subsequence D1a1A1 Financial Instrument Attributes

M	:16R:	Start of Block				FIA	
M	:35B:	Identification of the Financial Instrument			ISIN1!e12!c		ISIN
O	:12A:	Type of Financial Instrument	CLAS		:4!c/REGL/30x	SHRS SOVR DEBT SECU ETFS UCIT MMKT EMAL OTHR	security type code as defined in the CSD Regulation
O	:17B:	Liquidity Flag	LIQU		:4!c//1!a	Y N	Field present only if liquidity/illiquidity relevant for penalty calculation
O	:17B:	Security subject to penalties Flag	OKPE		:4!c//1!a	Y N	If this field is the security is subject to penalties
O	:17B:		SMEM		:4!c//1!a	Y	

M/O	Tag	Field Name	Qualifier	Option	Format	Codes	Description
		SME Growth Market Flag				N	Field present only if „traded on SME growth market“ relevant for penalty calculation.
O	:94B:	Place of Trade	TRAD		:4!c/[8c]/4!c/30x]	EXCH	Present if both instructions have same MIC in place of Trade
O	:92B:	Exchange Rate 1	EXCH		:4!c//3!a/3!a/15d		The first Ccy is the Unit Ccy, the second Ccy is the quoted Ccy
O	:92B:	Exchange Rate 2	EXCH		:4!c//3!a/3!a/15d		The first Ccy is the Unit Ccy, the second Ccy is the quoted Ccy
O	:92A:	Penalty Rate	CBON GBON GOMB ILSH LISH NBON OTHR		:4!c//[N]15d		Corporate Bonds SME Growth Market (non-Bonds) Government and Municipal Bonds Illiquid Shares Liquid Shares SME Growth Market Bonds Other Financial Instruments
M	:16S:	End of Block				FIA	
End of Subsequence D1a1A1 Financial Instrument Attributes							
O	:92A:	Penalty Discount Rate	PDRA		:4!c//[N]15d		discount rate of the relevant currency
O	:19A:	Penalty Sub Amount Cash	CASH		:4!c//[N]3!a15d		
O	:19A:	Penalty Sub Amount Securities	SECU		:4!c//[N]3!a15d		
M	:16S:	End of Block				CALDET	

M/O	Tag	Field Name	Qualifier	Option	Format	Codes	Description
End of Optional Repetitive Subsequence D1a1A Calculation Details							
Optional Subsequence D1a1B Related Transaction							
M	:16R:	Start of Block				RELTRAN	
M	:20C:	Account Owner Reference	ACOW		:4!c//16x		Account Owner Reference: Settlement Instruction
O	:20C:	Other References	ASRF		:4!c//16x		Account Servicer Reference
			PCTI				Third party Reference
			MITI				T2S Reference
			COMM				Common Reference
			CORP				Corporate Action Event Id
			RELA				Matching Reference
Optional Subsequence D1a1B1 Transaction Details							
M	:16R:	Start of Block				TRAN	
M	:22H:	Receive/Deliver Indicator	REDE		:4!c//4!c	DELI	Deliver
						RECE	Receive
M	:22H:	Payment Indicator	PAYM		:4!c//4!c	APMT	Against payment
						FREE	Free of payment
M	:22F:	Type of Settlement Transaction Indicator	SETR		:4!c/[8c]/4!c	/T2S/AUTO	Autocollateral
						/T2S/CORP	Corporate Action
						/T2s/REBL	Rebalancing
						BSBK	Meaning of Codes without data source scheme (here = /T2S/) can be found in the SWIFT SR2020 docu
						BYIY	
						CLAI	
						CNCB	
						COLI	
COLO							

M/O	Tag	Field Name	Qualifier	Option	Format	Codes	Description
						CONV	
						ETFT	
						FCTA	
						INSP	
						NETT	
						NSYN	
						OWNE	
						OWNI	
						PAIR	
						PLAC	
						PORT	
						REDI	
						REDM	
						RELE	
						REPU	
						RODE	
						RVPO	
						SBBK	
						SBRE	
						SECB	
						SECL	
						SECL	
						SLRE	
						SUBS	
						SWIF	
						SWIT	
						SYND	
						TBAC	
						TRAD	
						TRPO	
						TRVO	
						TURN	

M/O	Tag	Field Name	Qualifier	Option	Format	Codes	Description
M	:22F:	Transaction Indicator	TRAN		:4!c/[8c]/4!c	SETT CORP	
O	:22F:	Business Day Event	BDEV		:4!c/[8c]/4!c	EDVP EDFP	Verus Payment Cut-Off Free of Payment Cut-Off
M	:98C:	Acknowledged Status Timestamp	ASTS		:4!c//8!n6!n		
O	:98C:	Cut-Off Timestamp	CUTS		:4!c//8!n6!n		
M	:98C:	Matched Status Timestamp	MTCH		:4!c//8!n6!n		
O	:98C:	Scheduled Cut-Off Timestamp	SCTS		:4!c//8!n6!n		
M	:98A:	Settlement Date	SETT		:4!c//8!n		Intended Settlement Date of Instruction
M	:97A:	Safekeeping Account	SAFE		:4!c//35x		
O	:97A:	Cash Account	CASH		:4!c//35x		
O	:95P:	Safekeeping Account Owner	ACOW		:4!c//4!a2!a2!c[3!c]		
O	:95P:	Cash Account Owner	CACO		:4!c//4!a2!a2!c[3!c]		
M	:36B:	Posting Quantity of Financial Instrument	PSTA		:4!c//4!c/15d	FAMT UNIT	Face Amount Unit
O	:19A:	Posting Amount	PSTA		:4!c//[N]3!a15d		
Optional Repetitive Subsequence D1a1B1a Status (This subsequence is used only in case of Settlement Status Failing)							
M	:16R:	Start of Block				STAT	

M/O	Tag	Field Name	Qualifier	Option	Format	Codes	Description
M	:25D:	Status Code	SETT		:4!c/[8c]/4!c	PENF	Settlement Status Failing
optional Repetitive subsequence D1a1B1a1 Reason							
M	:16R:	Start of Block				REAS	
M	:24B:	Pending/Failing Reason	PENF		:4!c/[8c]/4!c	BLOC CDLR CLAC CMON CSDH CVAL CYCL INBC LACK LATE LINK MONY OTHR PART PRCY PREA PRSY SBLO	For description of Codes see SWIFT SR2020
O	:70D:	Reason Narrative	REAS		:4!c//6*35x		
M	:16S:	End of Block			16c	REAS	
End of optional Repetitive subsequence D1a1b1a1 Reason							
M	:16S:	End of Block			16c	STAT	
End of optional Repetitive subsequence D1a1B1a Status							
M	:16S:	End of Block			16c	TRAN	
End of optional Subsequence D1a1B1 Transaction Details							
M	:16S:	End of Block			16c	RELTRAN	
End of optional Subsequence D1a1B Related Transactions							
M	:16S:	End of Block			16c	PENDET	

M/O	Tag	Field Name	Qualifier	Option	Format	Codes	Description
End optional Repetitive subsequence D1a1 Penalty Details							
M	:16S:	End of Block			16c	PENAC OUNT	
End optional Repetitive subsequence D1a Penalties per Counterparty							
M	:16S:	End of Block			16c	PENAC UR	
End optional Repetitive subsequence D1 Penalties per Currency for a Party							
M	:16S:	End of Block			16c	PENA	
End optional Repetitive subsequence D Penalties							

1.4.8.1.2 MT537 Daily New Examples

No new penalties to report

There are no new penalties to report for participant PRTAATWWXXX

:16R:GENL
:28E:1/ONLY
:20C::SEME//DAILYLISTEX0100
:23G:PENA
:98A::STAT//20200622
:98C::PREP//20200622/120000
:22F::SFRE//DAIL
:22H::STST//PENA
:95P::ACOW// PRTAATWWXXX
:97A::SAFE//NONREF
:17B::ACTI//N
:16S:GENL

New penalties to report

There are 3 new penalties to report for participant PRTAATWWXXX.

There are two settlement failure penalties where the counterparty is PRTBATWWXXX (also a participant of OCSDATWWXXX). Since one is a credit and one a debit for the same amount the aggregate amount reported in :19A::AGNT is 0.

For the 3rd penalty, also a settlement failure, the counterparty is PRTZESMMXXX (a participant of CSD CSDZBIC1XXX).

:16R:GENL
:28E:1/ONLY
:20C::SEME//DAILYLISTEX0100
:23G:PENA

:98A::STAT//20190624
:98C::PREP//20190624120000
:22F::SFRE//DAIL
:22H::STST//PENA
:95P::ACOW// PRTAATWWXXX
:97A::SAFE//NONREF
:17B::ACTI//Y
:16S::GENL
:16R::PENA
:69A::STAT//20190621/20190621
:22F::CODE//FWIS
:95P::ASDP//OCSDATWWXXX
:16R::PENACUR
:11A::PECU//EUR
:98A::DACO//20190621
:95P::REPA//PRTAATWWXXX
:95P::CASD//OCSDATWWXXX
:22F::TRCA//CSDP
:16R::PENACOUNT
:95P::REPA//PRTBATWWXXX
:22F::TRCA//CSDP
:19A::AGNT//EURO,
:16R::PENDET
:20C::PREF//F201906210000001
:20C::PCOM//201906210000001
:22H::PNTP//SEFP
:22H::CALM//SECU
:22H::PNST//ACTV
:19A::AMCO//NEUR25,
:99A::DAAC//001
:16R::CALDET
:98A::PEDA//20190621
:16R::FIA
:35B::ISIN ISIN00000001
:12A::CLAS//REGL//SHRS
:17B::LIQU//N
:17B::SMEM//Y
:94B::TRAD//EXCH//ABCD
:92A::GBON//0,0025
:16S::FIA
:16S::CALDET
:16R::RELTRAN
:20C::ACOW//PARTICIPANT-A001
:20C::MITI//T2S1000000000001

:20C::COMM//T2S00000000000001
:16R:TRAN
:22H::REDE//DELI
:22H::PAYM//APMT
:22F::SETR//TRAD
:22F::TRAN//SETT
:22F::BDEV//EDVP
:98C::ASTS//20190621133000
:98C::CUTS//20190621160145
:98C::MTCH//20190621133015
:98C::SCTS//20190621160000
:98A::SETT//20190621
:97A::SAFE//1000000123
:97A::CASH//2000000123
:95P::ACOW//PRTAATWWXXX
:95P::CACO//PRTAATWWXXX
:36B::PSTA//UNIT/100000,
:19A::PSTA//EUR750000,
:16R:STAT
:25D::SETT//PENF
:16R:REAS
:24B::PENF//PREA
:70D::REAS//Instruction failed because Particip
ant A had it on hold
:16S:REAS
:16S:STAT
:16S:TRAN
:16S:RELTRAN
:16S:PENDET
:16R:PENDET
:20C::PREF//N201906210000002
:20C::PCOM//201906210000002
:22H::PNTP//SEFP
:22H::CALM//SECU
:22H::PNST//ACTV
:19A::AMCO//EUR25,
:99A::DAAC//001
:16R:CALDET
:98A::PEDA//20190621
:16R:FIA
:35B:ISIN ISIN00000001
:12A::CLAS/REGL/SHRS
:17B::LIQU//N
:17B::SMEM//Y

:94B::TRAD//EXCH/ABCD
:92A::GBON//0,0025
:16S:FIA
:16S:CALDET
:16R:RELTRAN
:20C::ACOW//PARTICIPANT-A002
:20C::MITI//T2S20000000000002
:20C::COMM//T2S00000000000002
:16R:TRAN
:22H::REDE//RECE
:22H::PAYM//APMT
:22F::SETR//TRAD
:22F::TRAN//SETT
:22F::BDEV//EDVP
:98C::ASTS//20190621143000
:98C::CUTS//20190621160145
:98C::MTCH//20190621143015
:98C::SCTS//20190621160000
:98A::SETT//20190621
:97A::SAFE//1000000123
:97A::CASH//2000000123
:95P::ACOW//PRTAATWWXXX
:95P::CACO//PRTAATWWXXX
:36B::PSTA//UNIT/100000,
:19A::PSTA//NEUR800000,
:16R:STAT
:25D::SETT//PENF
:16R:REAS
:24B::PENF//CLAC
:70D::REAS//Instruction failed because Particip
ant B has insufficient securities to settle
:16S:REAS
:16S:STAT
:16S:TRAN
:16S:RELTRAN
:16S:PENDET
:16S:PENACOUNT
:16S:PENACUR
:16R:PENACUR
:11A::PECU//EUR
:98A::DACO//20190621
:95P::REPA//PRTAATWWXXX
:95P::CASD//CSDZBIC1XXX
:22F::TRCA//CSDP

:16R:PENACOUNT
:95P::REPA//PRTZESMMXXX
:22F::TRCA//CSDP
:19A::AGNT//NEUR5,42
:16R:PENDET
:20C::PREF//F201906210000003
:20C::PCOM//201906210000003
:22H::PNTP//SEFP
:22H::CALM//CASH
:22H::PNST//ACTV
:19A::AMCO//NEUR5,42
:99A::DAAC//001
:16R:CALDET
:98A::PEDA//20190621
:16R:FIA
:35B::ISIN ISIN000000009
:12A::CLAS/REGL/SHRS
:17B::LIQU//N
:16S:FIA
:92A::PDRA//0,0006027397
:16S:CALDET
:16R:RELTRAN
:20C::ACOW//PARTICIPANT-A003
:20C::MITI//T2S10000000000003
:20C::COMM//T2S00000000000003
:16R:TRAN
:22H::REDE//RECE
:22H::PAYM//APMT
:22F::SETR//TRAD
:22F::TRAN//SETT
:22F::BDEV//EDVP
:98C::ASTS//20190621153000
:98C::CUTS//20190621160145
:98C::MTCH//20190621153015
:98C::SCTS//20190621160000
:98A::SETT//20190621
:97A::SAFE//1000000123
:97A::CASH//2000000123
:95P::ACOW//PRTAATWWXXX
:95P::CACO//PRTAATWWXXX
:36B::PSTA//UNIT/0,
:19A::PSTA//NEUR900000,
:16R:STAT
:25D::SETT//PENF

:16R:REAS
:24B::PENF//MONY
:70D::REAS//Instruction failed because Particip
ant A has insufficient cash to sett
le
:16S:REAS
:16S:STAT
:16S:TRAN
:16S:RELTRAN
:16S:PENDET
:16S:PENACOUNT
:16S:PENACUR
:16S:PENA

1.4.8.2 MT537 – Daily Modified Penalty Report

This daily report contains details of all *modified* penalties calculated on instructions that matched late or failed to settle from the beginning of the penalty period. One MT537 is sent for penalties related to Intra and Cross instructions and a separate MT537 is sent for penalties related to external instructions. In case there are no modified penalties to report NO message will be sent.

This report contains no details of the underlying transactions (only the relevant transaction references).

1.4.8.2.1 Content

M/O	Tag	Field Name	Qualifier	Option	Format	Codes	Description
Mandatory Sequence A General Information							
M	:16R:	Start of Block			16c	GENL	
M	:28E:	Page Number /Continuation Indicator			5n/4!c	LAST MORE ONLY	Last page of a statement with more than one page. Intermediate page of a statement which contains additional pages. Only page of the statement.
M	:20C:	Sender's Message Reference	SEME		:4!c//16x		Reference assigned by the sender to unambiguously identify the message.
M	:23G:	Function of the Message	PENA		4!c/[4!c]		Penalty Fees

M/O	Tag	Field Name	Qualifier	Option	Format	Codes	Description
M	:98A:	Statement Date	STAT		:4!c//8!n		Date at which the statement is based.
M	:98C:	Preparation Date/Time	PREP		:4!c//8!n6!n		Date and time at which the message was prepared.
M	:22F:	Statement Frequency Indicator	SFRE		:4!c//[8c]/4!c	DAIL	Statement is sent daily.
M	:22H:	Statement Structure Type Indicator	STST		:4!c//4!c	PENA	Statement contains penalties.
M	:95P:	Account Owner	ACOW		:4!c//4!a2!a2!c [3!c]		Account Owner
M	:97A:	Safekeeping Account	SAFE		:4!c//35x		MT537 PENA applies to a customer and not a particular safekeeping account. This field will be filled with the value NONREF.
M	:17B:	Activity Flag	ACTI		:4!c//1!a	Y	There are penalties reported in this statement.
						N	There are no penalties reported in this statement.
M	:16S:	End of Block			16c	GENL	

End of Sequence A General Information

Optional Repetitive Sequence D Penalties

M	:16R:	Start of Block			16c	PENA	
M	:69A:	Period			:4!c//8!n/8!n	STAT	Period on which the statement is reporting. (Date1 <= Date 2)
M	:22F:	Complete/ Updates Indicator	CODE		:4!c//[8c]/4!c	FWAM	Daily Modified Penalty List
M	:95P:	Account Servicer/Depository	ASDP		:4!c//4!a2!a2!c [3!c]	OCSDAT WWXXX	BIC of Account Servicer

Optional Repetitive Subsequence D1 Penalties per Currency for a Party

M	:16R:	Start of Block			16c	PENACUR	
---	-------	----------------	--	--	-----	---------	--

M/O	Tag	Field Name	Qualifier	Option	Format	Codes	Description
M	:11A:	Currency	PECU		:4!c//3!a		Currency of Penalties
M	:98A:	Computation Date	DACO		:4!c//8!n		Penalty Detection date/time It is the day for which the penalty was computed. It is: -The date on which the instruction matched for LMFP. -The date on which an instruction fails to settle for SEFP. Note: This date is not updated upon re-calculation of the penalty and always relates to the business day for which the penalty was initially computed.
M	:95P:	Related Party	REPA		:4!c//4!a2!a2!c[3!c]		Identification of the party reported as party imposed with the penalties reported or party credited with the penalty(ies).
M	:95P:	Counterparty's Account Servicer/Depository	CASD		:4!c//4!a2!a2!c[3!c]		Party that services the account of the counterparty to the party reported as Related Party.
M	:22F:	Party Capacity Indicator (Party Type of Party)	TRCA		:4!c/[8c]/4!c	NCS D CCPA CSDP EXTE	CSD CCP Participants of CSD External CSD
Optional Repetitive Subsequence D1a Penalties per Counterparty							
M	:16R:	Start of Block				PENACO UNT	
M	:95P:	Related Party	REPA		:4!c//4!a2!a2!c[3!c]		Counterparty
M	:22F:	Party Capacity Indicator (Party Type of Party)	TRCA		:4!c/[8c]/4!c	NCS D CCPA CSDP EXTE	CSD CCP Participants of CSD External CSD

M/O	Tag	Field Name	Qualifier	Option	Format	Codes	Description
M	:19A:	Bilateral Net Amount	AGNT		:4!c//[N]3!a15d		Daily net for a party vs counterparty
Optional Repetitive Subsequence D1a1 Penalty Details							
M	:16R:	Start of Block			16c	PENDET	
O	:20C:	Penalty Reference	PREF		:4!c//16x		individual identification of the penalty
M	:20C:	Penalty Common Reference	PCOM		:4!c//16x		Common Reference of the penalty for both the failing and the non-failing parties
O	:20C:	Previous Penalty Common Reference	PPCM		:4!c//16x		Previous common identification of the penalty (following reallocation)
O	:20C:	Previous Penalty Reference	PPRF		:4!c//16x		Previous individual identification of the penalty (following reallocation)
M	:22H:	Penalty Type	PNTP		:4!c//4!c	SEFP LMFP	Settlement Fail Penalty Late Matching Fail penalty
M	:22H:	Calculation Method	CALM		:4!c//4!c	BOTH CASH MIXE SECU	Sum of Penalties Based on Securities and Cash Penalty Based on Cash Penalty Based on the Discount Rate Penalty Based on Securities
O	:17B:	Amount Considered For Aggregation Flag	CMPU		:4!c//1!a	Y N	Indicates whether or not the amount calculated for the reported penalty will be added to the aggregated amounts at global level.
O	:25D:	Penalty Status	PNST		:4!c//[8c]/4!c	ACTV REMO	Penalty active Penalty removed
Optional Repetitive field							
O	:24B:	Reason Code	ACTV			OTHR RALO SWIC	Other Reallocation Switch

M/O	Tag	Field Name	Qualifier	Option	Format	Codes	Description
						UPDT	Update
			REMO			OTHR	Other
						RALO	Reallocation
						SEMP	Paym Syst closed
						SWIC	Switch
						INSO	Insolvency
						SESU	Settmt suspended
						SUSP	Trading susp.
						TEIM	Technical reasons
O	:70D:	Status Narrative	REAS		:4!c//6*35x		additional description of REMO/OTHR or REMO/SWIC
M	:19A:	Amount Computed	AMCO		:4!c//[N]3!a15d		Amount computed for the penalty
M	:99A:	Number Days	DAAC		:4!c//[N]3!n		For Settlement Fail =1. For Late Matching Fail = no. of business days since ISD.
Optional Repetitive Subsequence D1a1A Calculation Details							
M	:16R:	Start of Block			16c	CALDET	
M	:98A:	Penalty Date/Time	PEDA		:4!c//8!n		Date/time on which the penalty is calculated.
O	:17B:	Missing Reference Data Flag	MRED		:4!c//1!a	Y	reference data needed for penalty calculation is missing
						N	reference data needed for penalty calculation is not missing
Optional Repetitive Subsequence D1a1A1 Financial Instrument Attributes							
M	:16R:	Start of Block				FIA	
M	:35B:	Identification of the Financial Instrument			ISIN1!e12!c		ISIN
O	:12A:	Type of Financial Instrument	CLAS		:4!c//REGL/30x	SHRS	security type code as defined in the CSD Regulation
						SOVR	
						DEBT	
						SECU	

M/O	Tag	Field Name	Qualifier	Option	Format	Codes	Description
						ETFS	
						UCIT	
						MMKT	
						EMAL	
						OTHER	
O	:17B:	Liquidity Flag	LIQU		:4!c//1!a	Y N	Field present only if liquidity/illiquidity relevant for penalty calculation
O	:17B:	Security subject to penalties Flag	OKPE		:4!c//1!a	Y N	If this field is the security is subject to penalties
O	:17B:	SME Growth Market Flag	SMEM		:4!c//1!a	Y N	Field present only if „traded on SME growth market“ relevant for penalty calculation.
O	:94B:	Place of Trade	TRAD		:4!c/[8c]/4!c/3 0x]	EXCH	Present if both instructions have same MIC in place of Trade
O	:92B:	Exchange Rate 1	EXCH		:4!c//3!a/3!a/1 5d		The first Ccy is the Unit Ccy, the second Ccy is the quoted Ccy
O	:92B:	Exchange Rate 2	EXCH		:4!c//3!a/3!a/1 5d		The first Ccy is the Unit Ccy, the second Ccy is the quoted Ccy
O	:92A:	Penalty Rate	CBON GBON GOMB ILSH LISH NBON OTHR		:4!c//[N]15d		Corporate Bonds SME Growth Market (non-Bonds) Government and Municipal Bonds Illiquid Shares Liquid Shares SME Growth Market Bonds Other Financial Instruments
M	:16S:	End of Block				FIA	

M/O	Tag	Field Name	Qualifier	Option	Format	Codes	Description
End of Subsequence D1a1A1 Financial Instrument Attributes							
O	:92A:	Penalty Discount Rate	PDRA		:4!c//[N]15d		discount rate of the relevant currency
O	:19A:	Penalty Sub Amount Cash	CASH		:4!c//[N]3!a15d		
O	:19A:	Penalty Sub Amount Securities	SECU		:4!c//[N]3!a15d		
M	:16S:	End of Block				CALDET	
End of Optional Repetitive Subsequence D1a1A Calculation Details							
Optional Subsequence D1a1B Related Transaction							
M	:16R:	Start of Block				RELTRAN	
M	:20C:	Account Owner Reference	ACOW		:4!c//16x		Account Owner Reference: Settlement Instruction
O	:20C:	Other References	ASRF		:4!c//16x		Account Servicer Reference
			PCTI				Third party Reference
			MITI				T2S Reference
			COMM				Common Reference
			CORP				Corporate Action Event Id
			RELA				Matching Reference
M	:16S:	End of Block			16c	RELTRAN	
End of optional Subsequence D1a1B Related Transactions							
M	:16S:	End of Block			16c	PENDET	
End optional Repetitive subsequence D1a1 Penalty Details							
M	:16S:	End of Block			16c	PENACOUNT	
End optional Repetitive subsequence D1a Penalties per Counterparty							
M	:16S:	End of Block			16c	PENACUR	
End optional Repetitive subsequence D1 Penalties per Currency for a Party							
M	:16S:	End of Block			16c	PENA	

M/O	Tag	Field Name	Qualifier	Option	Format	Codes	Description
		End optional Repetitive subsequence D Penalties					

1.4.8.2.2 Daily Modified Examples

If there are no modified penalties to report NO MT537 will be sent for MT537 Daily Modified.

Modified penalties to report

The failing and non-failing parties of a settlement fail penalty initially calculated on 2019/06/26 are switched.

:16R:GENL
:28E:1/ONLY
:20C::SEME//DAILYMODIEX0100
:23G:PENA
:98A::STAT//20190703
:98C::PREP//20190703/120000
:22F::SFRE//DAIL
:22H::STST//PENA
:95P::ACOW//PRTDATWWXXX
:97A::SAFE//NONREF
:17B::ACTI//Y
:16S:GENL
:16R:PENA
:69A::STAT//20190603/20190701
:22F::CODE//FWAM
:95P::ASDP//OCSDATWWXXX
:16R:PENACUR
:11A::PECU//EUR
:98A::DACO//20190626
:95P::REPA//PRTDATWWXXX
:95P::CASD//CSDABIC1XXX
:22F::TRCA//CSDP
:16R:PENACOUNT
:95P::REPA//ECSDBIC1XXX
:22F::TRCA//EXTE
:19A::AGNT//EUR56,
:16R:PENDET
:20C::PREF//F201906260000007
:20C::PCOM//201906260000007
:22H::PNTP//SEFP
:22H::CALM//SECU
:22H::PNST//ACTV
:24B::ACTV//SWIC
:70D::REAS//Penalty switched, fail is on the ot

her party.
:19A::AMCO//EUR56,
:99A::DAAC//001
:16R:CALDET
:98A::PEDA//20190626
:16R:FIA
:35B:ISIN ISIN000000004
:12A::CLAS/REGL/SHRS
:17B::LIQU//Y
:17B::SMEM//N
:92A::LISH//1,00
:16S:FIA
:16S:CALDET
:16R:RELTRAN
:20C::ACOW//PARTICIPANT-D007
:20C::MITI//T2S10000000000007
:20C::COMM//T2S00000000000007
:16S:RELTRAN
:16S:PENDET
:16S:PENACOUNT
:16S:PENACUR
:16S:PENA

1.4.8.3 MT537 – Monthly Penalty Report

This monthly report contains a summary of penalties calculated on instructions that matched late or failed to settle in the monthly penalty period reported on. One MT537 is sent for penalties related to Intra and Cross instructions and a separate MT537 is sent for penalties related to external instructions. In case there are no penalties to report for the period in question a message with Activity Flag set to N will be sent.

This report contains neither calculation details nor details of the underlying transactions.

1.4.8.3.1 Content

M/O	Tag	Field Name	Qualifier	Option	Format	Codes	Description
Mandatory Sequence A General Information							
M	:16R:	Start of Block			16c	GENL	
M	:28E:	Page Number /Continuation Indicator			5n/4!c	LAST MORE	Last page of a statement with more than one page. Intermediate page of a statement which contains additional pages.

M/O	Tag	Field Name	Qualifier	Option	Format	Codes	Description
						ONLY	Only page of the statement.
M	:20C:	Sender's Message Reference	SEME		:4!c//16x		Reference assigned by the sender to unambiguously identify the message.
M	:23G:	Function of the Message	PENA		4!c/4!c]		Penalty Fees
M	:98A:	Statement Date	STAT		:4!c//8!n		Date at which the statement is based.
M	:98C:	Preparation Date/Time	PREP		:4!c//8!n6!n		Date and time at which the message was prepared.
M	:22F:	Statement Frequency Indicator	SFRE		:4!c/[8c]/4!c	MNTH	Statement is sent daily.
M	:22H:	Statement Structure Type Indicator	STST		:4!c//4!c	PENA	Statement contains penalties.
M	:95P:	Account Owner	ACOW		:4!c//4!a2!a2!c[3!c]		Account Owner
M	:97A:	Safekeeping Account	SAFE		:4!c//35x		MT537 PENA applies to a customer and not a particular safekeeping account. This field will be filled with the value NONREF.
M	:17B:	Activity Flag	ACTI		:4!c//1!a	Y	There are penalties reported in this statement.
						N	There are no penalties reported in this statement.
M	:16S:	End of Block			16c	GENL	
End of Sequence A General Information							
Optional Repetitive Sequence D Penalties							
M	:16R:	Start of Block			16c	PENA	
M	:69A:	Period			:4!c//8!n/8!n	STAT	Period on which the statement is reporting. date1 = 1 st of Month, date2 = Last Day of Month

M/O	Tag	Field Name	Qualifier	Option	Format	Codes	Description
M	:22F:	Complete/ Updates Indicator	CODE		:4!c/[8c]/4!c	/T2S/MN TH	Daily Modified Penalty List
M	:95P:	Account Servicer/Deposit ory	ASDP		:4!c//4!a2!a2!c [3!c]	OCSDAT WWXXX	BIC of Account Servicer

Optional Repetitive Subsequence D1 Penalties per Currency for a Party

M	:16R:	Start of Block			16c	PENACU R	
M	:11A:	Currency	PECU		:4!c//3!a		Currency of Penalties
O	:98A:	Payment Date	PAYD		:4!c//8!n		
O	:97A:	Cash Account	CASH		:4!c//35x		
M	:95P:	Related Party	REPA		:4!c//4!a2!a2!c [3!c]		Identification of the party reported as party imposed with the penalties reported or party credited with the penalty(ies).
M	:95P:	Counterparty's Account Servicer/Deposit ory	CASD		:4!c//4!a2!a2!c [3!c]		Party that services the account of the counterparty to the party reported as Related Party.
M	:22F:	Party Capacity Indicator (Party Type of Party)	TRCA		:4!c/[8c]/4!c	NCS D CCPA CSDP EXTE	CSD CCP Participants of CSD External CSD

Optional Repetitive Subsequence D1a Penalties per Counterparty

M	:16R:	Start of Block				PENACO UNT	
M	:95P:	Related Party	REPA		:4!c//4!a2!a2!c [3!c]		Counterparty
M	:22F:	Party Capacity Indicator (Party Type of Party)	TRCA		:4!c/[8c]/4!c	NCS D CCPA CSDP EXTE	CSD CCP Participants of CSD External CSD
M	:19A:	Bilateral Net Amount	AGNT		:4!c//[N]3!a15 d		Daily net for a party vs counterparty

M/O	Tag	Field Name	Qualifier	Option	Format	Codes	Description
Optional Repetitive Subsequence D1a1 Penalty Details							
M	:16R:	Start of Block			16c	PENDET	
O	:20C:	Penalty Reference	PREF		:4!c//16x		individual identification of the penalty
M	:20C:	Penalty Common Reference	PCOM		:4!c//16x		Common Reference of the penalty for both the failing and the non-failing parties
O	:20C:	Previous Penalty Common Reference	PPCM		:4!c//16x		Previous common identification of the penalty (following reallocation)
O	:20C:	Previous Penalty Reference	PPRF		:4!c//16x		Previous individual identification of the penalty (following reallocation)
M	:22H:	Penalty Type	PNTP		:4!c//4!c	SEFP	Settlement Fail Penalty
						LMFP	Late Matching Fail penalty
M	:22H:	Calculation Method	CALM		:4!c//4!c	BOTH	Sum of Penalties Based on Securities and Cash
						CASH	Penalty Based on Cash
						MIXE	Penalty Based on the Discount Rate
						SECU	Penalty Based on Securities
O	:17B:	Amount Considered For Aggregation Flag	CMPU		:4!c//1!a	Y N	Indicates whether or not the amount calculated for the reported penalty will be added to the aggregated amounts at global level.
O	:70D:	Status Narrative	REAS		:4!c//6*35x		additional description of REMO/OTHR or REMO/SWIC
M	:19A:	Amount Computed	AMCO		:4!c//[N]3!a15d		Amount computed for the penalty

M/O	Tag	Field Name	Qualifier	Option	Format	Codes	Description
M	:99A:	Number Days	DAAC		:4!c//[N]3!n		For Settlement Fail =1. For Late Matching Fail = no. of business days since ISD.
End optional Repetitive subsequence D1a1 Penalty Details							
M	:16S:	End of Block			16c	PENACO UNT	
End optional Repetitive subsequence D1a Penalties per Counterparty							
M	:16S:	End of Block			16c	PENACU R	
End optional Repetitive subsequence D1 Penalties per Currency for a Party							
M	:16S:	End of Block			16c	PENA	
End optional Repetitive subsequence D Penalties							

1.4.8.3.2 MT537 Monthly Examples

No monthly penalties to report

:16R:GENL
:28E:1/ONLY
:20C::SEME//MNTHEX0100
:23G:PENA
:98A::STAT//20190718
:98C::PREP//20190718120000
:22F::SFRE//MNTH
:22H::STST//PENA
:95P::ACOW//CSDABIC1XXX
:97A::SAFE//NONREF
:17B::ACTI//N
:16S:GENL

Monthly penalties to report

For June 2019 participant PRTAATWWXXX has 2 debit penalties with counterparty PRTBATWWXXX (also serviced by OCSDATWWXXX) and 1 debit penalty with counterparty PRTZESMMXXX serviced by CSDZBIC1XXX

:16R:GENL
:28E:1/ONLY
:20C::SEME//MNTHEX0100
:23G:PENA
:98A::STAT//20190718
:98C::PREP//20190718120000

:22F::SFRE//MNTH
:22H::STST//PENA
:95P::ACOW// PRTAATWWXXX
:97A::SAFE//NONREF
:17B::ACTI//Y
:16S::GENL
:16R::PENA
:69A::STAT//20190601/20190630
:22F::CODE/T2S/MNTH
95P::ASDP//OCSDATWWXXX
:16R::PENACUR
:11A::PECU//EUR
:98A::PAYD//20190724
:97A::CASH//PRTAEUR001
:95P::REPA//PRTAATWWXXX
:95P::CASD//OCSDATWWXXX
:22F::TRCA//CSDP
:16R::PENACOUNT
:95P::REPA//PRTBATWWXXX
:22F::TRCA//CSDP
:19A::AGNT//NEUR31,03
:16R::PENDET
:20C::PREF//F201906210000001
:20C::PCOM//201906210000001
:22H::PNTP//SEFP
:22H::CALM//SECU
:19A::AMCO//NEUR25,
:99A::DAAC//001
:16S::PENDET
:16R::PENDET
:20C::PREF//N201906210000002
:20C::PCOM//201906210000002
:22H::PNTP//SEFP
:22H::CALM//MIXE
:19A::AMCO//NEUR6,03
:99A::DAAC//001
:16S::PENDET
:16S::PENACOUNT
:16S::PENACUR
:16R::PENACUR
:11A::PECU//EUR
:98A::PAYD//20190724
:97A::CASH//PRTAEUR001
:95P::REPA//PRTAATWWXXX

:95P::CASD//CSDZBIC1XXX

:22F::TRCA//CSDP

:16R::PENACOUNT

:95P::ASDP//CSDZBIC1XXX

:95P::REPA//PRTZESMMXXX

:22F::TRCA//CSDP

:19A::AGNT//NEUR5,42

:16R::PENDET

:20C::PREF//F201906210000003

:20C::PCOM//201906210000003

:22H::PNTP//SEFP

:22H::CALM//CASH

:19A::AMCO//NEUR5,42

:99A::DAAC//001

:16S::PENDET

:16S::PENACOUNT

:16S::PENACUR

:16S::PENA

2. SWIFT Manual for Income and Corporate Actions ISO 15022

2.1 Introduction

This chapter describes the content of SWIFT message types used for Income and Corporate Action Events under SWIFT ISO 15022. Available message types in SWIFT ISO 15022

Message Type	Notification Type	Used for Income	Used for Corporate Action
MT564	Corporate Action Notification	x	x
MT565	Corporate Action Instruction		x
MT566	Corporate Action Confirmation	x	x
MT567	Corporate Action Status and Processing Advice		x
MT568	Corporate Action Narrative	x	x

2.2 Scope

This chapter describes the SWIFT messages, communication flows for the below listed events and provides some examples of the respective events.

2.2.1 Income Event List (SWIFT ISO 15022)

Code	Short description	Long description
CAPD	Capital Distribution	The corporate event pays shareholders an amount in cash issued from the Capital account. There is no reduction to the face value of a single share (or the share has no par value). The number of circulating shares remains unchanged.

CAPG	Capital Gains Distribution	Distribution of profits resulting from the sale of company assets, for example, Shareholders of Mutual Funds, Unit Trusts, or SICAVs are recipients of capital gains distributions which are often reinvested in additional shares of the fund.
DECR	Decrease in Value	Reduction of face value of a single share or the value of fund assets. The number of circulating shares/units remains unchanged. This event may include a cash pay out to holders.
DVCA	Cash Dividend	Distribution of cash to shareholders, in proportion to their equity holding. Ordinary dividends are recurring and regular. Shareholder must take cash and may be offered a choice of currency.
EXWA (MAND)	Warrant Exercise mandatory	Option offered to holders to buy (call warrant) or to sell (put warrant) a specific amount of stock, cash, or commodity, at a predetermined price, during a predetermined period of time (which usually corresponds to the life of the issue).
INTR	Interest Payment	Regular interest payment distributed to holders of an interest-bearing asset.
MCAL	Full Call/Early Redemption	The redemption of an entire issue outstanding of securities, for example, bonds, preferred equity, funds, by the issuer or its agent, for example, asset manager, before final maturity.
PCAL	Partial Redemption with Reduction of Nominal Value	Securities are redeemed in part before their scheduled final maturity date with reduction of the nominal value of the securities. The outstanding amount of securities will be reduced proportionally.
PRED	Partial Redemption Without Reduction of Nominal Value	Securities are redeemed in part before their scheduled final maturity date without reduction of the nominal value of the securities. This is commonly done by pool factor reduction.
REDM	Final Maturity	The redemption of an entire issue outstanding of securities, for example, bonds, preferred equity, funds, by the issuer or its agent, for example, asset manager, at final maturity.
SHPR	Shares Premium Dividend	This corporate event pays shareholders an amount in cash issued from the shares premium reserve. It is similar to a dividend but with different tax implications.
WRTH	Worthless Securities	Booking out of valueless securities.

2.2.2 Event List for Corporate Actions (SWIFT ISO 15022)

Code	Short description	Long description
BIDS	Repurchase Offer/Issuer Bid/Reverse Rights	Offer to existing shareholders by the issuing company to repurchase equity or other securities convertible into equity. The objective of the offer is to reduce the number of outstanding equities.
BMET	Bond Holder Meeting	Physical meeting of bond holders.
BONU	Bonus Issue/Capitalisation Issue	Bonus, scrip or capitalisation issue. Security holders receive additional assets free of payment from the issuer, in proportion to their holding.
BPUT	Put Redemption	Early redemption of a security at the election of the holder subject to the terms and condition of the issue with no reduction in nominal value.
CERT	Non-US TEFRA D Certification	Non-US beneficial owner certification requirement for exchange of temporary to permanent notes.
CHAN	Change	Information regarding a change further described in the corporate action details.
CLSA	Class Action/Proposed Settlement	Situation where interested parties seek restitution for financial loss. The security holder may be offered the opportunity to join a class action proceeding and would need to respond with an instruction.
CONS	Consent	Procedure that aims to obtain consent of holder to a proposal by the issuer or a third party without convening a meeting. For example, consent to change the terms of a bond.
CONV	Conversion	Conversion of securities (generally convertible bonds or preferred shares) into another form of securities (usually common shares) at a pre-stated price/ratio.
DFLT	Bond Default	Failure by the company to perform obligations defined as default events under the bond agreement and that have not been remedied.

DRIP	Dividend Reinvestment	Dividend payment where holders can keep cash or have the cash reinvested in the market by the issuer into additional shares in the issuing company. To be distinguished from DVOP as the company invests the dividend in the market rather than creating new share capital in exchange for the dividend
DSCL	Disclosure	Requirement for holders or beneficial owners to disclose their name, location and holdings of any issue to the issuer. This event only occurs with the characteristic VOLU, otherwise it is part of the SRD II.
DTCH	Dutch Auction	An action by a party wishing to acquire a security. Holders of the security are invited to make an offer to sell, within a specific price range. The acquiring party will buy from the holder with lowest offer.
DVOP	Dividend Option	Distribution of a dividend to shareholders with a choice of benefit to receive. Shareholders may choose to receive shares or cash. To be distinguished from DRIP as the company creates new share capital in exchange for the dividend rather than investing the dividend in
DVSE	Stock Dividend	Dividend paid to shareholders in the form of equities of the issuing corporation.
EXOF	Exchange	Exchange of holdings for other securities and/or cash. The exchange can be either mandatory or voluntary involving the exchange of outstanding securities for different securities and/or cash. For example, "exchange offer", "capital reorganisation" or "funds separation".
EXRI	Call on Intermediate Securities	Call or exercise on nil paid securities or intermediate securities resulting from an intermediate securities distribution (RHD). This code is used for the second event, when an intermediate securities' issue (rights/coupons) is composed of two events, the first event being the distribution of intermediate securities.
EXTM	Maturity Extension	As stipulated in a bond's Terms and Conditions, the issuer or the bond-holder may prolong the maturity date of a bond. After extension, the security may differ from original issue (new rate or maturity date). May be subject to bondholder's approval.
EXWA (VOLU/ CHOS)	Warrant Exercise	Option offered to holders to buy (call warrant) or to sell (put warrant) a specific amount of stock, cash, or commodity, at a predetermined price, during a predetermined period of time (which usually corresponds to the life of the issue).

INFO	Information	Information provided by the issuer having no accounting/financial impact on the holder.
LIQU	Liquidation Dividend/Liquidation Payment	A distribution of cash, assets or both. Debt may be paid in order of priority based on preferred claims to assets specified by the security.
MEET	Annual General Meeting	Annual general meeting.
MRGR	Merger	Exchange of outstanding securities, initiated by the issuer which may include options, as the result of two or more companies combining assets, that is, an external, third party company. Cash payments may accompany share exchange.
OMET	Ordinary General Meeting	Ordinary general meeting.
OTHR	Other event	Other event, use only when no other event type applies, for example, a new event type.
PARI	Pari-Passu	Occurs when securities with different characteristics, for example, shares with different entitlements to dividend or voting rights, become identical in all respects, for example, pari-passu or assimilation. May be scheduled in advance, for example, shares resulting from a bonus may become fungible after a pre-set period of time, or may result from outside events, for example, merger, reorganisation, issue of
PRIO	Priority Issue	Form of open or public offer where, due to a limited amount of securities available, priority is given to existing shareholders.
REDO	Redenomination	Event by which the unit (currency and/or nominal) of a security is restated, for example, nominal/par value of security in a national currency is restated in another currency.
RHDI	Intermediate Securities Distribution	The distribution of intermediate securities or privilege that gives the holder the right to take part in a future event.
SOFF	Spin-Off	A distribution of subsidiary stock to the shareholders of the parent company without a surrender of shares. Spin-off represents a form of divestiture usually resulting in an independent company or in an existing company. For example, demerger, distribution,

SPLF	Stock Split/Change in Nominal Value/Subdivision	Increase in a corporation's number of outstanding equities without any change in the shareholder's equity or the aggregate market value at the time of the split. Equity price and nominal value are reduced accordingly
SPLR	Reverse Stock Split/Change in Nominal Value	Decrease in a company's number of outstanding equities without any change in the shareholder's equity or the aggregate market value at the time of the split. Equity price and nominal value are increased
TEND	Tender/Acquisition/Takeover/Purchase Offer/Buyback	An offer made to shareholders, normally by a third party, requesting them to sell (tender) or exchange their equities.
WRTH	Worthless	Booking out of valueless securities.
XMET	Extraordinary or Special General Meeting	Extraordinary or special general meeting.

2.2.3 Communication Flow SWIFT ISO 15022

SWIFT	Description
MT564 NEWM	First MT564 notification will be sent right after announcement of the corporate action event and contains the details of a corporate action event along with the possible elections or choices available.
MT564 REPL	This message will be sent when there were changes in the conditions of a corporate action event for which a notification has been already sent.
MT564 WITH	This message will be sent when the event is cancelled.
MT565	This message is used to provide the custodian with instructions on how the account owner wishes to proceed with a corporate action event. Instructions include investment decisions regarding the exercise of rights issues, the election of stock or cash when the option is available, and decisions on the conversion or tendering of securities.
MT566	This message is used to confirm that securities and/or cash have been credited/debited.
MT567	This message is used to advise the status, or a change in status, of a corporate action-related transaction previously instructed by, or executed on behalf of, the account owner. This will include the acknowledgement/rejection of a corporate

action instruction or the acknowledgement/rejection of a request to cancel an outstanding instruction.

MT568 This message is used to provide complex instructions or narrative details relating to a corporate action event.

2.2.4 MAND Income Event Lifecycle

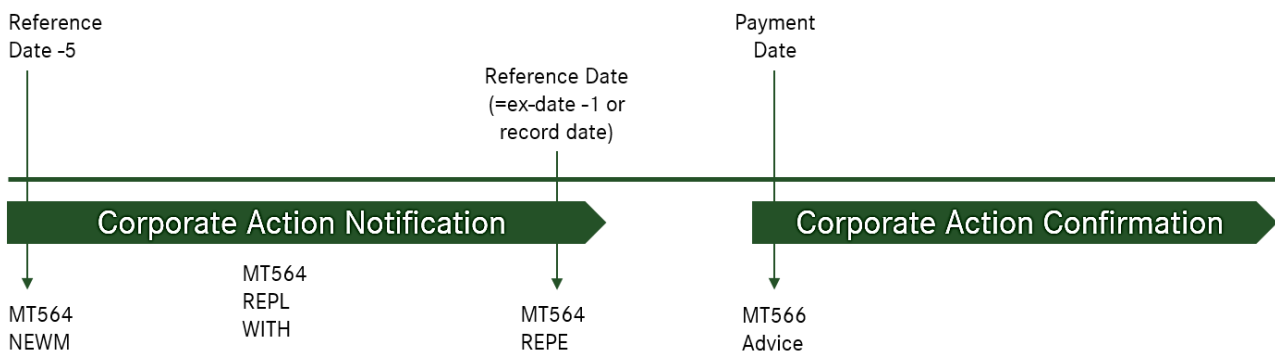

2.2.5 MAND Corporate Action Event Lifecycle

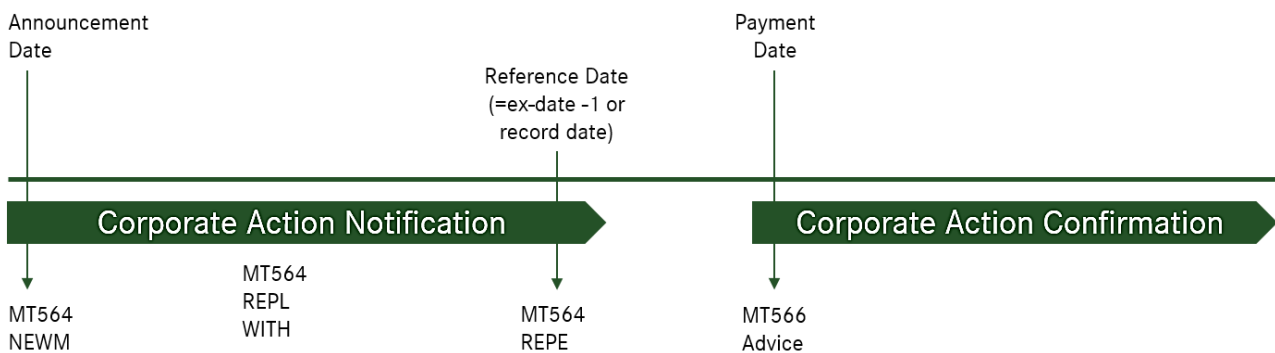

2.2.5.1 VOLU/CHOS Corporate Action Event Lifecycle

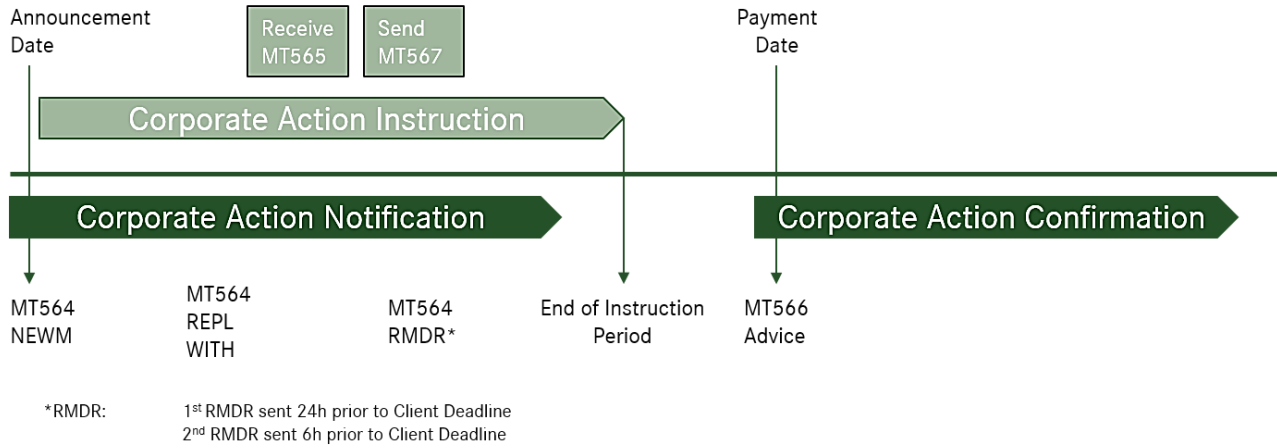

2.2.5.2 Linking of Messages

Corporate Action Reference is used for whole message flow and linking of messages via sender's reference.

MT564 NEWM	MT564 REPL
:16R:GENL	:16R:GENL
:20C::CORP//TEND00004901	:20C::CORP//TEND00004901
:20C::SEME//CS10524320	:20C::SEME//CS10529860
:23G:NEWM	:23G:REPL
:22F::CAEV//TEND	:22F::CAEV//TEND
:22F::CAMV//VOLU	:22F::CAMV//VOLU
:98C::PREP// 20190828131722	:98C::PREP//20190828142633
:25D::PROC//COMP	:25D::PROC//COMP
:16S:GENL	:16R:LINK
	:13A::LINK//564
	:20C::PREV//CS10524320
	:16S:LINK
	:16S:GENL
MT566	MT567
:16R:GENL	:16R:GENL

:20C::CORP//TEND00004901	:20C::CORP//TEND00004901
:20C::SEME//CS10525020	:20C::SEME//CS10533720
:23G:NEWM	:23G:INST
:22F::CAEV//TEND	:22F::CAEV//TEND
:98C::PREP//20190828134628	:98C::PREP//20190830130348
:16R:LINK	:16R:LINK
:13A::LINK//564	:13A::LINK//565
:20C::PREV//CS10524320	:20C::RELA//20190828scb06
:16S:LINK	:16S:LINK
:16R:LINK	:16R:STAT
:13A::LINK//565	:25D::IPRC//PEND
:20C::RELA//20190828scb06	:16S:STAT
:16S:LINK	:16S:GENL
:16R:LINK	:16R:CADETL
:13B::LINK//sese.025.001.07	:13A::CAON//001
:20C::RELA//CS000245595	:22H::CAOP//SECU
:16S:LINK	:97A::SAFE// OCSD123400
:16S:GENL	:35B:ISIN AT0000937503
	VOESTALPINE AKT O.N.
	:36B::STAQ//UNIT/888,
	:16S:CADETL

2.2.5.3 Explanation of used SWIFT Fields

Mandatory Sequence A (General Information)

20C - Corporate Action Reference

OeKB CSD's unambiguous reference of the corporate action, always commencing with event name (e.g. DVCA00100168).

20C - Sender's Message Reference

OeKB CSD's unambiguous reference of the message, always commencing with CS.

20C - Corporate Action Event Reference

The COAF (= Corporate Action Event Reference) is a worldwide accepted standard for identifying corporate actions in each national market. OeKB CSD acts as the allocation agent of the COAF for Issuer CSD securities. This unambiguous reference of the corporate action event, always commencing with AT.

25D - Processing Status

Status which defines the completeness of information contained in the notification

COMP: confirmed yes, official yes

COMU: complete yes, official no

PREC: complete no, official yes

PREU: complete no, official no

Repetitive Optional Subsequence A1 (Linkages)

13A - Linked Message

This field contains the message type number of the previously sent message.

20C - Previous Reference

This field contains the reference of the linked message.

Repetitive Optional Subsequence B2 (Account Information)

93B - Eligible Balance

ELIG: The entitlement calculation is based on this balance. The balance doesn't include the pending trades with status matched.

PEND: The pending receipt balance includes OTC instructions.

PENR: The pending delivery balance includes OTC instructions.

SETT: Settled balance.

BLOK: Balance having a position nature blocked.

Optional Sequence D (Corporate Action Details)

22F - Indicator

DIVI/REGR: Dividend paid at regular interval (for example "quarterly").

DIVI/INTE: Dividend declared and paid before annual earnings have been determined. DIVI/FINL: Payment of a dividend, less the amounts already paid through interim dividends. DIVI/SPEC: Dividend in addition to the regular dividend being paid by the company.

Optional Sequence F Additional Information

70E – Narrative

ADTX: Information if a Breakdown Instruction has been created.

2.3 Income SWIFT Examples (SWIFT ISO 15022)

2.3.1 DVCA – Cash Dividend

2.3.1.1 DVCA MAND - MT564 NEWM for a Domestic ISIN

:16R:GENL

:20C::CORP//DVCA00058311

:20C::SEME//CS12217390

:20C::COAF//ATDVCA00058311

:23G:NEWM

:22F::CAEV//DVCA

:22F::CAMV//MAND

:98C::PREP//20210108151136

:25D::PROC//COMP

:16S:GENL

:16R:USECU

:35B:ISIN AT0000730007

ANDRITZ AKT O.N.

:16R:ACCTINFO

:97A::SAFE//OCSD123400

:94F::SAFE//CUST/OCSDATWW

:93B::ELIG//UNIT/21,

:93B::PEND//UNIT/2500,

:93B::SETT//UNIT/21,

:16S:ACCTINFO

:16S:USECU

:16R:CADETL

:98A::XDTE//20210104

:98A::RDTE//20210105

:16S:CADETL

:16R:CAOPTN

:13A::CAON//001

:22F::CAOP//CASH

:11A::OPTN//EUR

:17B::DFLT//Y

:16R:CASHMOVE

:22H::CRDB//CRED

:98A::PAYD//20210108

:92F::GRSS//EUR0,001

:92A::TAXR//27,5

:16S:CASHMOVE

:16S:CAOPTN

2.3.1.2 DVCA MAND – MT564 REPE

:16R:GENL

:20C::CORP//DVCA00047685

:20C::SEME//CS20036980

:20C::COAF//ATDVCA00047685

:23G:REPE

:22F::CAEV//DVCA
:22F::CAMV//MAND
:98C::PREP//20200124001639
:25D::PROC//COMP
:16R:LINK
:13A::LINK//564
:20C::PREV//CS20036860
:16S:LINK
:16S:GENL
:16R:USECU
:35B:ISIN AT0000741053
EVN AKT O.N.
:16R:ACCTINFO
:97A::SAFE// OCSD123400
:94F::SAFE//CUST/OCSDATWW
:93B::ELIG//UNIT/10639519,
:93B::PEND//UNIT/17190,
:93B::PENR//UNIT/21655,
:93B::SETT//UNIT/10639519,
:16S:ACCTINFO
:16S:USECU
:16R:CADETL
:98A::XDTE//20200122
:98A::RDTE//20200123
:16S:CADETL
:16R:CAOPTN

:13A::CAON//001
:22F::CAOP//CASH
:11A::OPTN//EUR
:17B::DFLT//Y
:16R:CASHMOVE
:22H::CRDB//CRED
:97A::CASH// CATEURXYZAATWWXXXMUSTER1
:19B::ENTL//EUR3856825,64
:19B::GRSS//EUR5319759,5
:19B::NETT//EUR3856825,64
:19B::TAXR//EUR1462933,86
:98A::PAYD//20200124
:92F::GRSS//EUR0,5
:92A::TAXR//27,5
:16S:CASHMOVE
:16S:CAOPTN

2.3.1.3 DVCA MAND - MT564 REPE - Entitlement Calculation for Cash Collection Breakdown

:16R:GENL
:20C::CORP//DVCA00047685
:20C::SEME//CS20036860
:20C::COAF//ATDVCA00047685
:23G:REPE
:22F::CAEV//DVCA
:22F::CAMV//MAND
:98C::PREP//20200124001635
:25D::PROC//COMP

:16R:LINK

:13A::LINK//564

:20C::PREV//CS19960420

:16S:LINK

:16S:GENL

:16R:USECU

:35B:ISIN AT0000741053

EVN AKT O.N.

:16R:ACCTINFO

:97A::SAFE//OCSD123400

:94F::SAFE//CUST/OCSDATWW

:93B::ELIG//UNIT/2586372,

:93B::PEND//UNIT/17190,

:93B::PENR//UNIT/21655,

:93B::SETT//UNIT/2586372,

:16S:ACCTINFO

:16S:USECU

:16R:CADETL

:98A::XDTE//20200122

:98A::RDTE//20200123

:16S:CADETL

:16R:CAOPTN

:13A::CAON//001

:22F::CAOP//CASH

:11A::OPTN//EUR

:17B::DFLT//Y

:16R:CASHMOVE

:22H::CRDB//CRED

:97A::CASH// CATEURXYZAATWWXXXMUSTER1

:19B::ENTL//EUR937559,85

:19B::GRSS//EUR1293186,

:19B::NETT//EUR937559,85

:19B::TAXR//EUR355626,15

:98A::PAYD//20200124

:92F::GRSS//EUR0,5

:92A::TAXR//27,5

:16S:CASHMOVE

:16S:CAOPTN

:16R:ADDINFO

:70E::ADTX//Direct payment as per your

instruction - no processing of

credit payments by OeKB CSD.

:16S:ADDINFO

2.3.1.4 DVCA MAND – MT564 REPE Tax Breakdown

:16R:GENL

:20C::CORP//DVCA00047685

:20C::SEME//CS20036850

:20C::COAF//ATDVCA00047685

:23G:REPE

:22F::CAEV//DVCA

:22F::CAMV//MAND

:98C::PREP//20200124001635

:25D::PROC//COMP

:16R:LINK

:13A::LINK//564

:20C::PREV//CS19960580

:16S:LINK

:16S:GENL

:16R:USECU

:35B:ISIN AT0000741053

EVN AKT O.N.

:16R:ACCTINFO

:97A::SAFE//OCSD123400

:94F::SAFE//CUST/OCSDATWW

:93B::ELIG//UNIT/6510,

:93B::SETT//UNIT/6510,

:16S:ACCTINFO

:16S:USECU

:16R:CADETL

:98A::XDTE//20200122

:98A::RDTE//20200123

:16S:CADETL

:16R:CAOPTN

:13A::CAON//001

:22F::CAOP//CASH

:11A::OPTN//EUR

:17B::DFLT//Y

:16R:CASHMOVE

:22H::CRDB//CRED
:97A::CASH// CATEURXYZAATWWXXXMUSTER1
:19B::ENTL//EUR3255,
:19B::GRSS//EUR3255,
:19B::NETT//EUR3255,
:19B::TAXR//EURO,
:98A::PAYD//20200124
:92F::GRSS//EURO,5
:92A::TAXR//0,
:16S:CASHMOVE
:16S:CAOPTN
:16R:ADDINFO
:70E::ADTX//Taxation as per your instruction.
:16S:ADDINFO

2.3.1.5 DVCA MAND – MT566 NEWM

:16R:GENL
:20C::CORP//DVCA00047685
:20C::SEME//CS20049370
:20C::COAF//ATDVCA00047685
:23G:NEWM
:22F::CAEV//DVCA
:98C::PREP//20200124121555
:16R:LINK
:13A::LINK//564
:20C::PREV//CS20036980
:16S:LINK

:16R:LINK
:13B::LINK//sese.025.001.07
:20C::RELA//CS000753655
:16S:LINK
:16S:GENL
:16R:USECU
:97A::SAFE// OCSD123400
:35B:ISIN AT0000741053
EVN AKT O.N.
:93B::CONB//UNIT/10639519,
:16S:USECU
:16R:CADETL
:98A::XDTE//20200122
:98A::RDTE//20200123
:16S:CADETL
:16R:CACONF
:13A::CAON//001
:22F::CAOP//CASH
:16R:CASHMOVE
:22H::CRDB//CRED
:97A::CASH// CATEURXYZAATWWXXXMUSTER1
:19B::PSTA//EUR3856825,64
:19B::GRSS//EUR5319759,5
:19B::NETT//EUR3856825,64
:19B::TAXR//EUR1462933,86
:98A::POST//20200124

:98A::VALU//20200124

:98A::PAYD//20200124

:92F::GRSS//EUR0,5

:92A::TAXR//27,5

:16S:CASHMOVE

:16S:CACONF

2.3.1.6 DVCA MAND – MT566 OTC Trade - Compensation

:16R:GENL

:20C::CORP//DVCA00047685

:20C::SEME//CS20051190

:20C::COAF//ATDVCA00047685

:23G:NEWM

:22F::CAEV//DVCA

:98C::PREP//20200124153056

:16R:LINK

:13A::LINK//564

:20C::PREV//CS20036980

:16S:LINK

:16R:LINK

:20C::RELA//606599

:16S:LINK

:16R:LINK

:13B::LINK//sese.025.001.07

:20C::RELA//CS000753538

:16S:LINK

:16S:GENL

:16R:USECU

:97A::SAFE// OCSD123400

:35B:ISIN AT0000741053

EVN AKT O.N.

:93B::CONB//UNIT/100,

:16S:USECU

:16R:CADETL

:98A::XDTE//20200122

:98A::RDTE//20200123

:22F::ADDB//CLAI

:16S:CADETL

:16R:CACONF

:13A::CAON//001

:22F::CAOP//CASH

:16R:CASHMOVE

:22H::CRDB//CRED

:97A::CASH// CATEURXYZAATWWXXXMUSTER1

:19B::PSTA//EUR36,25

:19B::GRSS//EUR50,

:19B::NETT//EUR36,25

:19B::TAXR//EUR13,75

:98A::POST//20200124

:98A::VALU//20200124

:98A::PAYD//20200124

:92F::GRSS//EUR0,5

:92A::TAXR//27,5

:16S:CASHMOVE

:16S:CACONF

:16R:ADDINFO

:70E::ADTX//Compensation payment for OTC

instruction with trade date

19/12/2019.

:16S:ADDINFO

2.3.1.7 DVCA MAND – MT566 NEWM Tax Breakdown

:16R:GENL

:20C::CORP//DVCA00047685

:20C::SEME//CS20049250

:20C::COAF//ATDVCA00047685

:23G:NEWM

:22F::CAEV//DVCA

:98C::PREP//20200124121550

:16R:LINK

:13A::LINK//564

:20C::PREV//CS20036850

:16S:LINK

:16R:LINK

:13B::LINK//sese.025.001.07

:20C::RELA//CS000753619

:16S:LINK

:16S:GENL

:16R:USECU

:97A::SAFE// OCSD123400

:35B:ISIN AT0000741053
EVN AKT O.N.
:93B::CONB//UNIT/6510,
:16S:USECU
:16R:CADETL
:98A::XDTE//20200122
:98A::RDTE//20200123
:16S:CADETL
:16R:CACONF
:13A::CAON//001
:22F::CAOP//CASH
:16R:CASHMOVE
:22H::CRDB//CRED
:97A::CASH// CATEURXYZAATWWXXXMUSTER1
:19B::PSTA//EUR3255,
:19B::GRSS//EUR3255,
:19B::NETT//EUR3255,
:19B::TAXR//EURO,
:98A::POST//20200124
:98A::VALU//20200124
:98A::PAYD//20200124
:92F::GRSS//EUR0,5
:92A::TAXR//0,
:16S:CASHMOVE
:16S:CACONF
:16R:ADDINFO

:70E::ADTX//Taxation as per your instruction.

:16S:ADDINFO

2.3.2 DVCA – Investment Fund (Change of Dividend Rate)

Change of Dividend rate from 1,6439 Euro to 1,6698 Euro

2.3.2.1 DVCA MAND – MT564 NEWM

:16R:GENL

:20C::CORP//DVCA00044426

:20C::SEME//CS18296760

:20C::COAF//ATDVCA00044426

:23G:NEWM

:22F::CAEV//DVCA

:22F::CAMV//MAND

:98C::PREP//20190910131654

:25D::PROC//COMP

:16S:GENL

:16R:USECU

:35B:ISIN AT0000744735

AMUN SEL EUR STOCK2(T)ANT

:16R:ACCTINFO

:97A::SAFE// OCSD123400

:94F::SAFE//CUST/OCSDATWW

:93B::ELIG//UNIT/236378,44

:93B::SETT//UNIT/236378,44

:16S:ACCTINFO

:16S:USECU

:16R:CADETL

:98A::XDTE//20190911

:16S:CADETL

:16R:CAOPTN

:13A::CAON//001

:22F::CAOP//CASH

:11A::OPTN//EUR

:17B::DFLT//Y

:16R:CASHMOVE

:22H::CRDB//CRED

:98A::PAYD//20190911

:92F::GRSS//EUR1,6439

:16S:CASHMOVE

:16S:CAOPTN

2.3.2.2 DVCA MAND – MT564 REPL

:16R:GENL

:20C::CORP//DVCA00044426

:20C::SEME//CS18316490

:20C::COAF//ATDVCA00044426

:23G:REPL

:22F::CAEV//DVCA

:22F::CAMV//MAND

:98C::PREP//20190912125407

:25D::PROC//COMP

:16R:LINK

:13A::LINK//564

:20C::PREV//CS18300510

:16S:LINK

:16S:GENL

:16R:USECU

:35B:ISIN AT0000744735

AMUN SEL EUR STOCK2(T)ANT

:16R:ACCTINFO

:97A::SAFE// OCSD123400

:94F::SAFE//CUST/OCSDATWW

:93B::ELIG//UNIT/235536,21

:93B::SETT//UNIT/235536,21

:16S:ACCTINFO

:16S:USECU

:16R:CADETL

:98A::XDTE//20190911

:16S:CADETL

:16R:CAOPTN

:13A::CAON//001

:22F::CAOP//CASH

:11A::OPTN//EUR

:17B::DFLT//Y

:16R:CASHMOVE

:22H::CRDB//CRED

:98A::PAYD//20190911

:92F::GRSS//EUR1,6698

:16S:CASHMOVE

:16S:CAOPTN

2.3.3 DVCA - Cash Dividend for a Non AT ISIN

2.3.3.1 DVCA MAND – MT564 NEWM

:16R:GENL

:20C::CORP//DVCA00048586

:20C::SEME//CS20359730

:23G:NEWM

:22F::CAEV//DVCA

:22F::CAMV//MAND

:98C::PREP//20200221081606

:25D::PROC//PREC

:16S:GENL

:16R:USECU

:35B:ISIN US0326541051

ANALOG REG SHS USD0,166

:16R:ACCTINFO

:97A::SAFE// OCSD123400

:94F::SAFE//CUST/DAKVDEFF

:93B::ELIG//UNIT/30,

:93B::SETT//UNIT/30,

:16S:ACCTINFO

:16S:USECU

:16R:CADETL

:98A::XDTE//20200227

:98A::RDTE//20200228

:16S:CADETL

:16R:CAOPTN

:13A::CAON//001

:22F::CAOP//CASH

:11A::OPTN//USD

:17B::DFLT//Y

:16R:CASHMOVE

:22H::CRDB//CRED

:98A::PAYD//20200310

:92F::GRSS//USD0,62

:16S:CASHMOVE

:16S:CAOPTN

2.3.3.2 DVCA MAND – MT564 REPL

:16R:GENL

:20C::CORP//DVCA00048586

:20C::SEME//CS20370380

:23G:REPL

:22F::CAEV//DVCA

:22F::CAMV//MAND

:98C::PREP//20200224081614

:25D::PROC//COMP

:16R:LINK

:13A::LINK//564

:20C::PREV//CS20359730

:16S:LINK

:16S:GENL

:16R:USECU

:35B:ISIN US0326541051

ANALOG REG SHS USD0,166

:16R:ACCTINFO

:97A::SAFE//OCSD123400

:94F::SAFE//CUST/DAKVDEFF

:93B::ELIG//UNIT/30,

:93B::SETT//UNIT/30,

:16S:ACCTINFO

:16S:USECU

:16R:CADETL

:98A::XDTE//20200227

:98A::RDTE//20200228

:16S:CADETL

:16R:CAOPTN

:13A::CAON//001

:22F::CAOP//CASH

:11A::OPTN//USD

:17B::DFLT//Y

:16R:CASHMOVE

:22H::CRDB//CRED

:98A::PAYD//20200310

:92F::GRSS//USD0,62

:16S:CASHMOVE

:16S:CAOPTN

2.3.3.3 DVCA MAND – MT564 REPE

:16R:GENL

:20C::CORP//DVCA00048586

:20C::SEME//CS20457430
:23G:REPE
:22F::CAEV//DVCA
:22F::CAMV//MAND
:98C::PREP//20200229001714
:25D::PROC//COMP
:16R:LINK
:13A::LINK//564
:20C::PREV//CS20370380
:16S:LINK
:16S:GENL
:16R:USECU
:35B:ISIN US0326541051
ANALOG REG SHS USD0,166
:16R:ACCTINFO
:97A::SAFE//OCSD123400
:94F::SAFE//CUST/DAKVDEFF
:93B::ELIG//UNIT/30,
:93B::SETT//UNIT/30,
:16S:ACCTINFO
:16S:USECU
:16R:CADETL
:98A::XDTE//20200227
:98A::RDTE//20200228
:16S:CADETL
:16R:CAOPTN

:13A::CAON//001
:22F::CAOP//CASH
:11A::OPTN//USD
:17B::DFLT//Y
:16R:CASHMOVE
:22H::CRDB//CRED
:97A::CASH//81000000000
:19B::ENTL//USD18,6
:19B::GRSS//USD18,6
:19B::NETT//USD18,6
:98A::PAYD//20200310
:92F::GRSS//USD0,62
:16S:CASHMOVE
:16S:CAOPTN

2.3.3.4 DVCA MAND – MT566 NEWM

:16R:GENL
:20C::CORP//DVCA00048586
:20C::SEME//CS20619180
:23G:NEWM
:22F::CAEV//DVCA
:98C::PREP//20200311121628
:16R:LINK
:13A::LINK//564
:20C::PREV//CS20457430
:16S:LINK
:16S:GENL

:16R:USECU
:97A::SAFE// OCSD123400
:35B:ISIN US0326541051
ANALOG REG SHS USD0,166
:93B::CONB//UNIT/30,
:16S:USECU
:16R:CADETL
:98A::XDTE//20200227
:98A::RDTE//20200228
:16S:CADETL
:16R:CACONF
:13A::CAON//001
:22F::CAOP//CASH
:16R:CASHMOVE
:22H::CRDB//CRED
:97A::CASH//81000000000
:19B::PSTA//USD18,6
:19B::GRSS//USD18,6
:19B::NETT//USD18,6
:98A::POST//20200311
:98A::VALU//20200311
:98A::PAYD//20200310
:92F::GRSS//USD0,62
:16S:CASHMOVE
:16S:CACONF

2.3.4 INTR – Interest Payment Domestic ISIN

2.3.4.1 INTR MAND – MT564 NEWM

:16R:GENL

:20C::CORP//INTR00100925

:20C::SEME//CS20341200

:20C::COAF//ATINTR00100925

:23G:NEWM

:22F::CAEV//INTR

:22F::CAMV//MAND

:98C::PREP//20200219161721

:25D::PROC//COMP

:16S:GENL

:16R:USECU

:35B:ISIN AT000B020821

V RAIFF WOHN B STUFWA12-24

:16R:FIA

:22F::MICO//A013

:11A::DENO//EUR

:98A::COUP//20200310

:98A::MATU//20240210

:16S:FIA

:16R:ACCTINFO

:97A::SAFE// OCSD123400

:94F::SAFE//CUST/OCSDATWW

:93B::ELIG//FAMT/1257000,

:93B::SETT//FAMT/1257000,

:16S:ACCTINFO
:16S:USECU
:16R:CADETL
:98A::XDTE//20200310
:98A::RDTE//20200309
:69A::INPE//20200210/20200309
:99A::DAAC//030
:92A::INTR//3,
:16S:CADETL
:16R:CAOPTN
:13A::CAON//001
:22F::CAOP//CASH
:11A::OPTN//EUR
:17B::DFLT//Y
:16R:CASHMOVE
:22H::CRDB//CRED
:98A::PAYD//20200310
:92A::INTP//0,25
:16S:CASHMOVE
:16S:CAOPTN

2.3.4.2 INTR MAND – MT564 REPE

:16R:GENL
:20C::CORP//INTR00100925
:20C::SEME//CS20596550
:20C::COAF//ATINTR00100925
:23G:REPE

:22F::CAEV//INTR

:22F::CAMV//MAND

:98C::PREP//20200309231646

:25D::PROC//COMP

:16R:LINK

:13A::LINK//564

:20C::PREV//CS20341200

:16S:LINK

:16S:GENL

:16R:USECU

:35B:ISIN AT000B020821

V RAIFF WOHN B STUFWA12-24

:16R:FIA

:22F::MICO//A013

:11A::DENO//EUR

:98A::COUP//20200310

:98A::MATU//20240210

:16S:FIA

:16R:ACCTINFO

:97A::SAFE// OCSD123400

:94F::SAFE//CUST/OCSDATWW

:93B::ELIG//FAMT/1257000,

:93B::SETT//FAMT/1257000,

:16S:ACCTINFO

:16S:USECU

:16R:CADETL

:98A::XDTE//20200310
:98A::RDTE//20200309
:69A::INPE//20200210/20200309
:99A::DAAC//030
:92A::INTR//3,
:16S:CADETL
:16R:CAOPTN
:13A::CAON//001
:22F::CAOP//CASH
:11A::OPTN//EUR
:17B::DFLT//Y
:16R:CASHMOVE
:22H::CRDB//CRED
:97A::CASH// CATEURXYZAATWWXXXMUSTER1
:19B::ENTL//EUR3142,5
:19B::GRSS//EUR3142,5
:19B::NETT//EUR3142,5
:98A::PAYD//20200310
:92A::INTP//0,25
:16S:CASHMOVE
:16S:CAOPTN

2.3.4.3 INTR MAND – MT566 NEWM

:16R:GENL
:20C::CORP//INTR00100925
:20C::SEME//CS20605730
:20C::COAF//ATINTR00100925

:23G:NEWM

:22F::CAEV//INTR

:98C::PREP//20200310121651

:16R:LINK

:13A::LINK//564

:20C::PREV//CS20596550

:16S:LINK

:16R:LINK

:13B::LINK//sese.025.001.07

:20C::RELA//CS000779076

:16S:LINK

:16S:GENL

:16R:USECU

:97A::SAFE// OCSD123400

:35B:ISIN AT000B020821

V RAIFF WOHN B STUFWA12-24

:16R:FIA

:22F::MICO//A013

:11A::DENO//EUR

:98A::COUP//20200310

:98A::MATU//20240210

:16S:FIA

:93B::CONB//FAMT/1257000,

:16S:USECU

:16R:CADETL

:98A::XDTE//20200310

:98A::RDTE//20200309
:69A::INPE//20200210/20200309
:99A::DAAC//030
:92A::INTR//3,
:16S:CADETL
:16R:CACONF
:13A::CAON//001
:22F::CAOP//CASH
:16R:CASHMOVE
:22H::CRDB//CRED
:97A::CASH// CATEURXYZAATWWXXXMUSTER1
:19B::PSTA//EUR3142,5
:19B::GRSS//EUR3142,5
:19B::NETT//EUR3142,5
:98A::POST//20200310
:98A::VALU//20200310
:98A::PAYD//20200310
:92A::INTP//0,25
:16S:CASHMOVE
:16S:CACONF

2.3.5 REDM – Final Maturity Domestic ISIN

2.3.5.1 REDM MAND – MT564 NEWM

:16R:GENL
:20C::CORP//REDM00037613
:20C::SEME//CS20326180
:20C::COAF//ATREDM00037613

:23G:NEWM
:22F::CAEV//REDM
:22F::CAMV//MAND
:98C::PREP//20200218131654
:25D::PROC//COMP
:16S:GENL
:16R:USECU
:35B:ISIN AT000B008321
ERSTE HYPO-PF11-20/1022
:16R:FIA
:11A::DENO//EUR
:98A::MATU//20200309
:16S:FIA
:16R:ACCTINFO
:97A::SAFE// OCSD123400
:94F::SAFE//CUST/OCSDATWW
:93B::ELIG//FAMT/10000000,
:93B::SETT//FAMT/10000000,
:16S:ACCTINFO
:16S:USECU
:16R:CADETL
:98A::XDTE//20200309
:98A::RDTE//20200306
:16S:CADETL
:16R:CAOPTN
:13A::CAON//001

:22F::CAOP//CASH

:11A::OPTN//EUR

:17B::DFLT//Y

:16R::SECMOVE

:22H::CRDB//DEBT

:35B::ISIN AT000B008321

ERSTE HYPO-PF11-20/1022

:98A::PAYD//20200309

:16S::SECMOVE

:16R::CASHMOVE

:22H::CRDB//CRED

:98A::PAYD//20200309

:92A::RATE//100,

:90A::OFFR//PRCT/100,

:16S::CASHMOVE

:16S::CAOPTN

2.3.5.2 REDM MAND – MT564 REPE

:16R::GENL

:20C::CORP//REDM00037613

:20C::SEME//CS20561410

:20C::COAF//ATREDM00037613

:23G::REPE

:22F::CAEV//REDM

:22F::CAMV//MAND

:98C::PREP//20200306231712

:25D::PROC//COMP

:16R:LINK

:13A::LINK//564

:20C::PREV//CS20326180

:16S:LINK

:16S:GENL

:16R:USECU

:35B:ISIN AT000B008321

ERSTE HYPO-PF11-20/1022

:16R:FIA

:11A::DENO//EUR

:98A::MATU//20200309

:16S:FIA

:16R:ACCTINFO

:97A::SAFE// OCSD123400

:94F::SAFE//CUST/OCSDATWW

:93B::ELIG//FAMT/10000000,

:93B::SETT//FAMT/10000000,

:16S:ACCTINFO

:16S:USECU

:16R:CADETL

:98A::XDTE//20200309

:98A::RDTE//20200306

:16S:CADETL

:16R:CAOPTN

:13A::CAON//001

:22F::CAOP//CASH

:11A::OPTN//EUR
:17B::DFLT//Y
:16R:SECMOVE
:22H::CRDB//DEBT
:35B:ISIN AT000B008321
ERSTE HYPO-PF11-20/1022
:36B::ENTL//FAMT/10000000,
:98A::PAYD//20200309
:16S:SECMOVE
:16R:CASHMOVE
:22H::CRDB//CRED
:97A::CASH//CATEURXYZAATWWXXXMUSTER1
:19B::ENTL//EUR10000000,
:19B::GRSS//EUR10000000,
:19B::NETT//EUR10000000,
:98A::PAYD//20200309
:92A::RATE//100,
:90A::OFFR//PRCT/100,
:16S:CASHMOVE
:16S:CAOPTN

2.3.5.3 REDM MAND – MT566 NEWM

:16R:GENL
:20C::CORP//REDM00037613
:20C::SEME//CS20583200
:20C::COAF//ATREDM00037613
:23G:NEWM

:22F::CAEV//REDM
:98C::PREP//20200309121735
:16R:LINK
:13A::LINK//564
:20C::PREV//CS20561410
:16S:LINK
:16R:LINK
:13B::LINK//sese.025.001.07
:20C::RELA//CS000778046
:16S:LINK
:16S:GENL
:16R:USECU
:97A::SAFE// OCSD123400
:35B:ISIN AT000B008321
ERSTE HYPO-PF11-20/1022
:16R:FIA
:11A::DENO//EUR
:98A::MATU//20200309
:16S:FIA
:93B::CONB//FAMT/10000000,
:16S:USECU
:16R:CADETL
:98A::XDTE//20200309
:98A::RDTE//20200306
:16S:CADETL
:16R:CACONF

:13A::CAON//001
:22F::CAOP//CASH
:16R:SECMOVE
:22H::CRDB//DEBT
:35B:ISIN AT000B008321
ERSTE HYPO-PF11-20/1022
:36B::PSTA//FAMT/10000000,
:98A::POST//20200309
:98A::PAYD//20200309
:16S:SECMOVE
:16R:CASHMOVE
:22H::CRDB//CRED
:97A::CASH// CATEURXYZAATWWXXXMUSTER1
:19B::PSTA//EUR10000000,
:19B::GRSS//EUR10000000,
:19B::NETT//EUR10000000,
:98A::POST//20200309
:98A::VALU//20200309
:98A::PAYD//20200309
:92A::RATE//100,
:90A::OFFR//PRCT/100,
:16S:CASHMOVE
:16S:CACONF

2.3.6 EXWA – Warrant Exercise Domestic Market – Non Collection of Income for Securities Due

2.3.6.1 EXWA MAND – MT564 NEWM

:16R:GENL

:20C::CORP//EXWAM00040218

:20C::SEME//CS20481700

:20C::COAF//ATEXWAM00040218

:23G::NEWM

:22F::CAEV//EXWA

:22F::CAMV//MAND

:98C::PREP//20200302161610

:25D::PROC//COMP

:16S::GENL

:16R::USECU

:35B::ISIN AT0000A2CQT8

ERSTE OE TURBO-OS LG02/20

:16R::ACCTINFO

:97A::SAFE// OCSD123400

:94F::SAFE//CUST/OCSDATWW

:93B::ELIG//UNIT/1000,

:93B::SETT//UNIT/1000,

:16S::ACCTINFO

:16S::USECU

:16R::CADETL

:98A::XDTE//20200309

:98A::RDTE//20200306

:16S::CADETL

:16R::CAOPTN

:13A::CAON//001

:22F::CAOP//CASH

:11A::OPTN//EUR

:17B::DFLT//Y

:16R:SECMOVE

:22H::CRDB//DEBT

:35B:ISIN AT0000A2CQT8

ERSTE OE TURBO-OS LG02/20

:98A::PAYD//20200309

:16S:SECMOVE

:16R:CASHMOVE

:22H::CRDB//CRED

:98A::PAYD//20200309

:90B::OFFR//ACTU/EUR0,05

:16S:CASHMOVE

:16S:CAOPTN

2.3.6.2 EXWA MAND – MT564 REPE

:16R:GENL

:20C::CORP//EXWAM00040218

:20C::SEME//CS20564070

:20C::COAF//ATEXWAM00040218

:23G:REPE

:22F::CAEV//EXWA

:22F::CAMV//MAND

:98C::PREP//20200306231847

:25D::PROC//COMP

:16R:LINK

:13A::LINK//564

:20C::PREV//CS20481700
:16S:LINK
:16S:GENL
:16R:USECU
:35B:ISIN AT0000A2CQT8
ERSTE OE TURBO-OS LG02/20
:16R:ACCTINFO
:97A::SAFE// OCSD123400
:94F::SAFE//CUST/OCSDATWW
:93B::ELIG//UNIT/1000,
:93B::SETT//UNIT/1000,
:16S:ACCTINFO
:16S:USECU
:16R:CADETL
:98A::XDTE//20200309
:98A::RDTE//20200306
:16S:CADETL
:16R:CAOPTN
:13A::CAON//001
:22F::CAOP//CASH
:11A::OPTN//EUR
:17B::DFLT//Y
:16R:SECMOVE
:22H::CRDB//DEBT
:35B:ISIN AT0000A2CQT8
ERSTE OE TURBO-OS LG02/20

:36B::ENTL//UNIT/1000,
:98A::PAYD//20200309
:16S:SECMOVE
:16R:CASHMOVE
:22H::CRDB//CRED
:97A::CASH// CATEURXYZAATWWXXXMUSTER1
:19B::ENTL//EUR50,
:19B::GRSS//EUR50,
:19B::NETT//EUR50,
:98A::PAYD//20200309
:90B::OFFR//ACTU/EUR0,05
:16S:CASHMOVE
:16S:CAOPTN
:16R:ADDINFO
:70E::ADTX//Direct payment as per your
instruction - no processing of
credit payments by OeKB CSD.
:16S:ADDINFO

2.3.6.3 EXWA MAND – MT566

:16R:GENL
:20C::CORP//EXWAM00040218
:20C::SEME//CS20585210
:20C::COAF//ATEXWAM00040218
:23G:NEWM
:22F::CAEV//EXWA
:98C::PREP//20200309121852

:16R:LINK

:13A::LINK//564

:20C::PREV//CS20564070

:16S:LINK

:16R:LINK

:13B::LINK//sese.025.001.07

:20C::RELA//CS000777501

:16S:LINK

:16S:GENL

:16R:USECU

:97A::SAFE// OCSD123400

:35B:ISIN AT0000A2CQT8

ERSTE OE TURBO-OS LG02/20

:93B::CONB//UNIT/1000,

:16S:USECU

:16R:CADETL

:98A::XDTE//20200309

:98A::RDTE//20200306

:16S:CADETL

:16R:CACONF

:13A::CAON//001

:22F::CAOP//CASH

:16R:SECMOVE

:22H::CRDB//DEBT

:35B:ISIN AT0000A2CQT8

ERSTE OE TURBO-OS LG02/20

:36B::PSTA//UNIT/1000,

:98A::POST//20200309

:98A::PAYD//20200309

:16S:SECMOVE

:16S:CACONF

:16R:ADDINFO

:70E::ADTX//Direct payment as per your

instruction - no processing of

credit payments by OeKB CSD.

:16S:ADDINFO

2.3.7 EXWA - Warrant Exercise

2.3.7.1 EXWA MAND – MT564 NEWM

:16R:GENL

:20C::CORP//EXWAM00040209

:20C::SEME//CS20481780

:20C::COAF//ATEXWAM00040209

:23G:NEWM

:22F::CAEV//EXWA

:22F::CAMV//MAND

:98C::PREP//20200302161613

:25D::PROC//COMP

:16S:GENL

:16R:USECU

:35B:ISIN AT0000A1QMF8

ERSTE OE TURBO-OS LG01/17

:16R:ACCTINFO

:97A::SAFE// OCSD123400
:94F::SAFE//CUST/OCSDATWW
:93B::ELIG//UNIT/20000,
:93B::SETT//UNIT/20000,
:16S:ACCTINFO
:16S:USECU
:16R:CADETL
:98A::XDTE//20200309
:98A::RDTE//20200306
:16S:CADETL
:16R:CAOPTN
:13A::CAON//001
:22F::CAOP//CASH
:11A::OPTN//EUR
:17B::DFLT//Y
:16R:SECMOVE
:22H::CRDB//DEBT
:35B:ISIN AT0000A1QMF8
ERSTE OE TURBO-OS LG01/17
:98A::PAYD//20200309
:16S:SECMOVE
:16R:CASHMOVE
:22H::CRDB//CRED
:98A::PAYD//20200309
:90B::OFFR//ACTU/EUR0,1
:16S:CASHMOVE

:16S:CAOPTN

2.3.7.2 EXWA MAND – MT564 REPE

:16R:GENL

:20C::CORP//EXWAM00040209

:20C::SEME//CS20562130

:20C::COAF//ATEXWAM00040209

:23G:REPE

:22F::CAEV//EXWA

:22F::CAMV//MAND

:98C::PREP//20200306231739

:25D::PROC//COMP

:16R:LINK

:13A::LINK//564

:20C::PREV//CS20481780

:16S:LINK

:16S:GENL

:16R:USECU

:35B:ISIN AT0000A1QMF8

ERSTE OE TURBO-OS LG01/17

:16R:ACCTINFO

:97A::SAFE// OCSD123400

:94F::SAFE//CUST/OCSDATWW

:93B::ELIG//UNIT/20000,

:93B::SETT//UNIT/20000,

:16S:ACCTINFO

:16S:USECU

:16R:CADETL
:98A::XDTE//20200309
:98A::RDTE//20200306
:16S:CADETL
:16R:CAOPTN
:13A::CAON//001
:22F::CAOP//CASH
:11A::OPTN//EUR
:17B::DFLT//Y
:16R:SECMOVE
:22H::CRDB//DEBT
:35B:ISIN AT0000A1QMF8
ERSTE OE TURBO-OS LG01/17
:36B::ENTL//UNIT/20000,
:98A::PAYD//20200309
:16S:SECMOVE
:16R:CASHMOVE
:22H::CRDB//CRED
:97A::CASH// CATEURXYZAATWWXXXMUSTER1
:19B::ENTL//EUR2000,
:19B::GRSS//EUR2000,
:19B::NETT//EUR2000,
:98A::PAYD//20200309
:90B::OFFR//ACTU/EUR0,1
:16S:CASHMOVE
:16S:CAOPTN

2.3.7.3 EXWA MAND – MT566 NEWM

:16R:GENL

:20C::CORP//EXWAM00040209

:20C::SEME//CS20585120

:20C::COAF//ATEXWAM00040209

:23G:NEWM

:22F::CAEV//EXWA

:98C::PREP//20200309121850

:16R:LINK

:13A::LINK//564

:20C::PREV//CS20562130

:16S:LINK

:16R:LINK

:13B::LINK//sese.025.001.07

:20C::RELA//CS000778051

:16S:LINK

:16S:GENL

:16R:USECU

:97A::SAFE// OCSD123400

:35B:ISIN AT0000A1QMF8

ERSTE OE TURBO-OS LG01/17

:93B::CONB//UNIT/20000,

:16S:USECU

:16R:CADETL

:98A::XDTE//20200309

:98A::RDTE//20200306

:16S:CADETL

:16R:CACONF
:13A::CAON//001
:22F::CAOP//CASH
:16R:SECMOVE
:22H::CRDB//DEBT
:35B:ISIN AT0000A1QMF8
ERSTE OE TURBO-OS LG01/17
:36B::PSTA//UNIT/20000,
:98A::POST//20200309
:98A::PAYD//20200309
:16S:SECMOVE
:16R:CASHMOVE
:22H::CRDB//CRED
:97A::CASH// CATEURXYZAATWWXXXMUSTER1
:19B::PSTA//EUR2000,
:19B::GRSS//EUR2000,
:19B::NETT//EUR2000,
:98A::POST//20200309
:98A::VALU//20200309
:98A::PAYD//20200309
:90B::OFFR//ACTU/EUR0,1
:16S:CASHMOVE
:16S:CACONF

2.3.8 PCAL – Partial Redemption without Pool Factor Reduction

2.3.8.1 PCAL MAND – MT564 NEWM

:16R:GENL

:20C::CORP//PCAL00015102
:20C::SEME//CS20240740
:20C::COAF//ATPCAL00015102
:23G::NEWM
:22F::CAEV//PCAL
:22F::CAMV//MAND
:98C::PREP//20200210181629
:25D::PROC//COMP
:16S::GENL
:16R::USECU
:35B::ISIN AT0000A153X1
JP IMM INV ZWEI SCHV14-24
:16R::FIA
:11A::DENO//EUR
:98A::MATU//20240228
:16S::FIA
:16R::ACCTINFO
:97A::SAFE// OCSD123400
:94F::SAFE//CUST/OCSDATWW
:93B::ELIG//FAMT/10000000,
:93B::SETT//FAMT/10000000,
:16S::ACCTINFO
:16S::USECU
:16R::CADETL
:98A::XDTE//20200228
:98A::RDTE//20200227

:16S:CADETL

:16R:CAOPTN

:13A::CAON//001

:22F::CAOP//CASH

:11A::OPTN//EUR

:17B::DFLT//Y

:16R:SECMOVE

:22H::CRDB//DEBT

:35B:ISIN AT0000A153X1

JP IMM INV ZWEI SCHV14-24

:98A::PAYD//20200228

:16S:SECMOVE

:16R:CASHMOVE

:22H::CRDB//CRED

:98A::PAYD//20200228

:90A::OFFR//PRCT/100,

:16S:CASHMOVE

:16S:CAOPTN

2.3.8.2 PCAL MAND – MT564 REPL incl. unknown Rate

:16R:GENL

:20C::CORP//PCAL00015102

:20C::SEME//CS20261270

:20C::COAF//ATPCAL00015102

:23G:REPL

:22F::CAEV//PCAL

:22F::CAMV//MAND

:98C::PREP//20200212141542

:25D::PROC//COMP

:16R:LINK

:13A::LINK//564

:20C::PREV//CS20240740

:16S:LINK

:16S:GENL

:16R:USECU

:35B:ISIN AT0000A153X1

JP IMM INV ZWEI SCHV14-24

:16R:FIA

:11A::DENO//EUR

:98A::MATU//20240228

:16S:FIA

:16R:ACCTINFO

:97A::SAFE// OCSD123400

:94F::SAFE//CUST/OCSDATWW

:93B::ELIG//FAMT/10000000,

:93B::SETT//FAMT/10000000,

:16S:ACCTINFO

:16S:USECU

:16R:CADETL

:98A::XDTE//20200228

:98A::RDTE//20200227

:16S:CADETL

:16R:CAOPTN

:13A::CAON//001

:22F::CAOP//CASH

:11A::OPTN//EUR

:17B::DFLT//Y

:16R::SECMOVE

:22H::CRDB//DEBT

:35B::ISIN AT0000A153X1

JP IMM INV ZWEI SCHV14-24

:98A::PAYD//20200228

:16S::SECMOVE

:16R::CASHMOVE

:22H::CRDB//CRED

:98A::PAYD//20200228

:92K::RATE//UKWN

:90A::OFFR//PRCT/100,

:16S::CASHMOVE

:16S::CAOPTN

2.3.8.3 PCAL MAND – MT564 REPL Rate already known

:16R::GENL

:20C::CORP//PCAL00015102

:20C::SEME//CS20418240

:20C::COAF//ATPCAL00015102

:23G::REPL

:22F::CAEV//PCAL

:22F::CAMV//MAND

:98C::PREP//20200227091608

:25D::PROC//COMP

:16R:LINK

:13A::LINK//564

:20C::PREV//CS20261270

:16S:LINK

:16S:GENL

:16R:USECU

:35B:ISIN AT0000A153X1

JP IMM INV ZWEI SCHV14-24

:16R:FIA

:11A::DENO//EUR

:98A::MATU//20240228

:16S:FIA

:16R:ACCTINFO

:97A::SAFE// OCSD123400

:94F::SAFE//CUST/OCSDATWW

:93B::ELIG//FAMT/10000000,

:93B::SETT//FAMT/10000000,

:16S:ACCTINFO

:16S:USECU

:16R:CADETL

:98A::XDTE//20200228

:98A::RDTE//20200227

:16S:CADETL

:16R:CAOPTN

:13A::CAON//001

:22F::CAOP//CASH

:11A::OPTN//EUR

:17B::DFLT//Y

:16R::SECMOVE

:22H::CRDB//DEBT

:35B::ISIN AT0000A153X1

JP IMM INV ZWEI SCHV14-24

:98A::PAYD//20200228

:16S::SECMOVE

:16R::CASHMOVE

:22H::CRDB//CRED

:98A::PAYD//20200228

:92A::RATE//0,823

:90A::OFFR//PRCT/100,

:16S::CASHMOVE

:16S::CAOPTN

2.3.8.4 PCAL MAND – MT564 REPE

:16R::GENL

:20C::CORP//PCAL00015102

:20C::SEME//CS20428360

:20C::COAF//ATPCAL00015102

:23G::REPE

:22F::CAEV//PCAL

:22F::CAMV//MAND

:98C::PREP//20200227231725

:25D::PROC//COMP

:16R:LINK

:13A::LINK//564

:20C::PREV//CS20418240

:16S:LINK

:16S:GENL

:16R:USECU

:35B:ISIN AT0000A153X1

JP IMM INV ZWEI SCHV14-24

:16R:FIA

:11A::DENO//EUR

:98A::MATU//20240228

:16S:FIA

:16R:ACCTINFO

:97A::SAFE// OCSD123400

:94F::SAFE//CUST/OCSDATWW

:93B::ELIG//FAMT/10000000,

:93B::SETT//FAMT/10000000,

:16S:ACCTINFO

:16S:USECU

:16R:CADETL

:98A::XDTE//20200228

:98A::RDTE//20200227

:16S:CADETL

:16R:CAOPTN

:13A::CAON//001

:22F::CAOP//CASH

:11A::OPTN//EUR
:17B::DFLT//Y
:16R:SECMOVE
:22H::CRDB//DEBT
:35B:ISIN AT0000A153X1
JP IMM INV ZWEI SCHV14-24
:36B::ENTL//FAMT/82300,
:98A::PAYD//20200228
:16S:SECMOVE
:16R:CASHMOVE
:22H::CRDB//CRED
:97A::CASH// CATEURXYZAATWWXXXMUSTER1
:19B::ENTL//EUR82300,
:19B::GRSS//EUR82300,
:19B::NETT//EUR82300,
:98A::PAYD//20200228
:92A::RATE//0,823
:90A::OFFR//PRCT/100,
:16S:CASHMOVE
:16S:CAOPTN

2.3.8.5 PCAL MAND – MT566 NEWM

:16R:GENL
:20C::CORP//PCAL00015102
:20C::SEME//CS20443120
:20C::COAF//ATPCAL00015102
:23G:NEWM

:22F::CAEV//PCAL
:98C::PREP//20200228121803
:16R:LINK
:13A::LINK//564
:20C::PREV//CS20428360
:16S:LINK
:16R:LINK
:13B::LINK//sese.025.001.07
:20C::RELA//CS000772156
:16S:LINK
:16S:GENL
:16R:USECU
:97A::SAFE// OCSD123400
:35B:ISIN AT0000A153X1
JP IMM INV ZWEI SCHV14-24
:16R:FIA
:11A::DENO//EUR
:98A::MATU//20240228
:16S:FIA
:93B::CONB//FAMT/10000000,
:16S:USECU
:16R:CADETL
:98A::XDTE//20200228
:98A::RDTE//20200227
:16S:CADETL
:16R:CACONF

:13A::CAON//001
:22F::CAOP//CASH
:16R:SECMOVE
:22H::CRDB//DEBT
:35B:ISIN AT0000A153X1
JP IMM INV ZWEI SCHV14-24
:36B::PSTA//FAMT/82300,
:98A::POST//20200228
:98A::PAYD//20200228
:16S:SECMOVE
:16R:CASHMOVE
:22H::CRDB//CRED
:97A::CASH// CATEURXYZAATWWXXXMUSTER1
:19B::PSTA//EUR82300,
:19B::GRSS//EUR82300,
:19B::NETT//EUR82300,
:98A::POST//20200228
:98A::VALU//20200228
:98A::PAYD//20200228
:92A::RATE//0,823
:90A::OFFR//PRCT/100,
:16S:CASHMOVE
:16S:CACONF

2.3.9 WRTH – Worthless with Domestic ISIN

2.3.9.1 WRTH MAND – MT564 NEWM

:16R:GENL

:20C::CORP//WRTH00009303
:20C::SEME//CS19687290
:20C::COAF//ATWRTH00009303
:23G:NEWM
:22F::CAEV//WRTH
:22F::CAMV//MAND
:98C::PREP//20191223182143
:25D::PROC//COMP
:16S:GENL
:16R:USECU
:35B:ISIN AT0000A20WS9
RCB DISC ZERT 04/18
:16R:FIA
:98A::MATU//20191227
:16S:FIA
:16R:ACCTINFO
:97A::SAFE// OCSD123400
:94F::SAFE//CUST/OCSDATWW
:93B::ELIG//UNIT/1,
:93B::SETT//UNIT/1,
:16S:ACCTINFO
:16S:USECU
:16R:CADETL
:98A::XDTE//20191227
:98A::RDTE//20191224
:16S:CADETL

:16R:CAOPTN

:13A::CAON//001

:22F::CAOP//LAPS

:17B::DFLT//Y

:16R:SECMOVE

:22H::CRDB//DEBT

:35B:ISIN AT0000A20WS9

RCB DISC ZERT 04/18

:98A::PAYD//20191227

:16S:SECMOVE

:16S:CAOPTN

2.3.9.2 WRTH MAND – MT564 REPE

:16R:GENL

:20C::CORP//WRTH00009303

:20C::SEME//CS19696810

:20C::COAF//ATWRTH00009303

:23G:REPE

:22F::CAEV//WRTH

:22F::CAMV//MAND

:98C::PREP//20191224231634

:25D::PROC//COMP

:16R:LINK

:13A::LINK//564

:20C::PREV//CS19687290

:16S:LINK

:16S:GENL

:16R:USECU

:35B:ISIN AT0000A20WS9

RCB DISC ZERT 04/18

:16R:FIA

:98A::MATU//20191227

:16S:FIA

:16R:ACCTINFO

:97A::SAFE// OCSD123400

:94F::SAFE//CUST/OCSDATWW

:93B::ELIG//UNIT/1,

:93B::SETT//UNIT/1,

:16S:ACCTINFO

:16S:USECU

:16R:CADETL

:98A::XDTE//20191227

:98A::RDTE//20191224

:16S:CADETL

:16R:CAOPTN

:13A::CAON//001

:22F::CAOP//LAPS

:17B::DFLT//Y

:16R:SECMOVE

:22H::CRDB//DEBT

:35B:ISIN AT0000A20WS9

RCB DISC ZERT 04/18

:36B::ENTL//UNIT/1,

:98A::PAYD//20191227

:16S:SECMOVE

:16S:CAOPTN

2.3.9.3 WRTH MAND – MT566 NEWM

:16R:GENL

:20C::CORP//WRTH00009303

:20C::SEME//CS19712260

:20C::COAF//ATWRTH00009303

:23G:NEWM

:22F::CAEV//WRTH

:98C::PREP//20191227073547

:16R:LINK

:13A::LINK//564

:20C::PREV//CS19696810

:16S:LINK

:16R:LINK

:13B::LINK//sese.025.001.07

:20C::RELA//CS000736777

:16S:LINK

:16S:GENL

:16R:USECU

:97A::SAFE// OCSD123400

:35B:ISIN AT0000A20WS9

RCB DISC ZERT 04/18

:16R:FIA

:98A::MATU//20191227

:16S:FIA

:93B::CONB//UNIT/1,

:16S:USECU

:16R:CADETL

:98A::XDTE//20191227

:98A::RDTE//20191224

:16S:CADETL

:16R:CACONF

:13A::CAON//001

:22F::CAOP//LAPS

:16R:SECMOVE

:22H::CRDB//DEBT

:35B:ISIN AT0000A20WS9

RCB DISC ZERT 04/18

:36B::PSTA//UNIT/1,

:98A::POST//20191227

:98A::PAYD//20191227

:16S:SECMOVE

:16S:CACONF

2.3.10 PRED - Partial Redemption with Pool Factor Reduction Domestic ISIN

2.3.10.1 PRED MAND – MT564 NEWM

:16R:GENL

:20C::CORP//PRED00000736

:20C::SEME//CS20123810

:20C::COAF//ATPRED00000736

:23G:NEWM

:22F::CAEV//PRED
:22F::CAMV//MAND
:98C::PREP//20200131091624
:25D::PROC//PREC
:16S:GENL
:16R:USECU
:35B:ISIN AT000B051487
VA KRG BKSCHVII15-21
:16R:FIA
:11A::DENO//EUR
:98A::MATU//20210320
:16S:FIA
:16R:ACCTINFO
:97A::SAFE// OCSD123400
:94F::SAFE//CUST/OCSDATWW
:93B::ELIG//FAMT/190000,
:93B::SETT//FAMT/190000,
:16S:ACCTINFO
:16S:USECU
:16R:CADETL
:98A::XDTE//20200220
:98A::RDTE//20200219
:92A::NWFC//0,46
:92A::PRFC//0,47
:16S:CADETL
:16R:CAOPTN

:13A::CAON//001

:22F::CAOP//CASH

:11A::OPTN//EUR

:17B::DFLT//Y

:16R::CASHMOVE

:22H::CRDB//CRED

:98A::PAYD//20200220

:92A::RATE//1,

:90A::OFFR//PRCT/100,

:16S::CASHMOVE

:16S::CAOPTN

2.3.10.2 PRED MAND – MT564 REPE

:16R::GENL

:20C::CORP//PRED00000736

:20C::SEME//CS20343030

:20C::COAF//ATPRED00000736

:23G::REPE

:22F::CAEV//PRED

:22F::CAMV//MAND

:98C::PREP//20200219231707

:25D::PROC//COMP

:16R::LINK

:13A::LINK//564

:20C::PREV//CS20123810

:16S::LINK

:16S::GENL

:16R:USECU

:35B:ISIN AT000B051487

VA KRG BKSCHVII15-21

:16R:FIA

:11A::DENO//EUR

:98A::MATU//20210320

:16S:FIA

:16R:ACCTINFO

:97A::SAFE// OCSD123400

:94F::SAFE//CUST/OCSDATWW

:93B::ELIG//FAMT/190000,

:93B::SETT//FAMT/190000,

:16S:ACCTINFO

:16S:USECU

:16R:CADETL

:98A::XDTE//20200220

:98A::RDTE//20200219

:92A::NWFC//0,46

:92A::PRFC//0,47

:16S:CADETL

:16R:CAOPTN

:13A::CAON//001

:22F::CAOP//CASH

:11A::OPTN//EUR

:17B::DFLT//Y

:16R:CASHMOVE

:22H::CRDB//CRED

:97A::CASH// CATEURXYZAATWWXXXMUSTER1

:19B::ENTL//EUR1900,

:19B::GRSS//EUR1900,

:19B::NETT//EUR1900,

:98A::PAYD//20200220

:92A::RATE//1,

:90A::OFFR//PRCT/100,

:16S:CASHMOVE

:16S:CAOPTN

2.3.10.3 PRED MAND – MT566 NEWM

:16R:GENL

:20C::CORP//PRED00000736

:20C::SEME//CS20352820

:20C::COAF//ATPRED00000736

:23G:NEWM

:22F::CAEV//PRED

:98C::PREP//20200220121554

:16R:LINK

:13A::LINK//564

:20C::PREV//CS20343040

:16S:LINK

:16R:LINK

:13B::LINK//sese.025.001.07

:20C::RELA//CS000768997

:16S:LINK

:16S:GENL
:16R:USECU
:97A::SAFE//OCSD123400
:35B:ISIN AT000B051487
VA KRG BKSCHVII15-21
:16R:FIA
:11A::DENO//EUR
:98A::MATU//20210320
:16S:FIA
:93B::CONB//FAMT/2378000,
:16S:USECU
:16R:CADETL
:98A::XDTE//20200220
:98A::RDTE//20200219
:92A::NWFC//0,46
:92A::PRFC//0,47
:16S:CADETL
:16R:CACONF
:13A::CAON//001
:22F::CAOP//CASH
:16R:CASHMOVE
:22H::CRDB//CRED
:97A::CASH// CATEURXYZAATWWXXXMUSTER1
:19B::PSTA//EUR23780,
:19B::GRSS//EUR23780,
:19B::NETT//EUR23780,

:98A::POST//20200220

:98A::VALU//20200220

:98A::PAYD//20200220

:92A::RATE//1,

:90A::OFFR//PRCT/100,

:16S:CASHMOVE

:16S:CACONF

2.3.11 SHPR - Shares Premium Dividend for Domestic ISIN

2.3.11.1 SHPR MAND – MT564 NEWM

:16R:GENL

:20C::CORP//SHPR00010301

:20C::SEME//CS16954630

:20C::COAF//ATSHPR00010301

:23G:NEWM

:22F::CAEV//SHPR

:22F::CAMV//MAND

:98C::PREP//20190527151641

:25D::PROC//COMP

:16S:GENL

:16R:USECU

:35B:ISIN AT0000827209

WARIMPEX FINANZ AKT O.N.

:16R:ACCTINFO

:97A::SAFE// OCSD123400

:94F::SAFE//CUST/OCSDATWW

:93B::ELIG//UNIT/1500,

:93B::SETT//UNIT/1500,

:16S:ACCTINFO

:16S:USECU

:16R:CADETL

:98A::XDTE//20190606

:98A::RDTE//20190607

:22F::DIVI//REGR

:16S:CADETL

:16R:CAOPTN

:13A::CAON//001

:22F::CAOP//CASH

:11A::OPTN//EUR

:17B::DFLT//Y

:16R:CASHMOVE

:22H::CRDB//CRED

:98A::PAYD//20190612

:92F::GRSS//EUR0,06

:16S:CASHMOVE

:16S:CAOPTN

2.3.11.2 SHPR MAND – MT564 REPE

:16R:GENL

:20C::CORP//SHPR00010301

:20C::SEME//CS17158340

:20C::COAF//ATSHPR00010301

:23G:REPE

:22F::CAEV//SHPR

:22F::CAMV//MAND
:98C::PREP//20190608001609
:25D::PROC//COMP
:16R:LINK
:13A::LINK//564
:20C::PREV//CS16954630
:16S:LINK
:16S:GENL
:16R:USECU
:35B:ISIN AT0000827209
WARIMPEX FINANZ AKT O.N.
:16R:ACCTINFO
:97A::SAFE// OCSD123400
:94F::SAFE//CUST/OCSDATWW
:93B::ELIG//UNIT/1500,
:93B::SETT//UNIT/1500,
:16S:ACCTINFO
:16S:USECU
:16R:CADETL
:98A::XDTE//20190606
:98A::RDTE//20190607
:22F::DIVI//REGR
:16S:CADETL
:16R:CAOPTN
:13A::CAON//001
:22F::CAOP//CASH

:11A::OPTN//EUR

:17B::DFLT//Y

:16R:CASHMOVE

:22H::CRDB//CRED

:97A::CASH// CATEURXYZAATWWXXXMUSTER1

:19B::ENTL//EUR90,

:19B::GRSS//EUR90,

:19B::NETT//EUR90,

:98A::PAYD//20190612

:92F::GRSS//EUR0,06

:16S:CASHMOVE

:16S:CAOPTN

2.3.12 SHPR MAND – MT566 NEWM

:16R:GENL

:20C::CORP//SHPR00010301

:20C::SEME//CS17212530

:20C::COAF//ATSHPR00010301

:23G:NEWM

:22F::CAEV//SHPR

:98C::PREP//20190612121628

:16R:LINK

:13A::LINK//564

:20C::PREV//CS17158340

:16S:LINK

:16R:LINK

:13B::LINK//sese.025.001.07

:20C::RELA//CS000629122
:16S:LINK
:16S:GENL
:16R:USECU
:97A::SAFE// OCSD123400
:35B:ISIN AT0000827209
WARIMPEX FINANZ AKT O.N.
:93B::CONB//UNIT/1500,
:16S:USECU
:16R:CADETL
:98A::XDTE//20190606
:98A::RDTE//20190607
:16S:CADETL
:16R:CACONF
:13A::CAON//001
:22F::CAOP//CASH
:16R:CASHMOVE
:22H::CRDB//CRED
:97A::CASH// CATEURXYZAATWWXXXMUSTER1
:19B::PSTA//EUR90,
:19B::GRSS//EUR90,
:19B::NETT//EUR90,
:98A::POST//20190612
:98A::VALU//20190612
:98A::PAYD//20190612
:90B::OFFR//ACTU/EUR0,06

:16S:CASHMOVE

:16S:CACONF

2.4 Corporate Action SWIFT Examples (SWIFT ISO 15022)

2.4.1 MEET - Meeting

2.4.1.1 MEET VOLU – MT564 NEWM

:16R:GENL

:20C::CORP//MEET00000001

:20C::SEME//CS13995670

:23G:NEWM

:22F::CAEV//MEET

:22F::CAMV//VOLU

:98C::PREP//20181010091624

:25D::PROC//COMP

:16S:GENL

:16R:USECU

:35B:ISIN IT00000SHARE

SAMPLE SHARE

:16R:ACCTINFO

:97A::SAFE// OCSD123400

:94F::SAFE//CUST/DAKVDEFF

:93B::ELIG//UNIT/342,

:93B::SETT//UNIT/342,

:93B::UNBA//UNIT/342,

:16S:ACCTINFO

:16S:USECU

:16R:CADETL
:98A::ANOU//20180921
:98C::MEET//20181027100000
:98A::RDTE//20181018
:94E::MEET//Via Filodrammatici 3, Milan, Italy
:16S:CADETL
:16R:CAOPTN
:13A::CAON//001
:22F::CAOP//CONY
:22F::OPTF//BOIS
:17B::DFLT//N
:98C::RDDT//20181019173000
:16S:CAOPTN
:16R:CAOPTN
:13A::CAON//002
:22F::CAOP//CONN
:22F::OPTF//BOIS
:17B::DFLT//N
:98C::RDDT//20181019173000
:16S:CAOPTN
:16R:CAOPTN
:13A::CAON//003
:22F::CAOP//ABST
:22F::OPTF//BOIS
:17B::DFLT//N
:98C::RDDT//20181019173000

:16S:CAOPTN

:16R:CAOPTN

:13A::CAON//004

:22F::CAOP//SPLI

:22F::OPTF//BOIS

:17B::DFLT//N

:98C::RDDT//20181019173000

:16S:CAOPTN

:16R:CAOPTN

:13A::CAON//005

:22F::CAOP//PROX

:22F::OPTF//BOIS

:17B::DFLT//N

:98C::RDDT//20181019173000

:16S:CAOPTN

:16R:CAOPTN

:13A::CAON//006

:22F::CAOP//NOAC

:17B::DFLT//Y

:16S:CAOPTN

:16R:ADDINFO

:70E::ADTX//1. Approve Financial Statements,

Statutory Reports, and Allocation

of Income (For, Against, Abstain,

Do Not Vote) 2. Elect Maximo

Ibarra and Vittorio

Pignatti-Morano Campori as
Directors (Bundled) (For, Against,
Abstain, Do Not Vote) 3.a. Approve
Remuneration Policy (For, Against,
Abstain, Do Not
:70E::ADTX//Vote) 3.b. Approve Fixed-Variable
Compensation Ratio (For, Against,
Abstain, Do Not Vote) 3.c. Approve
Severance Payments Policy (For,
Against, Abstain, Do Not Vote) 4.
Authorize Share Repurchase Program
and Reissuance of Repurchased
Shares (For, Against,
:70E::ADTX//Abstain, Do Not Vote) Blocking. No
Country. IT Partial Vote. Yes .

:16S:ADDINFO

2.4.2 LIQU – Liquidation

2.4.2.1 LIQU MAND – MT564 NEWM

:16R:GENL

:20C::CORP//LIQU00027705

:20C::SEME//CS9975490

:20C::COAF//ATLIQU00027705

:23G:NEWM

:22F::CAEV//LIQU

:22F::CAMV//MAND

:98C::PREP//20190416125117

:25D::PROC//COMP

:16S:GENL

:16R:USECU

:35B:ISIN AT0000FUND00

SAMPLE FUND SHARE

:16R:ACCTINFO

:97A::SAFE// OCSD123400

:94F::SAFE//CUST/OCSDATWW

:93B::ELIG//UNIT/391924,

:93B::SETT//UNIT/391924,

:16S:ACCTINFO

:16S:USECU

:16R:CADETL

:98A::XDTE//20190416

:16S:CADETL

:16R:CAOPTN

:13A::CAON//001

:22F::CAOP//CASH

:11A::OPTN//EUR

:17B::DFLT//Y

:16R:SECMOVE

:22H::CRDB//DEBT

:35B:ISIN AT0000 FUND00

SAMPLE FUND SHARE

:98A::PAYD//20190416

:16S:SECMOVE

:16R:CASHMOVE

:22H::CRDB//CRED

:98A::PAYD//20190416

:90B::OFFR//ACTU/EUR0,08899

:16S:CASHMOVE

:16S:CAOPTN

2.4.2.2 LIQU MAND – MT564 REPE

:16R:GENL

:20C::CORP//LIQU00027705

:20C::SEME//CS9975560

:20C::COAF//ATLIQU00027705

:23G:REPE

:22F::CAEV//LIQU

:22F::CAMV//MAND

:98C::PREP//20190416125517

:25D::PROC//COMP

:16R:LINK

:13A::LINK//564

:20C::PREV//CS9975500

:16S:LINK

:16S:GENL

:16R:USECU

:35B:ISIN AT0000 FUND00

SAMPLE FUND SHARE

:16R:ACCTINFO

:97A::SAFE// OCSD123400

:94F::SAFE//CUST/OCSDATWW
:93B::ELIG//UNIT/11586,
:93B::SETT//UNIT/11586,
:16S:ACCTINFO
:16S:USECU
:16R:CADETL
:98A::XDTE//20190416
:16S:CADETL
:16R:CAOPTN
:13A::CAON//001
:22F::CAOP//CASH
:11A::OPTN//EUR
:17B::DFLT//Y
:16R:SECMOVE
:22H::CRDB//DEBT
:35B:ISIN AT0000 FUND00
SAMPLE FUND SHARE
:36B::ENTL//UNIT/11586,
:98A::PAYD//20190416
:16S:SECMOVE
:16R:CASHMOVE
:22H::CRDB//CRED
:97A::CASH// CATEURXYZAATWWXXXMUSTER1
:19B::ENTL//EUR1031,04
:19B::GRSS//EUR1031,04
:19B::NETT//EUR1031,04

:98A::PAYD//20190416

:90B::OFFR//ACTU/EUR0,08899

:16S:CASHMOVE

:16S:CAOPTN

2.4.2.3 LIQU MAND – MT566 NEWM

:16R:GENL

:20C::CORP//LIQU00028201

:20C::SEME//CS19313920

:20C::COAF//ATLIQU00028201

:23G:NEWM

:22F::CAEV//LIQU

:98C::PREP//20191127121657

:16R:LINK

:13A::LINK//564

:20C::PREV//CS19295330

:16S:LINK

:16R:LINK

:13B::LINK//sese.025.001.07

:20C::RELA//CS000721550

:16S:LINK

:16S:GENL

:16R:USECU

:97A::SAFE// OCSD123400

:35B:ISIN AT0000 FUND00

SAMPLE FUND SHARE

:16R:FIA

:98A::MATU//20191120

:16S:FIA

:93B::CONB//UNIT/35048,

:16S:USECU

:16R:CADETL

:98A::XDTE//20191120

:16S:CADETL

:16R:CACONF

:13A::CAON//001

:22F::CAOP//CASH

:16R:CASHMOVE

:22H::CRDB//CRED

:97A::CASH// CATEURXYZAATWWXXXMUSTER1

:19B::PSTA//EUR42828638,48

:19B::GRSS//EUR42828638,48

:19B::NETT//EUR42828638,48

:98A::POST//20191127

:98A::VALU//20191127

:98A::PAYD//20191127

:90B::OFFR//ACTU/EUR1221,9995

:16S:CASHMOVE

:16S:CACONF

2.4.2.4 LIQU MAND – MT566 REVR

:16R:GENL

:20C::CORP//LIQU00028201

:20C::SEME//CS19314000

:20C::COAF//ATLIQU00028201

:23G:REVR

:22F::CAEV//LIQU

:98C::PREP//20191127130451

:16R:LINK

:13A::LINK//566

:20C::PREV//CS19313920

:16S:LINK

:16R:LINK

:13B::LINK//sese.025.001.07

:20C::RELA//CS000721553

:16S:LINK

:16S:GENL

:16R:USECU

:97A::SAFE// OCSD123400

:35B:ISIN AT0000 FUND00

SAMPLE FUND SHARE:16R:FIA

:98A::MATU//20191120

:16S:FIA

:93B::CONB//UNIT/35048,

:16S:USECU

:16R:CADETL

:98A::XDTE//20191120

:16S:CADETL

:16R:CACONF

:13A::CAON//001

:22F::CAOP//CASH
:16R:CASHMOVE
:22H::CRDB//CRED
:97A::CASH// CATEURXYZAATWWXXXMUSTER1
:19B::PSTA//EUR42828638,48
:19B::GRSS//EUR42828638,48
:19B::NETT//EUR42828638,48
:98A::POST//20191127
:98A::VALU//20191127
:98A::PAYD//20191127
:90B::OFFR//ACTU/EUR1221,9995
:16S:CASHMOVE
:16S:CACONF

2.4.3 TEND – Tender Offer

2.4.3.1 TEND VOLU - MT564 NEWM

:16R:GENL
:20C::CORP//TEND00006303
:20C::SEME//CS11181540
:20C::COAF//ATTEND00006303
:23G:NEWM
:22F::CAEV//TEND
:22F::CAMV//VOLU
:98C::PREP//20200127133510
:25D::PROC//COMP
:16S:GENL
:16R:USECU

:35B:ISIN AT0000SHARE1
SAMPLE SHARE
:16R:ACCTINFO
:97A::SAFE// OCSD123400
:94F::SAFE//CUST/OCSDATWW
:93B::ELIG//UNIT/459632,53
:93B::SETT//UNIT/459632,53
:93B::UNBA//UNIT/459632,53
:16S:ACCTINFO
:16S:USECU
:16R:CAOPTN
:13A::CAON//001
:22F::CAOP//SECU
:17B::DFLT//N
:98C::MKDT//20200127180000
:98C::RDDT//20200127140000
:69A::PWAL//20200113/20200127
:16R:SECMOVE
:22H::CRDB//CRED
:35B:ISIN AT00INTERIM1
SAMPLE INTERIM SHARE
:22F::DISF//DIST
:92D::NEWO//1,/1,
:98B::PAYD// ONGO
:16S:SECMOVE
:16R:SECMOVE

:22H::CRDB//DEBT

:35B:ISIN AT0000SHARE1

SAMPLE SHARE

:98B::PAYD// ONGO

:16S:SECMOVE

:16S:CAOPTN

:16R:CAOPTN

:13A::CAON//002

:22F::CAOP//NOAC

:17B::DFLT//Y

:98C::MKDT//20200127180000

:98C::RDDT//20200127140000

:69A::PWAL//20200113/20200127

:16S:CAOPTN

:16R:ADDINFO

:95R::PAYA/OCSD/ 123400

:16S:ADDINFO

2.4.3.2 TEND VOLU - MT566 NEWM

:16R:GENL

:20C::CORP//TEND00005204

:20C::SEME//CS10711660

:20C::COAF//ATTEND00005204

:23G:NEWM

:22F::CAEV//TEND

:98C::PREP//20190917090834

:16R:LINK

:13A::LINK//564
:20C::PREV//CS10695870
:16S:LINK
:16R:LINK
:13A::LINK//565
:20C::RELA//20190917scb04
:16S:LINK
:16R:LINK
:13B::LINK//sese.025.001.07
:20C::RELA//CS000252229
:16S:LINK
:16S:GENL
:16R:USECU
:97A::SAFE// OCSD123400
:35B:ISIN AT0000SHARE1
SAMPLE SHARE
:93B::CONB//UNIT/13,
:16S:USECU
:16R:CACONF
:13A::CAON//001
:22F::CAOP//SECU
:16R:SECMOVE
:22H::CRDB//CRED
:35B:ISIN AT00INTERIM1
SAMPLE INTERIM SHARE
:36B::PSTA//UNIT/13,

:22F::DISF//DIST

:92D::NEWO//1,/1,

:98A::POST//20190917

:16S:SECMOVE

:16R:SECMOVE

:22H::CRDB//DEBT

:35B:ISIN AT0000SHARE1

SAMPLE SHARE

:36B::PSTA//UNIT/13,

:98A::POST//20190917

:16S:SECMOVE

:16S:CACONF

2.4.3.3 TEND VOLU - MT566 REVR

:16R:GENL

:20C::CORP//TEND00005204

:20C::SEME//CS10712160

:20C::COAF//ATTEND00005204

:23G:REVR

:22F::CAEV//TEND

:98C::PREP//20190917094940

:16R:LINK

:13A::LINK//566

:20C::PREV//CS10711990

:16S:LINK

:16S:GENL

:16R:USECU

:97A::SAFE// OCSD123400

:35B:ISIN AT0000SHARE1

SAMPLE SHARE

:93B::CONB//UNIT/55,

:16S:USECU

:16R:CACONF

:13A::CAON//001

:22F::CAOP//SECU

:16R:SECMOVE

:22H::CRDB//CRED

:35B:ISIN AT00INTERIM1

SAMPLE INTERIM SHARE

:36B::PSTA//UNIT/55,

:22F::DISF//DIST

:92D::NEWO//1,/1,

:98A::POST//20190917

:16S:SECMOVE

:16R:SECMOVE

:22H::CRDB//DEBT

:35B:ISIN AT0000SHARE1

SAMPLE SHARE

:36B::PSTA//UNIT/55,

:98A::POST//20190917

:16S:SECMOVE

:16S:CACONF

2.4.4 BIDS - Repurchase Offer/Issuer Bid/Reverse Rights

2.4.4.1 BIDS VOLU - MT564 NEWM

:16R:GENL

:20C::CORP//BIDS00008201

:20C::SEME//CS11269010

:23G:NEWM

:22F::CAEV//BIDS

:22F::CAMV//VOLU

:98C::PREP//20200304103550

:25D::PROC//COMP

:16S:GENL

:16R:USECU

:35B:ISIN UA0000SHARE1

SAMPLE SHARE

:16R:ACCTINFO

:97A::SAFE// OCSD123400

:94F::SAFE//CUST/BKAUATWW

:93B::ELIG//UNIT/788915,

:93B::SETT//UNIT/788915,

:93B::UNBA//UNIT/788415,

:93B::INBA//UNIT/500,

:16S:ACCTINFO

:16S:USECU

:16R:CAOPTN

:13A::CAON//001

:22F::CAOP//CASH

:11A::OPTN//UAH
:17B::DFLT//N
:98C::MKDT//20200303180000
:98C::RDDT//20200303150000
:69A::PWAL//20200102/20200303
:16R:SECMOVE
:22H::CRDB//DEBT
:35B:ISIN UA0000SHARE1
SAMPLE SHARE
:98A::PAYD//20200304
:16S:SECMOVE
:16R:CASHMOVE
:22H::CRDB//CRED
:98A::PAYD//20200304
:90B::OFFR//ACTU/UAH2,22
:16S:CASHMOVE
:16S:CAOPTN
:16R:CAOPTN
:13A::CAON//002
:22F::CAOP//NOAC
:17B::DFLT//Y
:98C::MKDT//20200303180000
:98C::RDDT//20200303150000
:69A::PWAL//20200102/20200303
:16S:CAOPTN

2.4.4.2 BIDS VOLU - MT566 NEWM

:16R:GENL

:20C::CORP//BIDS00007802

:20C::SEME//CS11189140

:23G:NEWM

:22F::CAEV//BIDS

:98C::PREP//20200130153039

:16R:LINK

:13A::LINK//564

:20C::PREV//CS11140590

:16S:LINK

:16R:LINK

:13B::LINK//sese.025.001.07

:20C::RELA//CS000271961

:16S:LINK

:16S:GENL

:16R:USECU

:97A::SAFE// OCSD123400

:35B:ISIN UA0000SHARE1

SAMPLE SHARE

:93B::CONB//UNIT/2914,

:16S:USECU

:16R:CACONF

:13A::CAON//001

:22F::CAOP//CASH

:16R:SECMOVE

:22H::CRDB//DEBT

:35B:ISIN UA0000SHARE1

SAMPLE SHARE

:36B::PSTA//UNIT/2914,

:98A::POST//20200130

:98A::PAYD//20200129

:16S:SECMOVE

:16S:CACONF

2.4.4.3 BIDS VOLU - MT566 REVR

:16R:GENL

:20C::CORP//BIDS00007802

:20C::SEME//CS11206780

:23G:REVR

:22F::CAEV//BIDS

:98C::PREP//20200206085605

:16R:LINK

:13A::LINK//566

:20C::PREV//CS11189140

:16S:LINK

:16S:GENL

:16R:USECU

:97A::SAFE// OCSD123400

:35B:ISIN UA0000SHARE1

SAMPLE SHARE

:93B::CONB//UNIT/2914,

:16S:USECU

:16R:CACONF

:13A::CAON//001

:22F::CAOP//CASH

:16R:SECMOVE

:22H::CRDB//DEBT

:35B:ISIN UA0000SHARE1

SAMPLE SHARE

:36B::PSTA//UNIT/2914,

:98A::POST//20200206

:98A::PAYD//20200129

:16S:SECMOVE

:16S:CACONF

2.4.5 DSCL - Disclosure

2.4.5.1 DSCL VOLU – MT564 NEWM

:16R:GENL

:20C::CORP//DSCL0000033102

:20C::SEME//CS11240740

:23G:NEWM

:22F::CAEV//DSCL

:22F::CAMV//VOLU

:98C::PREP//20200224130829

:25D::PROC//COMP

:16S:GENL

:16R:USECU

:35B:ISIN AT0000SHARE1

SAMPLE SHARE

:16R:ACCTINFO

:97A::SAFE// OCSD123400
:94F::SAFE//CUST/OCSDATWW
:93B::ELIG//UNIT/10480,5
:93B::SETT//UNIT/10480,5
:93B::UNBA//UNIT/10480,5
:16S:ACCTINFO
:16S:USECU
:16R:CADETL
:98A::RDTE//20191230
:16S:CADETL
:16R:CAOPTN
:13A::CAON//001
:22F::CAOP//CONY
:17B::DFLT//N
:98C::MKDT//20200305180000
:98C::RDDT//20200305100000
:69A::PWAL//20191230/20200305
:16S:CAOPTN
:16R:CAOPTN
:13A::CAON//002
:22F::CAOP//CONN
:17B::DFLT//Y
:98C::MKDT//20200305180000
:98C::RDDT//20200305100000
:69A::PWAL//20191230/20200305
:16S:CAOPTN

:16R:ADDINFO

:70E::ADTX//Narrative is needed. Beneficial owner details to be provided.

:16S:ADDINFO

2.4.5.2 DSCL VOLU – MT565 NEWM

:16R:GENL

:20C::CORP// DSCL0000033102

:20C::SEME//scb2402002

:23G:NEWM

:22F::CAEV//DSCL

:16S:GENL

:16R:USECU

:35B:ISIN AT0000SHARE1

SAMPLE SHARE

:16R:ACCTINFO

:97A::SAFE//OCSD123400

:16S:ACCTINFO

:16S:USECU

:16R:CAINST

:13A::CAON//001

:22F::CAOP//CONY

:36B::QINS//UNIT/40000,

:70E::INST//BO Details Mr. Max Mister, Samplestreet 20, 1010 Vienna, Austria,

Number of shares 40000,

:16S:CAINST

2.4.5.3 DSCL VOLU – MT567 INST (25D::IPRC//PEND)

:16R:GENL

:20C::CORP//DSCL0000033102
:20C::SEME//CS11240030
:23G:INST
:22F::CAEV//DSCL
:98C::PREP//20200224113606
:16R:LINK
:20C::RELA//scb2402002
:16S:LINK
:16R:STAT
:25D::IPRC//PEND
:16R:REAS
:24B::PEND//NARR
:70D::REAS//Narrative Received Disclosure
Needed
:16S:REAS
:16S:STAT
:16S:GENL
:16R:CADETL
:13A::CAON//001
:22H::CAOP//CONY
:97A::SAFE// OCSD123400
:35B:ISIN AT0000SHARE1
SAMPLE SHARE
:36B::STAQ//UNIT/40000,
:16S:CADETL

2.4.6 PRIO - Priority Issue

2.4.6.1 PRIO VOLU – MT564 NEWM

:16R:GENL

:20C::CORP//PRIO00001401

:20C::SEME//CS10560650

:23G:NEWM

:22F::CAEV//PRIO

:22F::CAMV//VOLU

:98C::PREP//20190905142728

:25D::PROC//COMP

:16S:GENL

:16R:USECU

:35B:ISIN GB0000SHARE1

SAMPLE SHARE

:16R:ACCTINFO

:97A::SAFE//OCSD123400

:94F::SAFE//CUST/CEDELULL

:93B::ELIG//UNIT/460,

:93B::SETT//UNIT/460,

:93B::UNBA//UNIT/460,

:16S:ACCTINFO

:16S:USECU

:16R:CADETL

:98A::RDTE//20190904

:16S:CADETL

:16R:CAOPTN

:13A::CAON//001
:22F::CAOP//SECU
:11A::OPTN//GBP
:17B::DFLT//N
:98C::MKDT//20190906150000
:98C::RDDT//20190906120000
:69A::PWAL//20190904/20190906
:36B::MIEX//UNIT/10,
:36B::MILT//UNIT/10,
:16R:SECMOVE
:22H::CRDB//CRED
:35B:ISIN GB0000SHARE1
SAMPLE SHARE
:22F::DISF//DIST
:92D::ADEX//1,/10,
:98A::PAYD//20190906
:16S:SECMOVE
:16R:CASHMOVE
:22H::CRDB//DEBT
:98A::PAYD//20190906
:90B::PRPP//ACTU/GBP0,28
:16S:CASHMOVE
:16S:CAOPTN
:16R:CAOPTN
:13A::CAON//002
:22F::CAOP//OVER

:11A::OPTN//GBP
:17B::DFLT//N
:98C::MKDT//20190906150000
:98C::RDDT//20190906120000
:69A::PWAL//20190904/20190906
:16R:SECMOVE
:22H::CRDB//CRED
:35B:ISIN GB0000SHARE1
SAMPLE SHARE
:98A::PAYD//20190906
:16S:SECMOVE
:16R:CASHMOVE
:22H::CRDB//DEBT
:98A::PAYD//20190906
:90B::PRPP//ACTU/GBP0,28
:16S:CASHMOVE
:16S:CAOPTN
:16R:CAOPTN
:13A::CAON//003
:22F::CAOP//NOAC
:17B::DFLT//Y
:98C::MKDT//20190906150000
:98C::RDDT//20190906120000
:69A::PWAL//20190904/20190906
:16S:CAOPTN

2.4.6.2 PRIO VOLU - MT564 REPL

:16R:GENL

:20C::CORP//PRIO00001401

:20C::SEME//CS10560650

:23G:REPL

:22F::CAEV//PRIO

:22F::CAMV//VOLU

:98C::PREP//20190905142728

:25D::PROC//COMP

:16R:LINK

:13A::LINK//564

:20C::PREV//CS10559190

:16S:LINK

:16S:GENL

:16R:USECU

:35B:ISIN GB0000SHARE1

SAMPLE SHARE

:16R:ACCTINFO

:97A::SAFE//OCSD123400

:94F::SAFE//CUST/CEDELULL

:93B::ELIG//UNIT/460,

:93B::SETT//UNIT/460,

:93B::UNBA//UNIT/460,

:16S:ACCTINFO

:16S:USECU

:16R:CADETL

:98A::RDTE//20190904

:16S:CADETL
:16R:CAOPTN
:13A::CAON//001
:22F::CAOP//SECU
:11A::OPTN//GBP
:17B::DFLT//N
:98C::MKDT//20190906150000
:98C::RDDT//20190906120000
:69A::PWAL//20190904/20190906
:36B::MIEX//UNIT/10,
:36B::MILT//UNIT/10,
:16R:SECMOVE
:22H::CRDB//CRED
:35B:ISIN GB0000SHARE2
SAMPLE SHARE
:22F::DISF//DIST
:92D::ADEX//1,/10,
:98A::PAYD//20190906
:16S:SECMOVE
:16R:CASHMOVE
:22H::CRDB//DEBT
:98A::PAYD//20190906
:90B::PRPP//ACTU/GBP0,28
:16S:CASHMOVE
:16S:CAOPTN
:16R:CAOPTN

:13A::CAON//002
:22F::CAOP//OVER
:11A::OPTN//GBP
:17B::DFLT//N
:98C::MKDT//20190906150000
:98C::RDDT//20190906120000
:69A::PWAL//20190904/20190906
:16R:SECMOVE
:22H::CRDB//CRED
:35B:ISIN GB0000SHARE2
SAMPLE SHARE
:98A::PAYD//20190906
:16S:SECMOVE
:16R:CASHMOVE
:22H::CRDB//DEBT
:98A::PAYD//20190906
:90B::PRPP//ACTU/GBP0,28
:16S:CASHMOVE
:16S:CAOPTN
:16R:CAOPTN
:13A::CAON//003
:22F::CAOP//NOAC
:17B::DFLT//Y
:98C::MKDT//20190906150000
:98C::RDDT//20190906120000
:69A::PWAL//20190904/20190906

:16S:CAOPTN

2.4.6.3 PRIO VOLU - MT564 RMDR

:16R:GENL

:20C::CORP//PRIO00001401

:20C::SEME//CS10566530

:23G:RMDR

:22F::CAEV//PRIO

:22F::CAMV//VOLU

:98C::PREP//20190906061755

:25D::PROC//COMP

:16R:LINK

:13A::LINK//564

:20C::PREV//CS10560650

:16S:LINK

:16S:GENL

:16R:USECU

:35B:ISIN GB0000SHARE1

SAMPLE SHARE

:16R:ACCTINFO

:97A::SAFE// OCSD123400

:94F::SAFE//CUST/CEDELULL

:93B::ELIG//UNIT/460,

:93B::SETT//UNIT/460,

:93B::UNBA//UNIT/460,

:16S:ACCTINFO

:16S:USECU

:16R:CADETL
:98A::RDTE//20190904
:16S:CADETL
:16R:CAOPTN
:13A::CAON//001
:22F::CAOP//SECU
:11A::OPTN//GBP
:17B::DFLT//N
:98C::MKDT//20190906150000
:98C::RDDT//20190906120000
:69A::PWAL//20190904/20190906
:36B::MIEX//UNIT/10,
:36B::MILT//UNIT/10,
:16R:SECMOVE
:22H::CRDB//CRED
:35B:ISIN GB0000SHARE2
SAMPLE SHARE
:22F::DISF//DIST
:92D::ADEX//1,/10,
:98A::PAYD//20190906
:16S:SECMOVE
:16R:CASHMOVE
:22H::CRDB//DEBT
:98A::PAYD//20190906
:90B::PRPP//ACTU/GBP0,28
:16S:CASHMOVE

:16S:CAOPTN
:16R:CAOPTN
:13A::CAON//002
:22F::CAOP//OVER
:11A::OPTN//GBP
:17B::DFLT//N
:98C::MKDT//20190906150000
:98C::RDDT//20190906120000
:69A::PWAL//20190904/20190906
:16R:SECMOVE
:22H::CRDB//CRED
:35B:ISIN GB0000SHARE2
SAMPLE SHARE
:98A::PAYD//20190906
:16S:SECMOVE
:16R:CASHMOVE
:22H::CRDB//DEBT
:98A::PAYD//20190906
:90B::PRPP//ACTU/GBP0,28
:16S:CASHMOVE
:16S:CAOPTN
:16R:CAOPTN
:13A::CAON//003
:22F::CAOP//NOAC
:17B::DFLT//Y
:98C::MKDT//20190906150000

:98C::RDDT//20190906120000

:69A::PWAL//20190904/20190906

:16S:CAOPTN

2.4.6.4 PRIO VOLU – MT565 NEWM – OVER Option

:16R:GENL

:20C::CORP//PRIO00001401

:20C::SEME//20190905scb09

:23G:NEWM

:22F::CAEV//PRIO

:98C::PREP//20180625155304

:16S:GENL

:16R:USECU

:35B:ISIN GB0000SHARE1

SAMPLE SHARE:16R:ACCTINFO

:97A::SAFE// OCSD123400

:16S:ACCTINFO

:16S:USECU

:16R:CAINST

:13A::CAON//002

:22F::CAOP//OVER

:36B::QINS//UNIT/100,

:70E::INST//1 client who instructed for SECU

:16S:CAINST

2.4.6.5 PRIO VOLU - MT567 INST (25D::IPRC//PEND)

:16R:GENL

:20C::CORP//PRIO00001401

:20C::SEME//CS10565520
:23G:INST
:22F::CAEV//PRIO
:98C::PREP//20190905160126
:16R:LINK
:13A::LINK//565
:20C::RELA//20190905scb09
:16S:LINK
:16R:STAT
:25D::IPRC//PEND
:16R:REAS
:24B::PEND//NARR
:70D::REAS//Narrative Received Disclosure
Needed
:16S:REAS
:16S:STAT
:16S:GENL
:16R:CADETL
:13A::CAON//002
:22H::CAOP//OVER
:97A::SAFE// OCSD123400
:35B:ISIN GB0000SHARE1
SAMPLE SHARE
:36B::STAQ//UNIT/100,
:16S:CADETL

2.4.6.6 PRIO VOLU - MT567 INST (25D::IPRC//PACK)

:16R:GENL

:20C::CORP//PRIO00001401

:20C::SEME//CS10565530

:23G:INST

:22F::CAEV//PRIO

:98C::PREP//20190905160425

:16R:LINK

:13A::LINK//565

:20C::RELA//20190905scb09

:16S:LINK

:16R:STAT

:25D::IPRC//PACK

:16S:STAT

:16S:GENL

:16R:CADETL

:13A::CAON//002

:22H::CAOP//OVER

:97A::SAFE// OCSD123400

:35B:ISIN GB0000SHARE1

SAMPLE SHARE:36B::STAQ//UNIT/100,

:16S:CADETL

2.4.6.7 PRIO VOLU – MT566 NEWM

:16R:GENL

:20C::CORP//PRIO00001401

:20C::SEME//CS10591190

:23G:NEWM

:22F::CAEV//PRIO

:98C::PREP//20190909105506

:16R:LINK

:13A::LINK//564

:20C::PREV//CS10566530

:16S:LINK

:16R:LINK

:13A::LINK//565

:20C::RELA//20190906scb01

:16S:LINK

:16S:GENL

:16R:USECU

:97A::SAFE//OCSD123400

:35B:ISIN GB00BYSRJ698

LONMIN PLC DL 0,0001

:93B::CONB//UNIT/1000,

:16S:USECU

:16R:CADETL

:98A::RDTE//20190904

:16S:CADETL

:16R:CACONF

:13A::CAON//002

:22F::CAOP//OVER

:16R:SECMOVE

:22H::CRDB//CRED

:35B:ISIN GB00B03MLX29
ROYAL DUTCH NAM EURO,07
:36B::PSTA//UNIT/100,
:22F::DISF//DIST
:92D::ADEX//1,/1,
:98A::POST//20190909
:98A::PAYD//20190906
:16S:SECMOVE
:16R:CASHMOVE
:22H::CRDB//DEBT
:97A::CASH//81000000000
:19B::PSTA//GBP28,
:19B::GRSS//GBP28,
:19B::NETT//GBP28,
:98A::POST//20190909
:98A::VALU//20190909
:98A::PAYD//20190906
:16S:CASHMOVE
:16S:CACONF

2.4.7 EXRI – Call on Intermediate Securities

2.4.7.1 EXRI CHOS - MT564 (NEWM)

:16R:GENL
:20C::CORP//EXRI00000102
:20C::SEME//CS19219100
:20C::COAF//ATEXRI00000102
:23G:NEWM

:22F::CAEV//EXRI
:22F::CAMV//CHOS
:98C::PREP//20200330140434
:25D::PROC//COMP
:16R:LINK
:13A::LINK//564
:20C::CORP//RHDI00029639
:16S:LINK
:16S:GENL
:16R:USECU
:35B:ISIN AT0000RIGHT1
SAMPLE RIGHT
:16R:ACCTINFO
:97A::SAFE// OCSD123400
:94F::SAFE//CUST/OCSDATWW
:93B::ELIG//UNIT/40,
:93B::SETT//UNIT/40,
:93B::UNBA//UNIT/40,
:16S:ACCTINFO
:16S:USECU
:16R:CADETL
:98C::GUPA//20200324140000
:98C::ECPD//20200324150000
:98C::ECRD//20200324160000
:16S:CADETL
:16R:CAOPTN

:13A::CAON//001
:22F::CAOP//EXER
:11A::OPTN//EUR
:17B::DFLT//N
:98C::MKDT//20200331180000
:98C::RDDT//20200331120000
:69A::PWAL//20200320/20200331
:36B::MIEX//UNIT/5,
:36B::MILT//UNIT/5,
:16R:SECMOVE
:22H::CRDB//CRED
:35B:ISIN AT0000SHARE1
SAMPLE SHARE
:22F::DISF//DIST
:92D::NEWO//4,/5,
:98A::PAYD//20200331
:16S:SECMOVE
:16R:SECMOVE
:22H::CRDB//DEBT
:35B:ISIN AT0000RIGHT1
SAMPLE RIGHT
:98B::PAYD//ONGO
:16S:SECMOVE
:16R:CASHMOVE
:22H::CRDB//DEBT
:98A::PAYD//20200331

:90B::PRPP//ACTU/EUR0,23

:16S:CASHMOVE

:16S:CAOPTN

:16R:CAOPTN

:13A::CAON//002

:22F::CAOP//SLLE

:11A::OPTN//EUR

:17B::DFLT//N

:98C::RDDT//20200330140000

:16R:SECMOVE

:22H::CRDB//DEBT

:35B:ISIN AT0000RIGHT1

SAMPLE RIGHTS

:69A::TRDP//20200326/20200330

:98B::PAYD//ONGO

:16S:SECMOVE

:16R:CASHMOVE

:22H::CRDB//CRED

:98B::PAYD//ONGO

:92A::CHAR//0,2

:90E::OFFR//UKWN

:16S:CASHMOVE

:16S:CAOPTN

:16R:CAOPTN

:13A::CAON//003

:22F::CAOP//BUYA

:11A::OPTN//EUR
:17B::DFLT//N
:98C::RDDT//20200330140000
:16R::SECMOVE
:22H::CRDB//CRED
:35B::ISIN AT0000RIGHT1
SAMPLE RIGHT
:69A::TRDP//20200326/20200330
:98B::PAYD//ONGO
:16S::SECMOVE
:16R::CASHMOVE
:22H::CRDB//DEBT
:98B::PAYD//ONGO
:92A::CHAR//0,2
:90E::PRPP//UKWN
:16S::CASHMOVE
:16S::CAOPTN
:16R::CAOPTN
:13A::CAON//004
:22F::CAOP//LAPS
:17B::DFLT//Y
:98C::MKDT//20200331180000
:98C::RDDT//20200331120000
:69A::PWAL//20200320/20200331
:16R::SECMOVE
:22H::CRDB//DEBT

:35B:ISIN AT0000RIGHT1

SAMPLE RIGHTS

:98A::PAYD//20200402

:16S:SECMOVE

:16S:CAOPTN

:16R:ADDINFO

:95R::PAYA/OCSD/ 123400

:16S:ADDINFO

2.4.7.2 EXRI CHOS - MT565 BUYA Instruction (NEWM)

:16R:GENL

:20C::CORP//EXRI00000102

:20C::SEME//20200330scb06

:20C::COAF//ATEXRI00000102

:23G:NEWM

:22F::CAEV//EXRI

:98C::PREP//20180625155304

:16S:GENL

:16R:USECU

:35B:ISIN AT0000RIGHT1

SAMPLE RIGHT

:16R:ACCTINFO

:97A::SAFE// OCSD123400

:16S:ACCTINFO

:16S:USECU

:16R:CAINST

:13A::CAON//003

:22F::CAOP//BUYA

:36B::QINS//UNIT/111,

:16S:CAINST

2.4.7.3 EXRI CHOS – MT567 INST (25D::IPRC//REJT)

:16R:GENL

:20C::CORP//EXRI00000102

:20C::SEME//CS19220040

:20C::COAF//ATEXRI00000102

:23G:INST

:22F::CAEV//EXRI

:98C::PREP//20200330141636

:16R:LINK

:13A::LINK//565

:20C::RELA//20200330scb06

:16S:LINK

:16R:STAT

:25D::IPRC//REJT

:16R:REAS

:24B::REJT//ADEA

:70D::REAS//Instruction received after Client

Deadline

:16S:REAS

:16R:REAS

:24B::REJT//SAFE

:70D::REAS//Unrecognised or invalid message

sender's safekeeping account

:16S:REAS

:16S:STAT

:16S:GENL

:16R:CADETL

:13A::CAON//003

:22H::CAOP//BUYA

:97A::SAFE// OCSD123400

:35B:ISIN AT0000RIGHT1

SAMPLE RIGHT

:36B::STAQ//UNIT/111,

:16S:CADETL

2.4.7.4 EXRI CHOS - MT565 EXER Instruction (NEWM)

:16R:GENL

:20C::CORP//EXRI00000102

:20C::SEME//20200330scb07

:20C::COAF//ATEXRI00000102

:23G:NEWM

:22F::CAEV//EXRI

:98C::PREP//20180625155304

:16S:GENL

:16R:USECU

:35B:ISIN AT0000RIGHT1

SAMPLE RIGHT

:16R:ACCTINFO

:97A::SAFE// OCSD123400

:16S:ACCTINFO

:16S:USECU

:16R:CAINST

:13A::CAON//001

:22F::CAOP//EXER

:36B::QINS//UNIT/100,

:16S:CAINST

2.4.8 EXRI CHOS – MT567 INST (25D::IPRC//PEND)

:16R:GENL

:20C::CORP//EXRI00000102

:20C::SEME//CS19220060

:20C::COAF//ATEXRI00000102

:23G:INST

:22F::CAEV//EXRI

:98C::PREP//20200330143136

:16R:LINK

:13A::LINK//565

:20C::RELA//20200330scb07

:16S:LINK

:16R:STAT

:25D::IPRC//PEND

:16S:STAT

:16S:GENL

:16R:CADETL

:13A::CAON//001

:22H::CAOP//EXER

:97A::SAFE// OCSD123400

:35B:ISIN AT0000RIGHT1

SAMPLE RIGHT:36B::STAQ//UNIT/100,

:16S:CADETL

2.4.8.1 EXRI CHOS – MT567 INST (25D::IPRC//PACK)

:16R:GENL

:20C::CORP//EXRI00000102

:20C::SEME//CS19220070

:20C::COAF//ATEXRI00000102

:23G:INST

:22F::CAEV//EXRI

:98C::PREP//20200330143435

:16R:LINK

:13A::LINK//565

:20C::RELA//20200330scb07

:16S:LINK

:16R:STAT

:25D::IPRC//PACK

:16S:STAT

:16S:GENL

:16R:CADETL

:13A::CAON//001

:22H::CAOP//EXER

:97A::SAFE// OCSD123400

:35B:ISIN AT0000RIGHT1

SAMPLE RIGHT 36B::STAQ//UNIT/100,

:16S:CADETL

2.4.8.2 EXRI CHOS - MT565 EXER Instruction (CANC)

:16R:GENL

:20C::CORP//EXRI00000102

:20C::SEME//20200330scb08

:20C::COAF//ATEXRI00000102

:23G:CANC

:22F::CAEV//EXRI

:16R:LINK

:13A::LINK//565

:20C::PREV//20200330scb07

:16S:LINK

:16S:GENL

:16R:USECU

:35B:ISIN AT0000RIGHT1

SAMPLE RIGHT

:16R:ACCTINFO

:97A::SAFE// OCSD123400

:16S:ACCTINFO

:16S:USECU

:16R:CAINST

:13A::CAON//001

:22F::CAOP//EXER

:36B::QINS//UNIT/100,

:16S:CAINST

2.4.8.3 EXRI CHOS - MT567 CAST (25D:CPRC//CANP)

:16R:GENL

:20C::CORP//EXRI00000102

:20C::SEME//CS19220080

:20C::COAF//ATEXRI00000102

:23G:CAST

:22F::CAEV//EXRI

:98C::PREP//20200330143636

:16R:LINK

:13A::LINK//565

:20C::RELA//20200330scb07

:16S:LINK

:16R:STAT

:25D::CPRC//CANP

:16S:STAT

:16S:GENL

:16R:CADETL

:13A::CAON//001

:22H::CAOP//EXER

:97A::SAFE// OCSD123400

:35B:ISIN AT0000RIGHT1

SAMPLE RIGHT:36B::STAQ//UNIT/100,

:16S:CADETL

2.4.8.4 EXRI CHOS - MT567 CAST (25D:CPRC//PACK)

:16R:GENL

:20C::CORP//EXRI00000102

:20C::SEME//CS19220100

:20C::COAF//ATEXRI00000102

:23G:CAST
:22F::CAEV//EXRI
:98C::PREP//20200330144836
:16R:LINK
:13A::LINK//565
:20C::RELA//20200330scb07
:16S:LINK
:16R:STAT
:25D::CPRC//PACK
:16R:REAS
:24B::CAND//CANI
:16S:REAS
:16S:STAT
:16S:GENL
:16R:CADETL
:13A::CAON//001
:22H::CAOP//EXER
:97A::SAFE// OCSD123400
:35B:ISIN AT0000RIGHT1
SAMPLE RIGHT
:36B::STAQ//UNIT/100,
:16S:CADETL

2.5 Corporate Action Instruction Process Management

This chapter describes the instruction processing flow for the message types MT565 and MT567 including the rejection reasons.

2.5.1 Corporate Action Instruction MT565 (NEWM)

This message is used to provide the custodian or agent with instructions on how the securities account holder would like to proceed with a corporate action event. Instructions include investment decisions regarding the exercise of rights issues, the election of stock or cash when the option is available and decisions on the conversion or tendering of securities.

An Instruction to a given corporate action event should be addressed to **production-CUG BIC (OCSDATW2XXX)** of OeKB CSD and has to contain at least the following:

Receiver BIC: **OCSDATW2XXX**

:20C::CORP//TEND00004901 => Related Corporate Action Event

:97A::SAFE//OCSD123400 => Prefix "OCSD" incl. "**6 digit** Securities Account Number"

Example:

:16R:GENL

:20C::CORP//TEND00000401

:20C::SEME//20200323scb02

:20C::COAF//ATTEND00000401

:23G:NEWM

:22F::CAEV//TEND

:16S:GENL

:16R:USECU

:35B:ISIN AT000000STR1

STRABAG AKT O.N.

:16R:ACCTINFO

:97A::SAFE// OCSD123400

:16S:ACCTINFO

:16S:USECU

:16R:CAINST

:13A::CAON//001

:22F::CAOP//SECU

:36B::QINS//UNIT/2222,

:16S:CAINST

2.5.2 Corporate Action Instruction MT565 (CANC)

In order to cancel a previously sent message, you have to use the function CANC. The reference in the linkages sequence must contain the sender's reference of the message to be cancelled. A copy of at least the mandatory fields of the message to be cancelled must be present; optional fields do not need to be present for SWIFT validation.

:16R:GENL

:20C::CORP//TEND00000401

:20C::SEME//20200323scb03

:20C::COAF//ATTEND00000401

:23G:CANC

:22F::CAEV//TEND

:16R:LINK

:13A::LINK//565

:20C::PREV//20200323scb02

:16S:LINK

:16S:GENL

:16R:USECU

:35B:ISIN AT000000STR1

STRABAG AKT O.N.

:16R:ACCTINFO

:97A::SAFE//OCSD123400

:16S:ACCTINFO

:16S:USECU

:16R:CAINST

:13A::CAON//001

:22F::CAOP//SECU

:36B::QINS//UNIT/2222,

:16S:CAINST

2.5.3 Instruction Processing Flow (SWIFT ISO 15022)

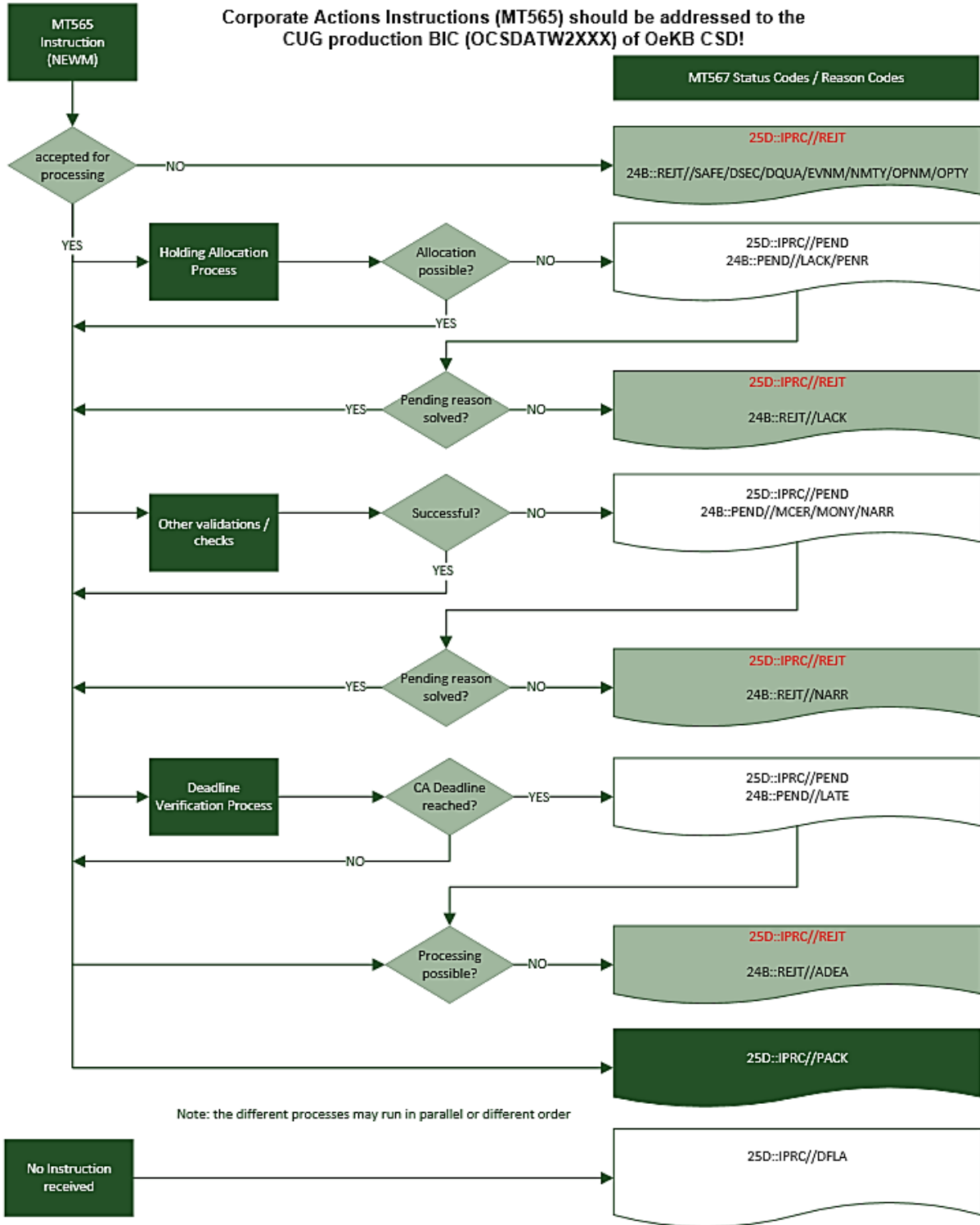

mandatory fields for MT565 NEWM:

:20C::CORP//TEND00004901 => Related Corporate Action Event

:97A::SAFE//OCSD123400 => Prefix "OCSD" incl. 6 digit Securities Account Number

The received MT565 will first run through various validation steps which might lead to a rejection. Following rejection reasons codes are provided within the sent MT567 25D::IPRC//REJT:

Reason code	Reason in the MT567	Processing Status	Description
DSEC	Unrecognized or Invalid Tradable Asset.	AutoRejected	Creation of an instruction with an unrecognized or invalid tradable asset
EVNM	Unrecognized CA Event Number.	AutoRejected	Received MT565 with wrong CA number
NMTY	Mismatch with The Entitled Security.	AutoRejected	Received MT565 with wrong Entitled Security
NMTY	Mismatch between OptionNumber and OptionType.	AutoRejected	Received MT565 with mismatch between Option number and Option type
OPTY	Invalid Option Type.	AutoRejected	Received MT565 with wrong option type
SAFE	Invalid sender for the account number/Unrecognised or invalid message sender's safekeeping account.	AutoRejected	Received MT565 with invalid sender for the account number
NARR	Pending Validation of Instruction on blocked account	Pending	Instruction on a blocked account
NARR	Narrative Verification Pending	Pending	If the instruction comment is different from null and the option has "Narrative processed" is equal to false
ADEA	Instruction received after Client Deadline.	Pending/Rejected	Instruction received or created after Client Deadline
DQUA	Invalid Instructed Quantity.	Pending/Rejected	Instructed quantity with wrong quantity
LATE	Instruction received after Market Deadline.	Pending/Rejected	Instruction received or created after Market Deadline

Reason code	Reason in the MT567	Processing Status	Description
NARR	Invalid Conditional Quantity.	Pending/Rejected	Instructed quantity does not respect the conditional quantity initially fixed
NARR	Invalid Instructed Price.	Pending/Rejected	If the option of the concerned instruction has offered price = "Price to be specified" and the instructed price is equal to zero
NARR	Instructed quantity is not a multiple of the parity out.	Pending/Rejected	If the instructed quantity does not respect the relation of parity
NARR	Invalid Quantity Type.	Pending/Rejected	Instructed quantity with wrong type
LACK	Not Enough Position.	Rejected	Not enough position for the concerned client
NARR	Instruction on blocked account not allowed.	Rejected	Instruction on a blocked account
NARR	Option does not support offered price or Option requires an offered price.	Rejected	Instruction price does not respect the conditional price
NARR	Narrative Validation Failed	Rejected	If the instruction comment is different from null and the option has "Narrative processed" is equal to false
NARR	No narrative received on behalf of an option	Rejected	If the instruction comment = null and the option disclosure needed is equal to true.

2.5.4 Instruction Cancellation Processing Flow (SWIFT ISO 15022)

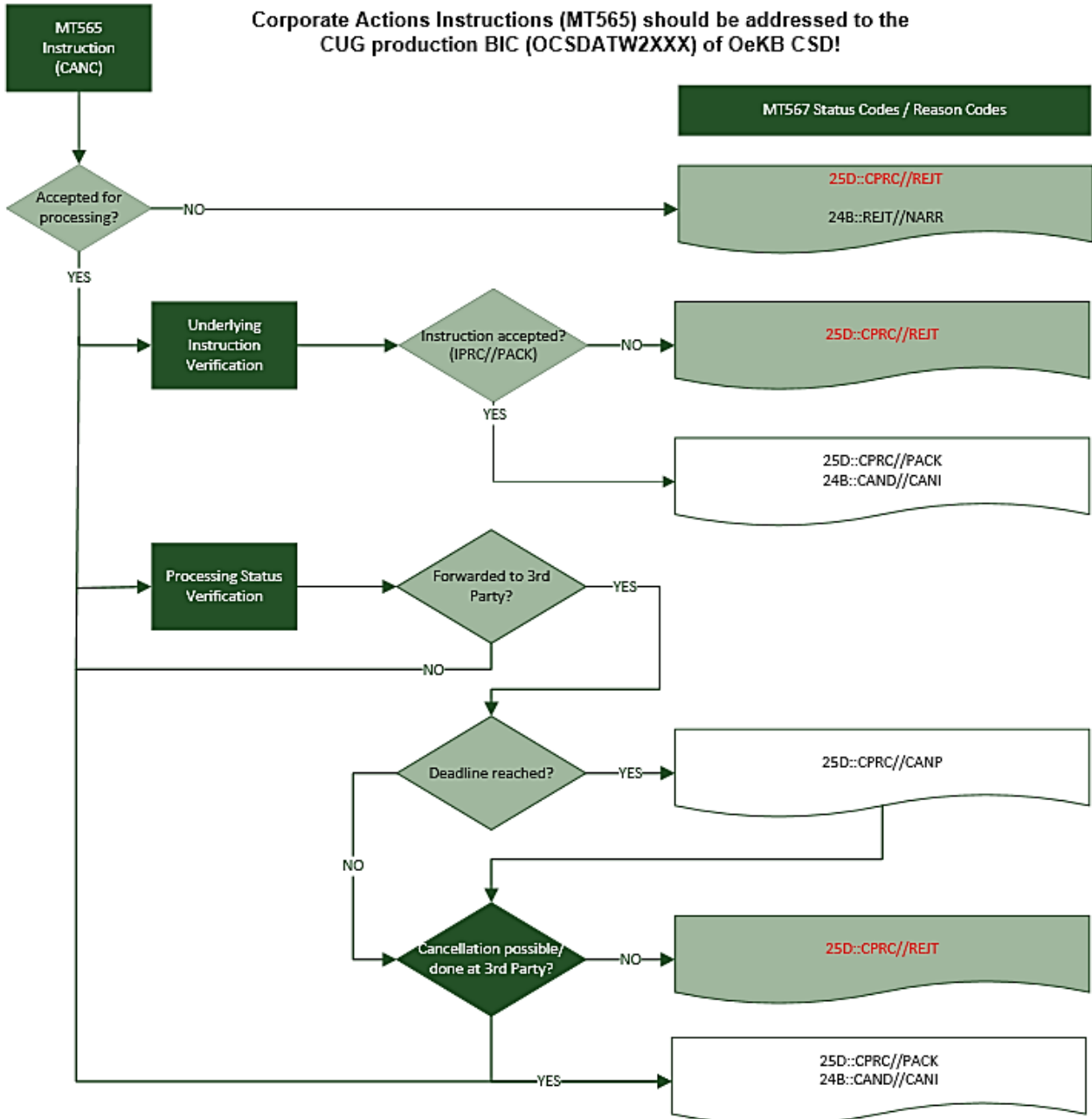

- Note:
- Positiv status/reason codes are shown in white
 - additional rejection reasons as listed below
 - main transmission status of a MT567:

25D::CPRC//CAMP	Pending Cancellation
25D::CPRC//PACK	Accepted Cancellation
25D::CPRC//REJT	Rejected Cancellation

As soon as a MT565 CANC is received, first validation checks will be performed and a MT567 is sent to the client with message function: 23G::CAST

Status Code	Description	Reason Code
25D::CPRC//CANP	Pending Cancellation will be sent to the client to inform him that the request for instruction cancellation was received and being verified	
25D::CPRC//PACK	Accepted Cancellation will be sent to the client to inform him that the instruction was cancelled	CANI
25D::CPRC//REJT	Rejected Cancellation will be sent to the client if the request for cancellation wasn't accepted	See list below

25D::CPRC//REJT with following reason codes:

Reason code	Reason in the MT567	Processing Status	Description
DSEC	Unrecognized or Invalid Tradable Asset.	AutoRejected	Cancellation of an instruction with an unrecognized or invalid Tradable asset
EVNM	Unrecognized CA Event Number.	AutoRejected	Received MT 565 CANC with wrong CA number
NARR	Incorrect PREV reference	AutoRejected	Received MT565 CANC with incorrect PREV reference
NMTY	Mismatch with The Entitled Security.	AutoRejected	Received MT 565 CANC with wrong Entitled Security
NMTY	Mismatch between OptionNumber and OptionType.	AutoRejected	Received MT 565 CANC with mismatch between Option number and Option type
OPTY	Invalid Option Type.	AutoRejected	Received MT 565 CANC with wrong option type
SAFE	Invalid sender for the account number/Unrecognised or invalid message sender's safekeeping account.	AutoRejected	Received MT 565 CANC with invalid sender for the account number

3. SWIFT Manual for Issuers ISO 15022

3.1 Issuer Information also via SWIFT ISO 15022

Issuers are required to submit information according to Annex 9 Information required for the Safekeeping and Administration of the Securities Categories.

If an issuer intends to send messages in SWIFT ISO 15022 the following mandatory key field should be included in the message:

:97A: :SAFE//Dummy account No

Option A	:4!c//35x	(Qualifier)(Account Number)
Option C	:4!c//4!c	(Qualifier)(Account Code)

3.2 Change volume via SWIFT

3.2.1 MT540 - Receive Free of Payment (Increase)

MT540 is used for the receipt of securities free of payment (RFP).

Content

M/O	Tag	Field Name	Qualifier	Option	Format	Codes	Description
<i>Mandatory Sequence A General Information</i>							
M	:16R:	Start of Block			16c	GENL	
M	:20C:	Sender's Reference	SEME		:4!c//16x		Reference assigned by the sender to unambiguously identify the message
M	:23G:	Function of the Message			4!c	PREA	Message preadvicing a settlement instruction.
						NEWM	New message

M/O	Tag	Field Name	Qualifier	Option	Format	Codes	Description
						CANC	Message requesting the cancellation of a previously sent message.
O	:99B:	Number Count	SETT		:4!c//3!n	000-999	Sequential number of the instruction in a range of linked settlement instructions.
O	:99B:	Number Count	TOSE		:4!c//3!n	000-999	Total number of settlement instructions that are linked together.

Optional Repetitive Subsequence A1 Linkages

M	:16R:	Start of Block			16c	LINK	
O	:22F:	Linkage Type Indicator	LINK		:4!c/[8c]/4!c	AFTE	Indicates that the message is to be processed after the linked message.
						BEFO	Indicates that the message is to be processed before the linked message.
						WITH	Indicates that the message is to be processed with the linked message.
						INFO	Indicates that the messages are linked for information purposes only.
O	:13A:	Linked Transaction	LINK		:4!c//3!c		Message type number/message identifier of the message referenced in the linkage sequence.
M	:20C:	Reference	RELA		:4!c//16x		Related Message Reference

M/O	Tag	Field Name	Qualifier	Option	Format	Codes	Description
			PREV				Previous Message Reference
			PREA				Preadvice Message Reference
			POOL				Pool Reference
			COMM				Common Reference
			PCTI				Processor Transaction Identification
M	:16S:	End of Block			16c	LINK	
<i>End of Subsequence A1 Linkages</i>							
M	:16S:	End of Block			16c	GENL	
<i>End of Sequence A General Information</i>							
<i>Mandatory Sequence B Trade Details</i>							
M	:16R:	Start of Block			16c	TRADEDET	
O	:94H:	Place of Clearing	CLEA		:4!c//4!a2!a2!c[3!c]		
O	:94B:	Place of Trade	TRAD		:4!c//4!c[/30x]	EXCH	Place of trade is a stock exchange
						OTCO	Place of trade is over the counter.
						PRIM	Place of trade is the primary market.
						SECM	Place of trade is the secondary market.
						VARI	Trade was executed on various places.
M	:98a:	Trade Date/Time	TRAD	A	:4!c//8!n		Date at which the trade was executed.
				C	:4!c//8!n6!n		Date and time at which the trade was executed.

M/O	Tag	Field Name	Qualifier	Option	Format	Codes	Description
M	:98A:	Settlement Date	SETT		:4!c//8!n		Date at which the financial instruments are to be delivered or received.
M	:35B:	Identification of the Financial Instrument			ISIN1!e12!c 4*35x		"ISIN" followed by <Blank> and ISIN Code Description of the financial instrument (optional)
O	:22F:	Priority Indicator	PRIR		:4!c//4!c	0003 0004	High priority Normal priority
O	:22F:	Trade Transaction Condition Indicator	TTCO		:4!c/[8c]/4!c	CCPN XCPN	Trade was executed cum coupon. Trade was executed ex coupon.
O	:25D:	Status	MTCH		:4!c/[8c]/4!c	MACH	Instruction has been matched.
O	:70E:	Narrative	SPRO		:4!c//10*35x		Provides additional settlement processing information which cannot be included within the structured fields of the message.
M	:16S:	End of Block			16c	TRADEDET	
<i>End of Sequence B Trade Details</i>							
<i>Mandatory Sequence C Financial Instrument/Account</i>							
M	:16R:	Start of Block			16c	FIAC	
M	:36B:	Quantity of Financial Instrument to be Settled	SETT		:4!c//4!c/15d	FAMT UNIT	Face amount Unit number

M/O	Tag	Field Name	Qualifier	Option	Format	Codes	Description
M	:97A:	Safekeeping Account	SAFE		:4!c//35x		OeKB CSD's securities account number of the customer
M	:16S:	End of Block			16c	FIAC	
<i>End of Sequence C Financial Instrument/Account</i>							
<i>Mandatory Sequence E Settlement Details</i>							
M	:16R:	Start of Block			16c	SETDET	
M	:22F:	Type of Settlement Transaction	SETR		:4!c/[8!c]/4!c	TRAD	Specifies underlying information regarding the type of settlement transaction
						MKUP	Relates to the increase of positions.
					:4!c/COEX/4!c	AUTO	Auto-collateralisation, in case of an Intra-day Restriction on the eligible ISIN
O	:22F:	Settlement Transaction Condition Indicator	STCO		:4!c/[8!c]/4!c	NPAR	Partial settlement is not allowed.
						PART	Partial settlement is allowed. Not allowed for MKUP/MKDW
						NOMC	No market claim should be automatically generated. Not allowed for MKUP/MKDW
					:4!c/COEX/4!c	PARQ	Partial Settlement is Allowed with Minimum Quantity Not allowed for MKUP/MKDW

M/O	Tag	Field Name	Qualifier	Option	Format	Codes	Description
						PARC	Partial Settlement is Allowed with Minimum Cash Value Not allowed for MKUP/MKDW
					:4!c/REGL/4!c	BSSP	Instruction Resulting from Partially Successful Buy-In
O	:22F:	Securities Sub-balance Type Indicator	SSBT		:4!c/[8c]/4!c	EEUR	Earmarking for autocoll.
						EARn	Other earmarking
O	:22F:	Beneficial Ownership Indicator	BENE		:4!c/[8c]/4!c	NBEN	No Change of Beneficial Ownership (NCBO)
						YBEN	Change of Beneficial Ownership (CBO)
<i>Mandatory Repetitive Subsequence E1 Settlement Parties</i>							
M	:16R:	Start of Block			16c	SETPRTY	
M	:95P:	Place of Settlement	PSET		:4!c//4!a2!a2!c[3!c]		Place of settlement (depository)
M	:16S:	End of Block			16c	SETPRTY	
M	:16R:	Start of Block			16c	SETPRTY	
M	:95P:	Delivering Agent	DEAG		:4!c//4!a2!a2!c[3!c]		Delivering party that interacts with the place of settlement.
(M)	:97A:	Safekeeping Account	SAFE		4!c//35x		Counterparty's securities acc. number
M	:16S:	End of Block			16c	SETPRTY	
O	:16R:	Start of Block			16c	SETPRTY	
O	:95a:	Deliverer's Intermediary 2	DEI2	P	:4!c//4!a2!a2!c[3!c]		Party that interacts with
				R	:4!c/8!c/34x		

M/O	Tag	Field Name	Qualifier	Option	Format	Codes	Description
				Q	:4!c//4*35x		the deliverer's intermediary 1
O	:97A:	Safekeeping Account	SAFE		:4!c//35x		No. of securities acc. held with the party one step higher in the chain
O	:16S:	End of Block			16c	SETPRTY	
O	:16R:	Start of Block			16c	SETPRTY	
O	:95a:	Deliverer's Intermediary 1	DEI1	P	:4!c//4!a2!a2!c[3!c]		Party that interacts with the delivering agent.
				R	:4!c/8!c/34x		
				Q	:4!c//4*35x		
O	:97A:	Safekeeping Account	SAFE		:4!c//35x		No. of securities acc. held with the party one step higher in the chain
O	:16S:	End of Block			16c	SETPRTY	
O	:16R:	Start of Block			16c	SETPRTY	
O	:95a:	Receiver's Custodian	DECU	P	:4!c//4!a2!a2!c[3!c]		Party that interacts with the delivering agent unless intermediaries exist
				R	:4!c/8!c/34x		
				Q	:4!c//4*35x		
O	:97A:	Safekeeping Account	SAFE		:4!c//35x		No. of securities acc. held with the party one step higher in the chain
O	:16S:	End of Block			16c	SETPRTY	
O	:16R:	Start of Block			16c	SETPRTY	
O	:95a:	Seller	SELL	P	:4!c//4!a2!a2!c[3!c]		Party that delivers the financial instrument
				R	:4!c/8!c/34x		
				Q	:4!c//4*35x		
O	:97A:	Safekeeping Account	SAFE		:4!c//35x		No. of securities acc. held with the party one step higher in the chain
O	:16S:	End of Block			16c	SETPRTY	

M/O	Tag	Field Name	Qualifier	Option	Format	Codes	Description
O	:16R:	Start of Block			16c	SETPRTY	
O	:95P:	Receiving Agent	REAG		:4!c//4!a2!a2!c[3!c]		Receiving party that interacts with the place of settlement.
O	:16S:	End of Block			16c	SETPRTY	
O	:16R:	Start of Block			16c	SETPRTY	
O	:95a:	Receiver's Intermediary 2	REI2	P	:4!c//4!a2!a2!c[3!c]		Party that interacts with the receiver's intermediary 1
				R	:4!c/8!c/34x		
				Q	:4!c//4*35x		
O	:97A:	Safekeeping Account	SAFE		:4!c//35x		No. of safekeeping acc. held with the party one step higher in the chain
O	:16S:	End of Block			16c	SETPRTY	
O	:16R:	Start of Block			16c	SETPRTY	
O	:95a:	Receiver's Intermediary 1	REI1	P	:4!c//4!a2!a2!c[3!c]		Party that interacts with the receiving agent
				R	:4!c/8!c/34x		
				Q	:4!c//4*35x		
O	:97A:	Safekeeping Account	SAFE		:4!c//35x		No. of securities acc. held with the party one step higher in the chain
O	:16S:	End of Block			16c	SETPRTY	
O	:16R:	Start of Block			16c	SETPRTY	
O	:95a:	Receiver's Custodian	RECU	P	:4!c//4!a2!a2!c[3!c]		Party that interacts with the receiving agent unless intermediaries exist
				R	:4!c/8!c/34x		
				Q	:4!c//4*35x		
O	:97A:	Safekeeping Account	SAFE		:4!c//35x		No. of securities acc. held with the party one step higher in the chain
O	:16S:	End of Block			16c	SETPRTY	
O	:16R:	Start of Block			16c	SETPRTY	

M/O	Tag	Field Name	Qualifier	Option	Format	Codes	Description
O	:95a:	Buyer	BUYR	P	:4!c//4!a2!a2!c[3!c]		Party that receives the financial instrument
				R	:4!c/8!c/34x		
				Q	:4!c//4*35x		
O	:97A:	Safekeeping Account	SAFE		:4!c//35x		No. of securities acc. held with the party one step higher in the chain
M	:16S:	End of Block			16c	SETPRTY	
<i>End of Subsequence E1 Settlement Parties</i>							
M	:16S:	End of Block			16c	SETDET	
<i>End of Sequence E Settlement Details</i>							

3.2.1.1 Explanation of the SWIFT Fields

Sequence A - General Information

— :23G: - Function of the Message

The PREA/NEWM function will be replaced with Hold/Release in T2S. The PREA/NEWM function will remain available for submitting instructions in ISO 15022 format.

PREA: New instruction with On Hold = yes; The position is not released for settlement.

NEWM: New instruction with On Hold = no; The position is released for settlement. After a NEWM was submitted an MT530 or the Settlement Client must be used to change the On Hold setting.

CANC: Cancellation of the instruction.

— :99B: - Number Count

Instructions with a pool reference must include a pool counter indicating the total number of linked instructions.

SETT: Mandatory if the pool reference in the Optional Repetitive Subsequence A1 Linkages is filled.

TOSE: Mandatory if the pool reference in the Optional Repetitive Subsequence A1 Linkages is filled.

External-CSD Settlement: Linking of instructions is not possible.

— :22F: - Linkage Type Indicator

AFTE: Current instruction will be settled AFTER the linked-to instruction.

BEFO: Current instruction will be settled BEFORE the linked-to instruction.

WITH: Current instruction will be settled together WITH the linked-to instruction.

INFO: The LINK is added for informational purposes only and has no effects on the processing.

External-CSD Settlement: Linking of instructions is not possible.

Optional Repetitive Subsequence A1 Linkages

— :20C: - Reference

RELA: Customer reference of the referenced instruction (if A1:22F:LINK exists in this subsequence).

PREV: Customer reference of the instruction to be cancelled (in case of A:23G:CANC).

PREA: Customer reference of the instruction with PREA function (in case of A:23G:NEWM).

POOL: A pool reference can be used to link more than two instructions. It is a collective reference for a set of settlement instructions which must be settled collectively "*all-or-none*".

COMM: Unique reference agreed between two counterparties to identify the instruction.

PCTI: In case of cancellation orders for instructions where the instructing party is different from the instructing party of the instruction being cancelled, this field has to contain the PCTI reference from the MT 548 status message.

- Instructions, which have been created by the OeKB CSD as instructing party (e.g. market claim or transformation)
- Instructions, which have been created by an authorised party but which are cancelled by the securities account owner

In addition the field :20C::PREV must be filled in with NONREF, because according to ISO 15022 SWIFT standard field :20C::PREV must be present, if field :23G: is CANC.

Mandatory Sequence B Trade Details

— :98A: - Date

SETT: It is no longer possible to specify the exact time on the settlement day.

— :22F: - Priority Indicator

PRIR: When prioritising instructions it is possible to choose from 2 priority levels: High Priority (0003) and Normal Priority (0004). For details, please see *Annex 8 Guideline Settlement and Securities Account Administration*.

External-CSD Settlement: Prioritising of instructions is not possible.

— :22F: - Trade Transaction Condition Indicator

TTCO: This qualifier specifies whether the security is delivered with (CCPN – Cum Coupon) or without (XCPN – Ex Coupon) coupon (additional matching field).

External-CSD Settlement: This indicator is not used.

Mandatory Sequence C Financial Instrument/Account

— :97A: Safekeeping Account

The securities account number can be specified in the old format (e.g. 123400) or in the new format "OCSD + existing securities account number" (e.g. OCSD123400).

Mandatory Sequence E Settlement Details

— :22F: -Settlement Transaction Condition Indicator

NPAR: Partial settlement of an instruction is not allowed.

PART: Partial settlement of an instruction is allowed.

PARQ: Partial Settlement is allowed with Minimum Quantity

PARC: Partial Settlement is allowed with Minimum Cash Value

NOMC: Opt-out indicator (additional matching field).

BSSP: Instruction Resulting from Partially Successful Buy-In. If the matching instruction is also instructed with this Settlement Transaction Condition both instructions will be exempt from Late Matching penalty fees. It is not a matching field.

For details, please see *Annex 8 Guideline Settlement and Securities Account Administration*.

External-CSD Settlement: Partial settlement is not possible.

— :22F: - Securities Sub-balance Type Indicator

SSBT: For this qualifier the use of Data Source Scheme "RT" (:4!c/RT/4!c) is compulsory.

For the code EARn the rule "1<=n<=9", e.g. EAR1, EAR2,....., EAR9 applies.

Mandatory Repetitive Subsequence E1 Settlement Parties

— :95P: - Place of Settlement

PSET: For identification the BIC of the counterparty's CSD (depository) is used as the sole reference.

— :95P: - Delivering Agent

This field is used to identify the counterparty using the BIC.

— :97A: - Safekeeping Account

This field is optional. It is not considered for intra-CSD and cross-CSD settlement.

For transaction type external-CSD settlement this field must contain the securities account number as at present.

— :95a: - Receiver's Intermediary 2/Receiver's Intermediary 1/Receiving Custodian/ Buyer

It is possible to send all 5 parties (incl. DEAG). Please note, however, that except in the case of DEAG the following sequence must be observed for the parties: DEAG, DEI2, DEI1, DECU, SELL.

It is possible to shorten the chain, e.g. only SELL or only DEI1, DECU, SELL but the sequence must be observed in all cases.

— :95a: - Deliverer's Intermediary 2/Deliverer's Intermediary 1/Deliverer's Custodian/ Seller

Aside from the optional REAG, 4 additional parties can be specified on the deliverer side. For these 4 additional parties the following sequence must be observed: REI2, REI1, RECU, BUYR.

It is possible to shorten the chain, e.g. only BUYR or only REI1, RECU, BUYR but the sequence must be observed in all cases.

3.2.1.2 MT540 Example for Increase

Transaction Type Increase

:16R:GENL
:20C::SEME//HUA0710incrm01
:23G:NEWM
:16S:GENL
:16R:TRADEDET
:98A::TRAD//20161007
:98A::SETT//20161007
:35B:ISIN AT0000A0ENT5
:16S:TRADEDET
:16R:FIAC
:36B::SETT//FAMT/10000,
:97A::SAFE//OCSD236500
:16S:FIAC
:16R:SETDET
:22F::SETR//MKUP
:16R:SETPRTY
:95P::PSET//OCSDATWWXXX
:16S:SETPRTY
:16R:SETPRTY
:95P::DEAG//OCSDATWWXXX
:16S:SETPRTY
:16S:SETDET

3.2.2 MT542 – Deliver Free of Payment (Decrease)

MT542 is used for the delivery of securities free of payment (DFP).

Content

M/O	Tag	Field Name	Qualifier	Option	Format	Codes	Description
<i>Mandatory Sequence A General Information</i>							
M	:16R:	Start of Block			16c	GENL	
M	:20C:	Sender's Reference	SEME		:4!c//16x		Reference assigned by the sender to unambiguously identify the message
M	:23G:	Function of the Message			4!c	PREA NEWM CANC	Message preadvising a settlement instruction. New message Message requesting the cancellation of a previously sent message.
O	:99B:	Number Count	SETT		:4!c//3!n	000-999	Sequential number of the instruction in a range of linked settlement instructions.
O	:99B:	Number Count	TOSE		:4!c//3!n	000-999	Total number of settlement instructions that are linked together.
<i>Optional Repetitive Subsequence A1 Linkages</i>							
M	:16R:	Start of Block			16c	LINK	
O	:22F:	Linkage Type Indicator	LINK		:4!c/[8c]/4!c	AFTE BEFO WITH INFO	Indicates that the message is to be processed after the linked message. Indicates that the message is to be processed before the linked message. Indicates that the message is to be processed with the linked message. Indicates that the messages are linked for information purposes only.
O	:13A:	Linked Transaction	LINK		:4!c//3!c		Message type number/message identifier of the message referenced in the linkage sequence.
M	:20C:	Reference	RELA		:4!c//16x		Related Message Reference

M/O	Tag	Field Name	Qualifier	Option	Format	Codes	Description
			PREV				Previous Message Reference
			PREA				Preadvice Message Reference
			POOL				Pool Reference
			COMM				Common Reference
			PCTI				Processor Transaction Identification
M	:16S:	End of Block			16c	LINK	
<i>End of Subsequence A1 Linkages</i>							
M	:16S:	End of Block			16c	GENL	
<i>End of Sequence A General Information</i>							
<i>Mandatory Sequence B Trade Details</i>							
M	:16R:	Start of Block			16c	TRADDET	
O	:94H:	Place of Clearing	CLEA		:4!c//4!a2!a2!c[3!c]		
O	:94B:	Place of Trade	TRAD		:4!c//4!c[/30x]	EXCH OTCO PRIM SECM VARI	Place of trade is a stock exchange Place of trade is over the counter. Place of trade is the primary market. Place of trade is the secondary market. Trade was executed on various places.
M	:98a:	Trade Date/Time	TRAD	A	:4!c//8!n		Date at which the trade was executed.
				C	:4!c//8!n6!n		Date and time at which the trade was executed.
M	:98A:	Settlement Date	SETT		:4!c//8!n		Date at which the financial instruments are to be delivered or received.
M	:35B:	Identification of the Financial Instrument			ISIN1!e12!c 4*35x		"ISIN" followed by <Blank> and ISIN Code Description of the financial instrument (optional)
O	:22F:	Priority Indicator	PRIR		:4!c//4!c	0003 0004	High priority Normal priority
O	:22F:	Trade Transaction Condition Indicator	TTCO		:4!c/[8c]/4!c	CCPN XCPN	Trade was executed cum coupon. Trade was executed ex coupon.
O	:25D:	Status	MTCH		:4!c/[8c]/4!c	MACH	Instruction has been matched.

M/O	Tag	Field Name	Qualifier	Option	Format	Codes	Description
O	:70E:	Narrative	SPRO		:4!c//10*35x		Provides additional settlement processing information which cannot be included within the structured fields of the message.
M	:16S:	End of Block			16c	TRADEDET	
<i>End of Sequence B Trade Details</i>							
<i>Mandatory Sequence C Financial Instrument/Account</i>							
M	:16R:	Start of Block			16c	FIAC	
M	:36B:	Quantity of Financial Instrument to be Settled	SETT		:4!c//4!c/15d	FAMT UNIT	Face amount Unit number
M	:97A:	Safekeeping Account	SAFE		:4!c//35x		OeKB CSD's securities account number of the customer
<i>Optional Repetitive Subsequence C1 Quantity Breakdown</i>							
M	:16R:	Start of Block			16c	BREAK	
M	:13B:	Lot Number	LOTS		:4!c/[8c]/30x		Number identifying a lot constituting the financial instrument.
M	:16S:	End of Block				BREAK	
<i>End of Subsequence C1 Quantity Breakdown</i>							
M	:16S:	End of Block			16c	FIAC	
<i>End of Sequence C Financial Instrument/Account</i>							
<i>Mandatory Sequence E Settlement Details</i>							
M	:16R:	Start of Block			16c	SETDET	
M	:22F:	Type of Settlement Transaction	SETR		:4!c/[8!c]/4!c	TRAD MKDW	Specifies underlying information regarding the type of settlement transaction Relates to the decrease of positions.
					:4!c/COEX/4!c	AUTO	Auto-collateralisation, in case of an Intra-day Restriction on the eligible ISIN
O	:22F:	Settlement Transaction Condition Indicator	STCO		:4!c/[8c]/4!c	NPAR PART	Partial settlement is not allowed. Partial settlement is allowed. Not allowed for MKUP/MKDW

M/O	Tag	Field Name	Qualifier	Option	Format	Codes	Description
						NOMC	No market claim should be automatically generated. Not allowed for MKUP/MKDW
					:4!c/COEX/4!c	PARQ	Partial Settlement is Allowed with Minimum Quantity Not allowed for MKUP/MKDW
						PARC	Partial Settlement is Allowed with Minimum Cash Value Not allowed for MKUP/MKDW
					:4!c/REGL/4!c	BSSP	Instruction Resulting from Partially Successful Buy-In
O	:22F:	Securities Sub-balance Type Indicator	SSBT		:4!c/[8c]/4!c	BLO n	Blocking
						RES n	Reservation
						EEUR	Earmarking for autocoll.
						EAR n	Other earmarking
O	:22F:	Beneficial Ownership Indicator	BENE		:4!c/[8c]/4!c	NBEN	No Change of Beneficial Ownership (NCBO)
						YBEN	Change of Beneficial Ownership (CBO)
<i>Mandatory Repetitive Subsequence E1 Settlement Parties</i>							
M	:16R:	Start of Block			16c	SETPRTY	
M	:95P:	Place of Settlement	PSET		:4!c//4!a2!a2!c[3!c]		Place of settlement (depository)
M	:16S:	End of Block			16c	SETPRTY	
M	:16R:	Start of Block			16c	SETPRTY	
M	:95P:	Receiving Agent	REAG		:4!c//4!a2!a2!c[3!c]		Receiving party that interacts with the place of settlement
(M)	:97A:	Safekeeping Account	SAFE		4!c//35x		Counterparty's securities acc. number
M	:16S:	End of Block			16c	SETPRTY	
O	:16R:	Start of Block			16c	SETPRTY	
O	:95a:	Receiver's Intermediary 2	REI2	P	:4!c//4!a2!a2!c[3!c]		Party that interacts with the receiver's intermediary 1
				R	:4!c/8!c/34x		
				Q	:4!c//4*35x		

M/O	Tag	Field Name	Qualifier	Option	Format	Codes	Description
O	:97A:	Safekeeping Account	SAFE		:4!c//35x		No. of securities acc. held with the party one step higher in the chain
O	:16S:	End of Block			16c	SETPRTY	
O	:16R:	Start of Block			16c	SETPRTY	
O	:95a:	Receiver's Intermediary 1	REI1	P R Q	:4!c//4!a2!a2!c[3!c] :4!c/8!c/34x :4!c//4*35x		Party that interacts with the receiving agent
O	:97A:	Safekeeping Account	SAFE		:4!c//35x		No. of securities acc. held with the party one step higher in the chain
O	:16S:	End of Block			16c	SETPRTY	
O	:16R:	Start of Block			16c	SETPRTY	
O	:95a:	Receiver's Custodian	RECU	P R Q	:4!c//4!a2!a2!c[3!c] :4!c/8!c/34x :4!c//4*35x		Party that interacts with the receiving agent unless intermediaries exist
O	:97A:	Safekeeping Account	SAFE		:4!c//35x		No. of securities acc. held with the party one step higher in the chain
O	:16S:	End of Block			16c	SETPRTY	
O	:16R:	Start of Block			16c	SETPRTY	
O	:95a:	Buyer	BUYR	P R Q	:4!c//4!a2!a2!c[3!c] :4!c/8!c/34x :4!c//4*35x		Party that receives the financial instrument
O	:97A:	Safekeeping Account	SAFE		:4!c//35x		No. of securities acc. held with the party one step higher in the chain
O	:16S:	End of Block			16c	SETPRTY	
O	:16R:	Start of Block			16c	SETPRTY	
O	:95P:	Delivering Agent	DEAG		:4!c//4!a2!a2!c[3!c]	SETPRTY	Delivering party that interacts with the place of settlement.
O	:16S:	End of Block			16c	SETPRTY	
O	:16R:	Start of Block			16c	SETPRTY	
O	:95a:	Deliverer's Intermediary 2	DEI2	P R Q	:4!c//4!a2!a2!c[3!c] :4!c/8!c/34x :4!c//4*35x		Party that interacts with the deliverer's intermediary 1

M/O	Tag	Field Name	Qualifier	Option	Format	Codes	Description
O	:97A:	Safekeeping Account	SAFE		:4!c//35x		No. of securities acc. held with the party one step higher in the chain
O	:16S:	End of Block			16c	SETPRTY	
O	:16R:	Start of Block			16c	SETPRTY	
O	:95a:	Deliverer's Intermediary 1	DEI1	P R Q	:4!c//4!a2!a2!c[3!c] :4!c/8!c/34x :4!c//4*35x		Party that interacts with the delivering agent
O	:97A:	Safekeeping Account	SAFE		:4!c//35x		No. of securities acc. held with the party one step higher in the chain
O	:16S:	End of Block			16c	SETPRTY	
O	:16R:	Start of Block			16c	SETPRTY	
O	:95a:	Deliverer's Custodian	DECU	P R Q	:4!c//4!a2!a2!c[3!c] :4!c/8!c/34x :4!c//4*35x		Party that interacts with the delivering agent unless intermediaries exist
O	:97A:	Safekeeping Account	SAFE		:4!c//35x		No. of securities acc. held with the party one step higher in the chain
O	:16S:	End of Block			16c	SETPRTY	
O	:16R:	Start of Block			16c	SETPRTY	
O	:95a:	Seller	SELL	P R Q	:4!c//4!a2!a2!c[3!c] :4!c/8!c/34x :4!c//4*35x		Party that delivers the financial instrument
O	:97A:	Safekeeping Account	SAFE		:4!c//35x		No. of securities acc. held with the party one step higher in the chain
M	:16S:	End of Block			16c	SETPRTY	
<i>End of Subsequence E1 Settlement Parties</i>							
M	:16S:	End of Block			16c	SETDET	
<i>End of Sequence E Settlement Detail</i>							

3.2.2.1 Explanation of the SWIFT Fields

Sequence A – General Information

— :23G: - Function of the Message

The PREA/NEWM function will be replaced with Hold/Release in T2S. The PREA/NEWM function will remain available for submitting instructions in ISO 15022 format.

PREA: New instruction with On Hold = yes; The position is not released for settlement.

NEWM: New instruction with On Hold = no; The position is released for settlement. After a NEWM was submitted an MT530 or the Settlement Client must be used to change the On Hold setting.

CANC: Cancellation of the instruction.

— :99B: - Number Count

Instructions with a pool reference must include a pool counter indicating the total number of linked instructions.

SETT: Mandatory if the pool reference in the Optional Repetitive Subsequence A1 Linkages is filled.

TOSE: Mandatory if the pool reference in the Optional Repetitive Subsequence A1 Linkages is filled.

External-CSD Settlement: Linking of instructions is not possible.

— :22F: - Linkage Type Indicator

AFTE: Current instruction will be settled AFTER the linked-to instruction.

BEFO: Current instruction will be settled BEFORE the linked-to instruction.

WITH: Current instruction will be settled together WITH the linked-to instruction.

INFO: The LINK is added for informational purposes only and has no effects on the processing.

External-CSD Settlement: Linking of instructions is not possible.

Optional Repetitive Subsequence A1 Linkages

— :20C: - Reference

RELA: Customer reference of the referenced instruction (if A1:22F:LINK exists in this subsequence).

PREV: Customer reference of the instruction to be cancelled (in case of A:23G:CANC).

PREA: Customer reference of the instruction with PREA function (in case of A:23G:NEWM).

POOL: A pool reference can be used to link more than two instructions. It is a collective reference for a set of settlement instructions which must be settled collectively *"all-or-none"*.

COMM: Unique reference agreed between two counterparties to identify the instruction (optional matching field).

PCTI: In case of cancellation orders for instructions where the instructing party is different from the instructing party of the instruction being cancelled, this field has to contain the PCTI reference from the MT 548 status message.

- Instructions, which have been created by the OeKB CSD as instructing party (e.g. market claim or transformation)
- Instructions, which have been created by an authorised party but which are cancelled by the securities account owner

In addition the field :20C::PREV must be filled in with NONREF, because according to ISO 15022 SWIFT standard field :20C::PREV must be present, if field :23G: is CANC.

Mandatory Sequence B Trade Details

— :98A: - Date/Time

SETT: It is no longer possible to specify the exact time on the settlement day.

— :22F: - Priority Indicator

PRIR: When prioritising instructions it is possible to choose from 2 priority levels: High Priority (0003) and Normal Priority (0004). For details, please see *Annex 8 Guideline Settlement and Securities Account Administration*.

External-CSD Settlement: Prioritising of instructions is not possible.

— :22F: - Trade Transaction Condition Indicator

TTCO: This qualifier specifies whether the security is delivered with (CCPN – Cum Coupon) or without (XCPN – Ex Coupon) coupon (additional matching field).

External-CSD Settlement: This indicator is not used.

Mandatory Sequence C Financial Instrument/Account

— :97A: Safekeeping Account

The securities account number can be specified in the old format (e.g. 123400) or in the new format "OCSD + existing securities account number" (e.g. OCSD123400).

Optional Repetitive Subsequence C1 Quantity Breakdown

— :13B: - Lot Number

LOTS: To use a blocked/reserved position for an instruction this field must contain the restriction reference number.

External-CSD Settlement: This subsequence is not used.

Mandatory Sequence E Settlement Details

— :22F: -Settlement Transaction Condition Indicator

NPAR: Partial settlement of an instruction is not allowed.

PART: Partial settlement of an instruction is allowed.

PARQ: Partial Settlement is allowed with Minimum Quantity

PARC: Partial Settlement is allowed with Minimum Cash Value

NOMC: Opt-out indicator (additional matching field).

BSSP: Instruction Resulting from Partially Successful Buy-In. If the matching instruction is also instructed with this Settlement Transaction Condition both instructions will be exempt from Late Matching penalty fees. It is not a matching field.

For details, please see *Annex 8 Guideline Settlement and Securities Account Administration*.

External-CSD Settlement: Partial settlement is not possible.

— :22F: - Securities Sub-balance Type Indicator

SSBT: For this qualifier the use of Data Source Scheme "RT" (:4!c/RT/4!c) is compulsory.

For codes BLOn, RESn and EARn the rule "1<=n<=9", e.g. BLO1, BLO2,...., BLO9 applies. If SSBT is used a position with the corresponding restriction type (e.g. BLO1) must e.

Mandatory Repetitive Subsequence E1 Settlement Parties

— :95P: - Place of Settlement

PSET: For identification the BIC of the counterparty (depository) is used as the sole reference.

Exception: Transaction type external-CSD settlement – in this case the place of settlement must be specified as at present.

— :95P: - Receiving Agent

This field is used to identify the counterparty using the BIC.

— :97A: - Safekeeping Account

For transaction type external-CSD settlement this field must contain the securities account number as at present.

— :95a: - Receiver's Intermediary 2/Receiver's Intermediary 1/Receiving Custodian/ Buyer

It is possible to send all 5 parties (incl. REAG). Please note, however, that except in the case of REAG the following sequence must be observed for the parties: REI2, REI1, RECU, BUYR.

It is possible to shorten the chain, e.g. only BUYR or only REI1, RECU, BUYR but the sequence must be observed in all cases.

— :95a: - Deliverer's Intermediary 2/Deliverer's Intermediary 1/Deliverer's Custodian/ Seller

Aside from the optional DEAG, 4 additional parties can be specified on the deliverer side. For these 4 additional parties the following sequence must be observed: DEI2, DEI1, DECU, SELL.

It is possible to shorten the chain, e.g. only SELL or only DEI1, DECU, SELL but the sequence must be observed in all cases.

3.2.2.2 MT542 Example for Decrease

Transaction Type Decrease

:16R:GENL
:20C::SEME//HUA0710incrmt01
:23G:NEWM
:16S:GENL
:16R:TRADEDET
:98A::TRAD//20161007
:98A::SETT//20161007
:35B:ISIN AT0000A0ENT5
:16S:TRADEDET
:16R:FIAC
:36B::SETT//FAMT/10000,
:97A::SAFE//OCSD236500
:16S:FIAC
:16R:SETDET
:22F::SETR//MKDW
:16R:SETPRTY
:95P::PSET//OCSDATWWXXX
:16S:SETPRTY
:16R:SETPRTY
:95P::REAG//OCSDATWWXXX
:16S:SETPRTY
:16S:SETDET

3.2.3 MT546 – Deliver Free Confirmation

MT546 is the settlement confirmation for MT542 free of payment delivery instructions (DFP).

3.2.3.1 Content

M/O	Tag	Field Name	Qualifier	Option	Format	Codes	Description
Mandatory Sequence A General Information							
M	:16R:	Start of Block			16c	GENL	
M	:20C:	Sender's Reference	SEME		:4!c//16x		Reference assigned by the sender to unambiguously identify the message
M	:23G:				4!c	NEWM	New message

M/O	Tag	Field Name	Qualifier	Option	Format	Codes	Description
		Function of the Message				CANC	Message requesting the cancellation of a previously sent message.
M	:98C:	Preparation Date/Time	PREP		:4!c//8!n6!n		Date and time at which message was prepared.
O	:22F:	Partial Settlement Indicator	PARS		:4!c/[8c]/4!c	PAIN	Confirmation is for partial settlement. Part of the instruction remains unsettled.
						PARC	Confirmation is for partial settlement. No additional settlement will take place.

Optional Repetitive Subsequence A1 Linkages

M	:16R:	Start of Block			16c	LINK	
M	:20C:	Reference	RELA		:4!c//16x		Related Message Reference
			MITI				T2S Market Infrastructure Transaction Identification
			COMM				Common Reference
			POOL				Pool Reference
			PREV				Reference of the linked message which was previously sent.
			CORP				Corporate Action Reference
			PCTI				Processor Transaction Identification
M	:16S:	End of Block			16c	LINK	

End of Subsequence A1 Linkages

M	:16S:	End of Block			16c	GENL	
---	-------	--------------	--	--	-----	------	--

End of Sequence A General Information

Mandatory Sequence B Trade Details

M	:16R:	Start of Block			16c	TRADD ET	
---	-------	----------------	--	--	-----	-------------	--

M/O	Tag	Field Name	Qualifier	Option	Format	Codes	Description
O	:94H:	Place of Clearing	CLEA		:4!c//4!a2!a2!c[3!c]		
O	:94B:	Place of Trade	TRAD		:4!c//4!c[/30x]	EXCH	Place of trade is a stock exchange
						OTCO	Place of trade is over the counter.
						PRIM	Place of trade is the primary market.
						SECM	Place of trade is the secondary market.
						VARI	Trade was executed on various places.
O	:98a:	Trade Date/Time	TRAD	A	:4!c//8!n		Date at which the trade was executed.
				C	:4!c//8!n6!n		Date and time at which the trade was executed.
M	:98C:	Effective Settlement Date/Time	ESET		:4!c//8!n6!n		Date and time at which a transaction effectively settled.
O	:98A:	Settlement Date	SETT		:4!c//8!n		Date at which the financial instruments are to be delivered or received.
M	:35B:	Identification of the Financial Instrument			ISIN1!e12!c		"ISIN" followed by <Blank> and ISIN Code
O	:22F:	Priority Indicator	PRIR		:4!c//4!c	0001	Priority set by CSD or NCBs
						0002	Top priority (can only be assigned to trading platforms (MTFs, stock exchanges, etc.)
						0003	High priority
						0004	Normal priority
O	:22F:		TTCO		:4!c//4!c	CCPN	

M/O	Tag	Field Name	Qualifier	Option	Format	Codes	Description
		Trade Transaction Condition Indicator				XCPN	Trade was executed cum bonus. Trade was executed ex coupon.
O	:70E:	Narrative	SPRO		:4!c//10*35x		Provides additional settlement processing information which cannot be included within the structured fields of the message.
M	:16S:	End of Block			16c	TRADDET	
End of Sequence B Trade Details							
Mandatory Sequence C Financial Instrument/Account							
M	:16R:	Start of Block			16c	FIAC	
M	:36B:	Quantity of Financial Instrument Settled	ESTT		:4!c//4!c/15d	FAMT UNIT	Face amount Unit number
O	:36B:	Quantity of Financial Instrument Previously Settled	PSTT		:4!c//4!c/15d	FAMT UNIT	Face amount Unit number
O	:36B:	Quantity of Financial Instrument remaining to be settled.	RSTT		:4!c//4!c/15d	FAMT UNIT	Face amount Unit number
M	:97A:	Safekeeping Account	SAFE		:4!c//35x		OeKB CSD's securities account number of the customer
M	:16S:	End of Block			16c	FIAC	

M/O	Tag	Field Name	Qualifier	Option	Format	Codes	Description
End of Sequence C Financial Instrument/Account							
Mandatory Sequence E Settlement Details							
M	:16R:	Start of Block			16c	SETDET	
M	:22F:	Type of Settlement Transaction	SETR		:4!c/[8!c]/4!c	CLAI	Transaction resulting from a market claim.
						COLI	Relates to a collateral transaction, from the point of view of the collateral taker or its agent.
						COLO	Relates to a collateral transaction, from the point of view of the collateral giver or its agent.
						TRAD	Type of Settlement Transaction Indicator
						MKDW	Relates to the decrease of positions.
					:4!c/COEX/4!c	AUTO	Auto-collateralisation, in case of an Intra-day Restriction on the eligible ISIN
						CORP	Relates to a transaction generated as a result of a corporate action
						REBL	Rebalancing
O	:22F:	Settlement Transaction Condition Indicator	STCO		:4!c/[8c]/4!c	NPAR	Partial settlement is not allowed.
						PART	Partial settlement is allowed.
						NOMC	No market claim should be automatically generated.
						TRAN	Transaction resulting from a transformation.

M/O	Tag	Field Name	Qualifier	Option	Format	Codes	Description
					:4!c/COEX/4!c	PARQ	Partial Settlement is Allowed with Minimum Quantity
						PARC	Partial Settlement is Allowed with Minimum Cash Value
					:4!c/REGL/4!c	BSSP	Instruction Resulting from Partially Successful Buy-In
O	:22F:	Securities Sub-balance Type Indicator	SSBT		:4!c/[8c]/4!c	BLOn	Blocking
						RESn	Reservation
						EEUR	Earmarking for autocoll.
						EARn	Other earmarking
O	:22F:	Beneficial Ownership Indicator	BENE		:4!c/[8c]/4!c	NBEN	No Change of Beneficial Ownership (NCBO)
						YBEN	Change of Beneficial Ownership (CBO)
Mandatory Repetitive Subsequence E1 Settlement Parties							
M	:16R:	Start of Block			16c	SETPRT Y	
M	:95P:	Place of Settlement	PSET		:4!c//4!a2!a2!c[3!c]		Place of settlement (depository)
M	:16S:	End of Block			16c	SETPRT Y	
M	:16R:	Start of Block			16c	SETPRT Y	
M	:95P:	Receiving Agent	REAG		:4!c//4!a2!a2!c[3!c]		Receiving party that interacts with the place of settlement
(M)	:97A:	Safekeeping Account	SAFE		4!c//35x		Counterparty's securities acc. number

M/O	Tag	Field Name	Qualifier	Option	Format	Codes	Description
O	:20C:	Processing Reference	PROC		:4!c//16x		Counterparty's customer reference (not present for External Instructions)
M	:16S:	End of Block			16c	SETPRT Y	
O	:16R:	Start of Block			16c	SETPRT Y	
O	:95a:	Receiver's Intermediary 2	REI2	P	:4!c//4!a2!a2!c[3!c]		Party that interacts with the receiver's intermediary 1
				R	:4!c/8!c/34x		
				Q	:4!c//4*35x		
O	:16S:	End of Block			16c	SETPRT Y	
O	:16R:	Start of Block			16c	SETPRT Y	
O	:95a:	Receiver's Intermediary 1	REI1	P	:4!c//4!a2!a2!c[3!c]		Party that interacts with the receiving agent
				R	:4!c/8!c/34x		
				Q	:4!c//4*35x		
O	:16S:	End of Block			16c	SETPRT Y	
O	:16R:	Start of Block			16c	SETPRT Y	
O	:95a:	Receiver's Custodian	RECU	P	:4!c//4!a2!a2!c[3!c]		Party that interacts with the receiving agent unless intermediaries exist
				R	:4!c/8!c/34x		
				Q	:4!c//4*35x		
O	:16S:	End of Block			16c	SETPRT Y	
O	:16R:	Start of Block			16c	SETPRT Y	

M/O	Tag	Field Name	Qualifier	Option	Format	Codes	Description
O	:95a:	Buyer	BUYR	P	:4!c//4!a2!a2!c[3!c]		Party that receives the financial instrument
				R	:4!c/8!c/34x		
				Q	:4!c//4*35x		
O	:16S:	End of Block			16c	SETPRT Y	
O	:16R:	Start of Block			16c	SETPRT Y	
O	:95P:	Delivering Agent	DEAG		:4!c//4!a2!a2!c[3!c]	SETPRT Y	Delivering party that interacts with the place of settlement.
O	:16S:	End of Block			16c	SETPRT Y	
O	:16R:	Start of Block			16c	SETPRT Y	
O	:95a:	Deliverer's Intermediary 2	DEI2	P	:4!c//4!a2!a2!c[3!c]		Party that interacts with the deliverer's intermediary 1
				R	:4!c/8!c/34x		
				Q	:4!c//4*35x		
O	:16S:	End of Block			16c	SETPRT Y	
O	:16R:	Start of Block			16c	SETPRT Y	
O	:95a:	Deliverer's Intermediary 1	DEI1	P	:4!c//4!a2!a2!c[3!c]		Party that interacts with the delivering agent
				R	:4!c/8!c/34x		
				Q	:4!c//4*35x		
O	:16S:	End of Block			16c	SETPRT Y	
O	:16R:	Start of Block			16c	SETPRT Y	
O	:95a:	Deliverer's	DECU	P	:4!c//4!a2!a2!c[3!c]		

M/O	Tag	Field Name	Qualifier	Option	Format	Codes	Description
		Custodian		R	:4!c/8!c/34x		Party that interacts with the delivering agent unless intermediaries exist
				Q	:4!c//4*35x		
O	:16S:	End of Block			16c	SETPRT Y	
O	:16R:	Start of Block			16c	SETPRT Y	
O	:95a:	Seller	SELL	P	:4!c//4!a2!a2!c[3!c]		Party that delivers the financial instrument
				R	:4!c/8!c/34x		
				Q	:4!c//4*35x		
M	:16S:	End of Block			16c	SETPRT Y	
End of Subsequence E1 Settlement Parties							
M	:16S:	End of Block			16c	SETDET	
End of Sequence E Settlement Details							

User Manual for SWIFT ISO 20022

4. SWIFT Manual for Settlement ISO 20022

T2S uses the SWIFT ISO 20022 formats for the message exchange between the individual CSD customers, that is, full DCP mode customers and T2S. The standards of the ISO 20022 messages used by T2S are described in detail within the latest version of the User Detailed Functional Specification (UDFS).

Additional documentation has been published by the European Central Bank (ECB) on “My Standards” from SWIFT. “My Standards” can be accessed via the SWIFT website.

5. SWIFT Manual for Income and Corporate Actions ISO 20022

5.1 Introduction

This chapter describes the content of the new SWIFT message types for General Meetings (GM) and Shareholder Identification (SI) in SWIFT ISO 20022 in the context of the Shareholders Rights Directive II EU 2017/828 (SRD II), which is valid as of September 3rd, 2020.

In addition it describes how OeKB CSD can follow its responsibility to submit these messages to the securities account holder. Since the implementation of the full scope of the SRD II is a still ongoing process this manual will be continuously updated.

This chapter is still in progress and will be extended when technical changes are in place (e.g. new message types accepted).

5.2 Available message types in SWIFT ISO 20022:

Message	Notification Type	On BIC/ENDPOINT	Technical Specification
seev.001.001.09	MeetingNotification	OCSDATW2 (CUG)	swift
seev.002.001.08	MeetingCancellation	OCSDATW2 (CUG)	swift
seev.003.001.08	Meeting Entitlement Notification	OCSDATW2 (CUG)	swift
seev.008.001.07	MeetingResultDissemination	OCSDATW2 (CUG)	swift
seev.045.001.03	ShareholdersIdentificationDisclosureRequest	OCSDATW2 (CUG)	swift
seev.046.001.01	ShareholdersIdentificationDisclosureRequestCancellationAdvice	OCSDATW2 (CUG)	swift
seev.049.001.01	Shareholder Identification Disclosure Response Status Advice	OCSDATW2 (CUG)	swift

5.3 Communication Flow under Shareholders Rights Directive (SRD II)

Disclosure Request

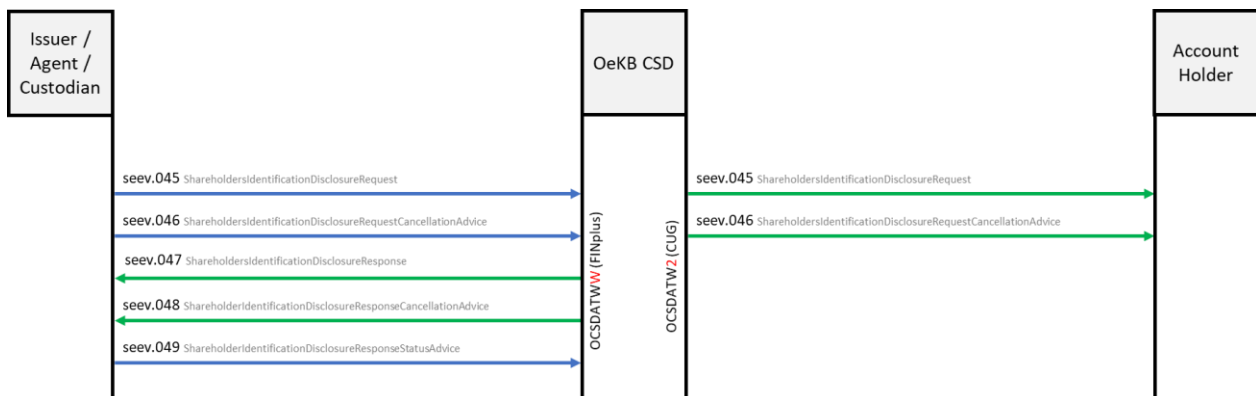

General Meetings

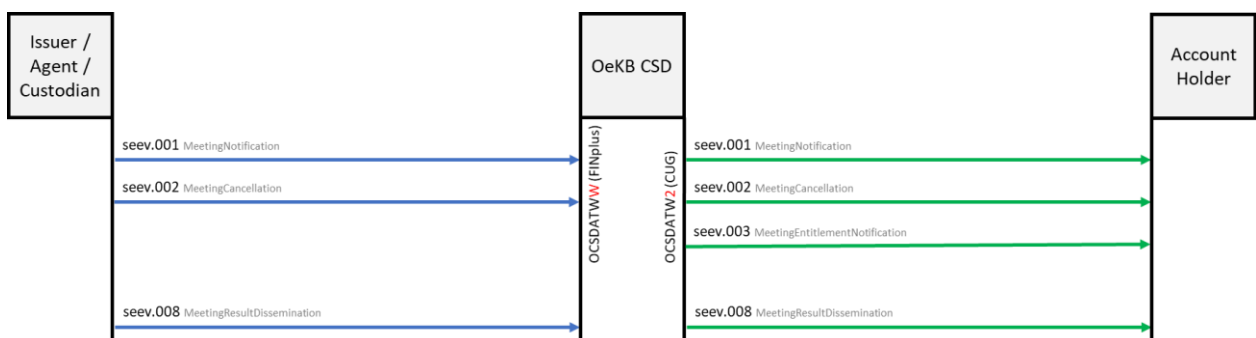

5.4 Incoming Messages SWIFT ISO 20022

5.4.1 Incoming Messages from Issuer/Issuer Agent/Custodian

OeKB CSD will receive several messages from the issuer/issuer agent/custodian as shown in the communication flow SWIFT ISO 20022. For further details please refer to the SWIFT Manual for Issuers.

5.4.2 Incoming Messages from Securities Account Holder

OeKB CSD **does not accept** any other message type or version on any BIC/ENDPOINT than described within the SWIFT Manual for Issuers and as shown in the Communication Flow SWIFT ISO 20022, **especially not:**

Event Type	Message	Notification Type	Reason
General Meeting	seev.004	Meeting Instruction	instructions and voting not be communicated via the chain but directly
General Meeting	seev.005	Meeting Instruction Cancellation Request	instructions and voting not be communicated via the chain but directly
General Meeting	seev.006	Meeting Instruction Status	instructions and voting not be communicated via the chain but directly
General Meeting	seev.007	Meeting Vote Execution Confirmation	instructions and voting not be communicated via the chain but directly
Disclosure Event	seev.047	Shareholders Identification Disclosure Response	responses to be sent to the recipient directly
Disclosure Event	seev.048	Shareholder Identification Disclosure Response Cancellation Advice	responses to be sent to the recipient directly

General Meetings – messages not in used

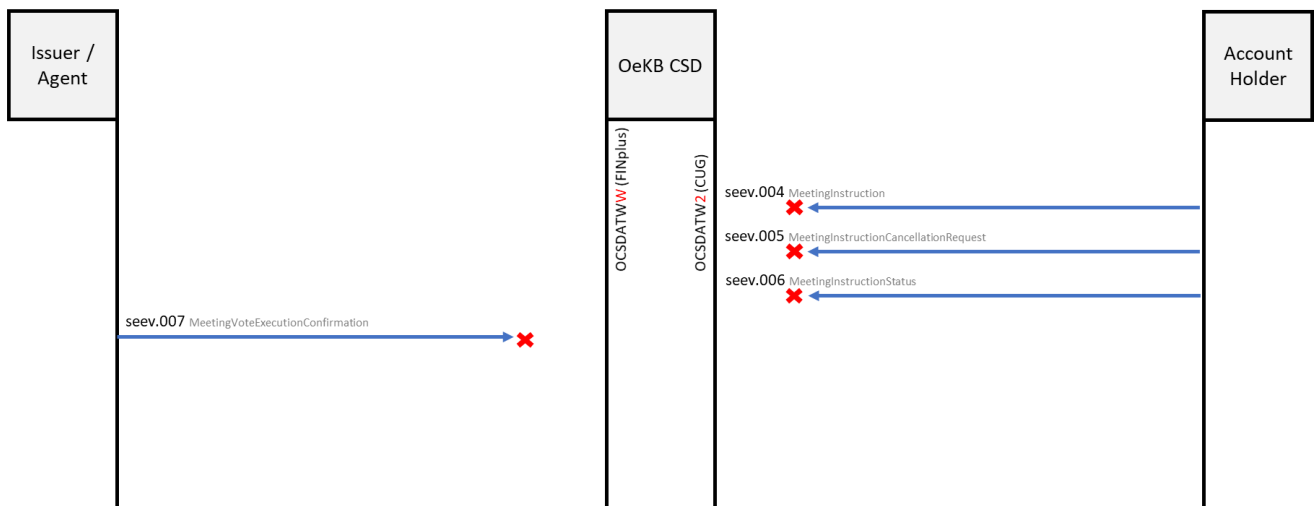

Disclosure Request– messages not in used

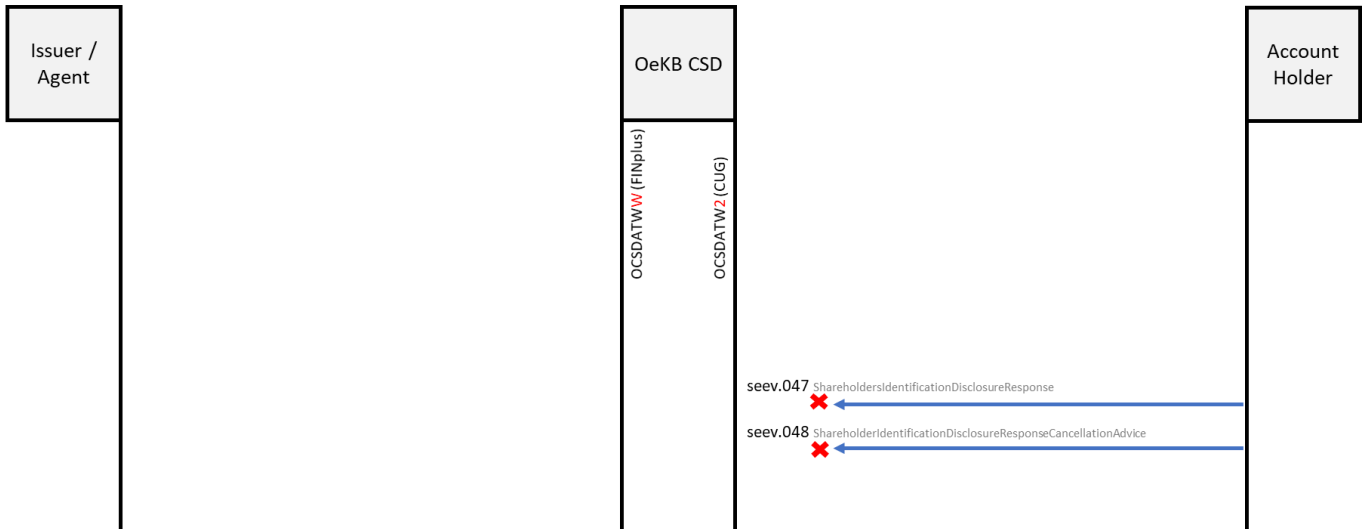

5.5 Outgoing Messages SWIFT ISO 2022

OeKB CSD will not provide the following notifications/information, since they are not in scope of the service:

General Meetings:

“Votes received”

“Votes recorded”

“Votes counted”

“Meeting results” will only be forwarded when received in SWIFT ISO 2022

5.5.1 Outbound seev.001.001.09 (Meeting Notification)

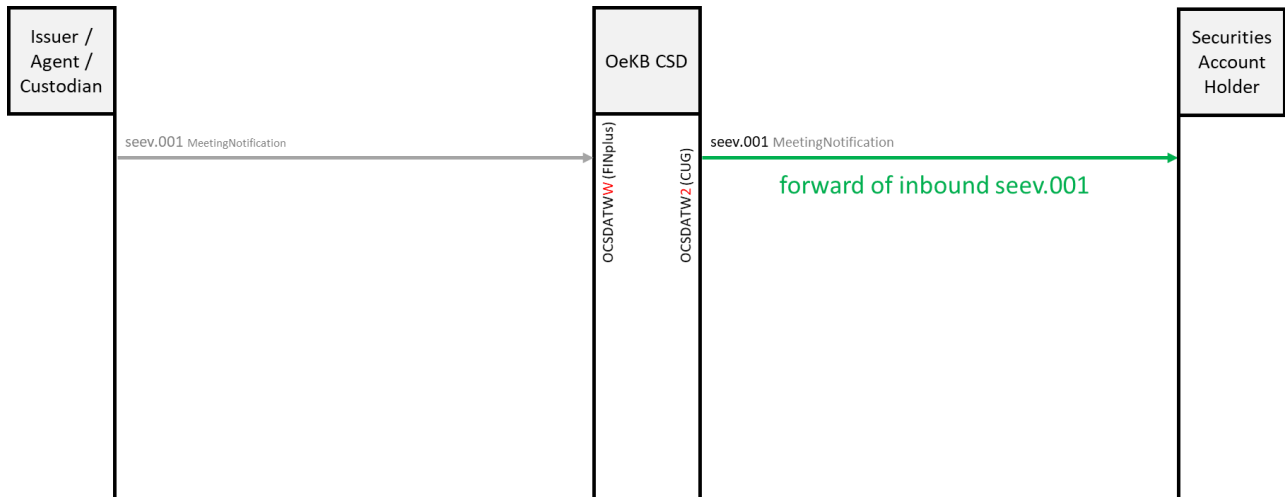

Please find below the official released descriptions by SMPG (fields not recommended by SMPG will not be considered in outgoing SWIFTs to the securities account holder, even if this information was received from the issuer/agent/custodian).

M/O: whether the field always is present/populated; **Mandatory:** always is populated; **Optional:** present/populated under certain conditions only

POS: position of field in message (**B**usiness Application Header or **D**ocument Body)

Element: semantic container (SWIFT ISO 20022 XML Tag)

Clarifications, Details and Element Constraints: additional information on the usage of the element as well as constraints that have to be met with respect to the element

M/O	POS	Element	Clarifications, Details and Element Constraints
M	B	From, <Fr>	BICFI (OCSDATW2)
M	B	To, <To>	BICFI (receiving securities account holder)
M	B	Business Message Identifier, <BizMsgIdr>	The sender's unique ID/reference of the message
M	B	Message Definition Identifier, <MsgDefldr>	seev.001.001.09

M/O	POS	Element	Clarifications, Details and Element Constraints
M	B	CreationDate, <CreDt>	Date and time, using ISONormalisedDateTime format,
Notification General Information			
M	D	Notification Type <NtfctnTp>	taken from INBOUND seev.001
M	D	Notification Status <NtfctnSts> – Event Completeness Status <EvtCmpltnsSts >	taken from INBOUND seev.001
M	D	Notification Status <NtfctnSts> – Event Confirmation Status <EvtConfSts>	taken from INBOUND seev.001
M	D	Shareholder Rights Directive Indicator <ShrhldrRghtsD rctvInd>	taken from INBOUND seev.001
Notification Update			
M	D	Previous Notification Identification <PrvsNtfctnId>	taken from INBOUND seev.001
M	D	Reconfirm Instructions <Rcnfrmlnstrs>	taken from INBOUND seev.001
Meeting			

M/O	POS	Element	Clarifications, Details and Element Constraints
M	D	Meeting Identification <MtgId>	taken from INBOUND seev.001
M	D	Issuer Meeting Identification <IssrMtgId>	taken from INBOUND seev.001
M	D	Type <Tp>	taken from INBOUND seev.001
M	D	Announcement Date <AnncmntDt>	taken from INBOUND seev.001
M	D	Participation – Participation Method <PrtcptnMtd>	taken from INBOUND seev.001
M	D	Participation – Issuer Deadline For Voting <IssrDdlInForVtn g>	taken from INBOUND seev.001
M	D	Additional Documentation URL Address <AddtlDcmnttn URLAdr>	taken from INBOUND seev.001
M	D	Entitlement Fixing Date <EntitlmntFxd t>	taken from INBOUND seev.001
M	D	Registration Participation Deadline <RegnPrtcptnD dln>	taken from INBOUND seev.001
M	D	Registration Participation	taken from INBOUND seev.001

M/O	POS	Element	Clarifications, Details and Element Constraints
		Market Deadline <RegnPrtcptnM ktDdln>	
Meeting Details			
M	D	Date And Time <DtAndTm>	taken from INBOUND seev.001
M	D	Quorum Required <QrmReqrd>	taken from INBOUND seev.001
M	D	Location <Lctn>	taken from INBOUND seev.001
M	D	Quorum Quantity <QrmQty>	taken from INBOUND seev.001
M	D	Issuer <Issr>	taken from INBOUND seev.001
	D	Security	taken from INBOUND seev.001
M	D	Financial Instrument Identification <FinInstrmId>	taken from INBOUND seev.001
M	D	Position – Account Identification <AcctId>	taken from INBOUND seev.001
	D	Resolution	taken from INBOUND seev.001
M	D	Issuer Label <IssrLabl>	taken from INBOUND seev.001
M	D	Description <Desc>	taken from INBOUND seev.001
M	D	Title <Titl>	taken from INBOUND seev.001

M/O	POS	Element	Clarifications, Details and Element Constraints
M	D	For Information Only <ForInfOnly>	taken from INBOUND seev.001
M	D	VoteType <VoteTp>	taken from INBOUND seev.001
M	D	Status <Sts>	taken from INBOUND seev.001
M	D	Vote Instruction Type <VoteInstrTp>	taken from INBOUND seev.001
M	D	URL Address <URLAdr>	taken from INBOUND seev.001
Vote			
M	D	Partial Vote Allowed <PrtlVoteAllwd>	taken from INBOUND seev.001
M	D	Split Vote Allowed <SplVoteAllwd>	taken from INBOUND seev.001
M	D	Vote Deadline <VoteDdlIn>	taken from INBOUND seev.001
M	D	Vote Market Deadline <VoteMktDdlIn>	taken from INBOUND seev.001
M	D	Vote Methods <VoteMthds>	taken from INBOUND seev.001
M	D	Beneficial Owner Disclosure <BnfclOwnrDsclsr>	taken from INBOUND seev.001
Events Linkage			

M/O	POS	Element	Clarifications, Details and Element Constraints
O	D	Event Identification <EvtId>	taken from INBOUND seev.001 (if present)
Meeting			
O	D	Classification <Clsfctn>	taken from INBOUND seev.001 (if present)
O	D	Attendance – Admission Conditions <AdmssnConds >	taken from INBOUND seev.001 (if present)
O	D	Attendance – Confirmation Information <ConfInf>	taken from INBOUND seev.001 (if present)
O	D	Attendance – Confirmation Deadline <ConfDdln>	taken from INBOUND seev.001 (if present)
O	D	Attendance – Confirmation Market Deadline <ConfMktDdln>	taken from INBOUND seev.001 (if present)
O	D	Additional Procedure Details – Additional Right	taken from INBOUND seev.001 (if present)
O	D	Securities Blocking Period End Date <SctiesBlckgPrd EndDt>	taken from INBOUND seev.001 (if present)
O	D	Registration Securities Deadline	taken from INBOUND seev.001 (if present)

M/O	POS	Element	Clarifications, Details and Element Constraints
		<RegnSctiesDdl n>	
O	D	Registration Securities Market Deadline <RegnSctiesMkt DdlIn>	taken from INBOUND seev.001 (if present)
O	D	Processing Text For Next Intermediary <PrgTtxtForNxt Intrmy>	taken from INBOUND seev.001 (if present)
O	D	Neutral Proxy [NEPR]	taken from INBOUND seev.001 (if present)
Meeting Details			
O	D	DateStatus <DtSts>	taken from INBOUND seev.001 (if present)
Security			
O	D	Holding Balance <HldgBal>	taken from INBOUND seev.001 (if present)
Resolution			
O	D	Submitted By Security Holder <SubmittdBySct yHldr>	taken from INBOUND seev.001 (if present)
O	D	Management Recommendati on <MgmtRcmmn dtn>	taken from INBOUND seev.001 (if present)
O	D	Voting Rights Threshold For Approval	taken from INBOUND seev.001 (if present)

M/O	POS	Element	Clarifications, Details and Element Constraints
		<VtngRghtsThrs hldForApprvl>	

5.5.2 Outbound seev.002.001.08 (MeetingCancellation)

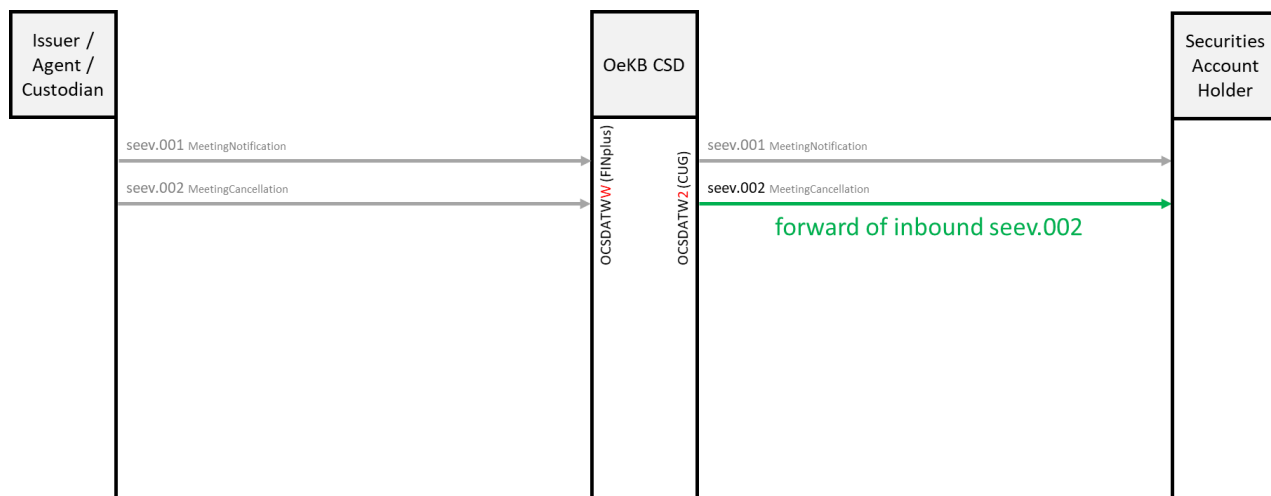

Please find below the official released descriptions by SMPG (fields not recommended by SMPG will not be considered in outgoing SWIFTS to the securities account holder, even if this information was received from the issuer/agent/custodian).

M/O	POS	Element	Clarifications, Details and Element Constraints
M	B	From, <Fr>	BICFI (OCSDATW2)
M	B	To, <To>	BICFI (receiving securities account holder)
M	B	Business Message Identifier, <BizMsgIdr>	The sender's unique ID/reference of the message
M	B	Message Definition Identifier, <MsgDefIdr>	seev.002.001.08
M	B	Creation Date, <CreDt>	Date and time, using ISO Normalised DateTime format
Meeting Reference			
M	D	Meeting Identification <MtgId>	taken from INBOUND seev.002
M	D	Issuer Meeting Identification <IssrMtgId>	taken from INBOUND seev.002

M/O	POS	Element	Clarifications, Details and Element Constraints
M	D	Type <Tp>	taken from INBOUND seev.002
Security			
M	D	Financial Instrument Identification <FinInstrmId>	taken from INBOUND seev.002
M	D	Position – Account Identification <AcctId>	taken from INBOUND seev.002
Reason			
M	D	Cancellation Reason Code <CxIRsnCd>	taken from INBOUND seev.002
Meeting Reference			
O	D	MeetingDateAndTime <MtgDtAndTm>	taken from INBOUND seev.002 (if present)

5.5.3 Outbound seev.008.001.07 (MeetingResultDissemination)

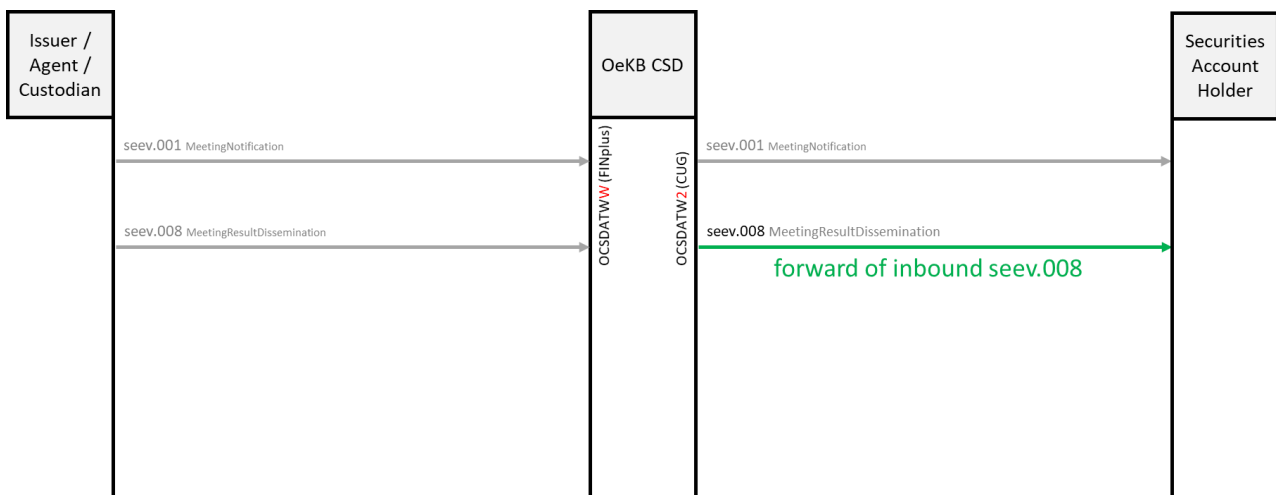

Please find below the official released descriptions by SMPG (fields not recommended by SMPG will not be considered in outgoing SWIFTS to the securities account holder, even if this information was received from the issuer/agent/custodian).

M/O	POS	Element	Clarifications, Details and Element Constraints
M	B	From, <Fr>	BICFI (OCSDATW2)
M	B	To, <To>	BICFI (receiving securities account holder)

M/O	POS	Element	Clarifications, Details and Element Constraints
M	B	Business Message Identifier, <BizMsgldr>	
M	B	Message Definition Identifier, <MsgDefldr>	seev.008.001.07
M	B	CreationDate, <CreDt>	Date and time, using ISONormalisedDateTime format

Meeting Results Dissemination Type

M	D	MeetingResults DisseminationType <MtgRsItsDssmntnTp>	taken from INBOUND seev.008
---	---	--	-----------------------------

Meeting Reference

M	D	MeetingIdentification <MtglD>	taken from INBOUND seev.008
M	D	IssuerMeetingIdentification <IssrMtglD>	taken from INBOUND seev.008
M	D	MeetingDateAndTime <MtgDtAndTm>	taken from INBOUND seev.008
M	D	Type <Tp>	taken from INBOUND seev.008

Security (the Message Building Block is repetitive, but recommended to only include one Security block per meeting event).

M	D	FinancialInstrumentIdentification <FinInstrmId>	taken from INBOUND seev.008
---	---	---	-----------------------------

M/O	POS	Element	Clarifications, Details and Element Constraints
M	D	Position – AccountIdentification <AcctId>	taken from INBOUND seev.008
Vote Result			
M	D	IssuerLabel <IssrLabl>	taken from INBOUND seev.008
M	D	ResolutionStatus <RsltnSts>	taken from INBOUND seev.008
Meeting Reference			
O	D	Classification <Clssfctn>	taken from INBOUND seev.008 (if present)
Vote Result			
O	D	For <For>	taken from INBOUND seev.008 (if present)
O	D	Against <Agnst>	taken from INBOUND seev.008 (if present)
O	D	Abstain <Abstn>	taken from INBOUND seev.008 (if present)
O	D	Withhold <Wthhld>	taken from INBOUND seev.008 (if present)
O	D	WithManagement <WthMgmt>	taken from INBOUND seev.008 (if present)
O	D	AgainstManagement <AgnstMgmt>	taken from INBOUND seev.008 (if present)
O	D	Discretionary <Dscrtnry>	taken from INBOUND seev.008 (if present)
O	D	OneYear <OneYr>	taken from INBOUND seev.008 (if present)
O	D	TwoYears <TwoYrs>	taken from INBOUND seev.008 (if present)
O	D	ThreeYears <ThreeYrs>	taken from INBOUND seev.008 (if present)

M/O	POS	Element	Clarifications, Details and Element Constraints
O	D	NoAction <NoActn>	taken from INBOUND seev.008 (if present)
O	D	Blank <Blnk>	taken from INBOUND seev.008 (if present)

Participation

O	D	TotalNumberOf VotingRights <TtINbOfVtngR ghts>	taken from INBOUND seev.008 (if present)
---	---	---	--

5.5.4 Outbound seev.045.001.03 (ShareholdersIdentificationDisclosureRequest)

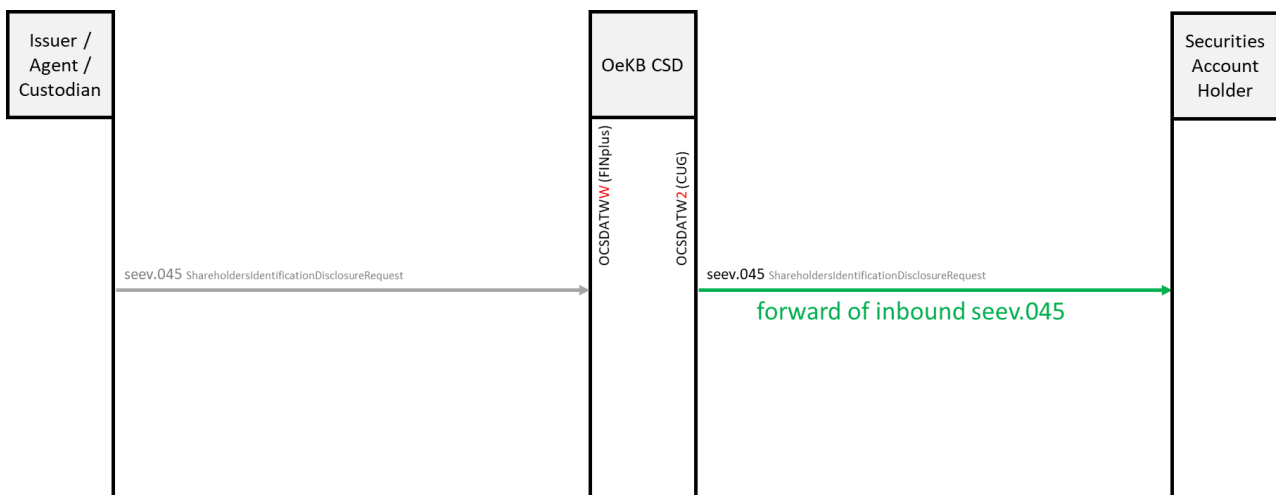

Please find below the official released descriptions by SMPG (fields not recommended by SMPG will not be considered in outgoing SWIFTS to the securities account holder, even if this information was received from the issuer/agent/custodian).

M/O	POS	Element	Clarifications, Details and Element Constraints
M	B	From, <Fr>	BICFI (OCSDATW2)
M	B	To, <To>	BICFI (receiving securities account holder)
M	B	BusinessMessa geldentifier, <BizMsgldr>	

M/O	POS	Element	Clarifications, Details and Element Constraints
M	B	MessageDefinitonIdentifier, <MsgDefldr>	seev.045.001.03
M	B	CreationDate, <CreDt>	Date and time, using ISONormalisedDateTime format
M	D	Issuer Disclosure Request Identification, <IssrDsclsrReqld>	taken from INBOUND seev.045
M	D	Disclosure Request Type, <DsclsrReqTp>	taken from INBOUND seev.045
M	D	Forward Request Indicator, <FwdReqInd>	taken from INBOUND seev.045
M	D	ShareholderRig htsDirectiveIndi cator <ShrhldrRghtsD rctvInd>	taken from INBOUND seev.045
M	D	Financial Instrument Identification, <FinInstrmld>	taken from INBOUND seev.045
M	D	Shareholders Disclosure Record Date , <ShrhldrsDsclsr RcrdDt >	taken from INBOUND seev.045
M	D	Disclosure Response Recipient -	taken from INBOUND seev.045

M/O	POS	Element	Clarifications, Details and Element Constraints
		Identification, <Id>	
M	D	Disclosure Response Recipient - Recipient Name, <RcptNm>	taken from INBOUND seev.045
M	D	Disclosure Response Recipient - Response Recipient Address, <RspnRcptAdr>	taken from INBOUND seev.045
M	D	Issuer Disclosure Deadline, <IssrDsclsrDdln >	taken from INBOUND seev.045.001.02
O	D	Response Through Chain Indicator, <RspnThrhCha inInd>	taken from INBOUND seev.045 (if present), although the indicator will be ignored by OeKB CSD. Response through the chain is not supported.
O	D	Shares Quantity Threshold, <ShrsQtyThrshl d>	taken from INBOUND seev.045 (if present)
O	D	Request Share Held Date, <ReqShrHeldDt >	taken from INBOUND seev.045 (if present)

M/O	POS	Element	Clarifications, Details and Element Constraints
O	D	Date Calculation Method, <DtClctnMtd>	taken from INBOUND seev.045 (if present)
O	D	Disclosure Response Deadline <DsclsrRspnDdl n>	taken from INBOUND seev.045 (if present)

5.5.5 Outbound seev.046.001.01 (ShareholdersIdentificationDisclosureRequestCancellationAdvice)

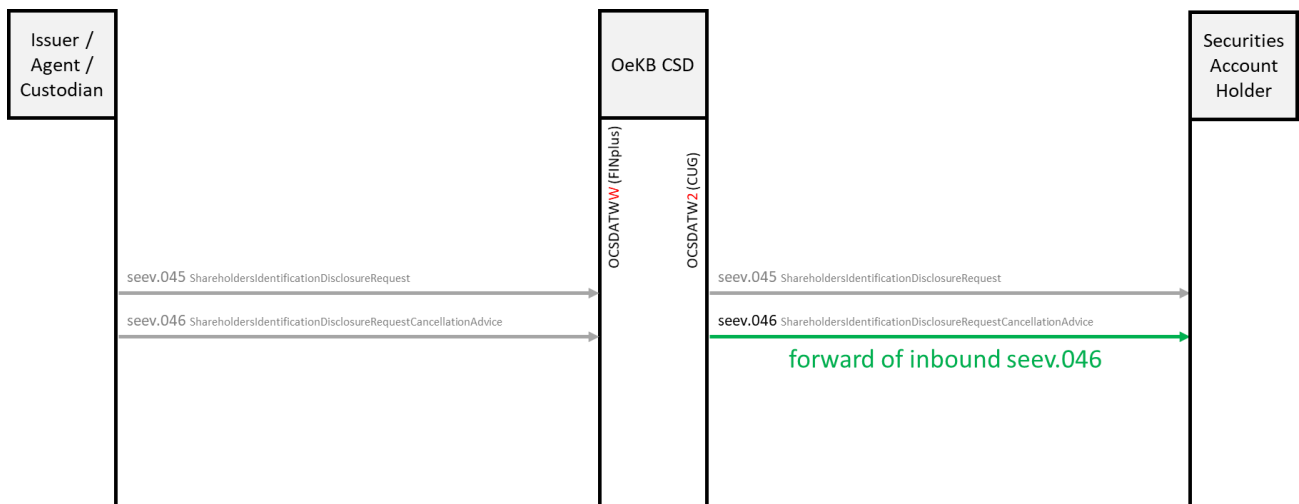

Please find below the official released descriptions by SMPG (fields not recommended by SMPG will not be considered in outgoing SWIFTS to the securities account holder, even if this information was received from the issuer/agent/custodian).

M/O	POS	Element	Clarifications, Details and Element Constraints
M	B	From, <Fr>	BICFI (OCSDATW2)
M	B	To, <To>	BICFI (receiving securities account holder)
M	B	BusinessMessageIdentifier, <BizMsgIdr>	
M	B	MessageDefinitionIdentifier, <MsgDefIdr>	seev.046.001.01
M	B	CreationDate, <CreDt>	Date and time, using ISO NormalisedDateTime format
M	D	Issuer Disclosure Request Identification, <IssrDsclsrReqId>	taken from INBOUND seev.046.
M	D	Financial Instrument Identification, <FinInstrmId>	taken from INBOUND seev.046
M	D	Shareholders Disclosure Record Date, <ShrhldrsDsclsrRcdDt>	taken from INBOUND seev.046
M	D	CancellationReason, <CxlRsn>	taken from INBOUND seev.046
O	B	Related – From, <Fr>	taken from INBOUND seev.046 (if present)
O	B	Related – To, <To>	taken from INBOUND seev.046 (if present)
O	B	Related – BusinessMessageIdentifier, <BizMsgIdr>	taken from INBOUND seev.046 (if present)

M/O	POS	Element	Clarifications, Details and Element Constraints
O	B	Related – MessageDefinitionI dentifier, <MsgDefldr>	taken from INBOUND seev.046 (if present)
O	B	Related – CreationDate, <CreDt>	taken from INBOUND seev.046 (if present)

6. SWIFT Manual for Issuers ISO 20022

6.1 Issuer Agent – Information Provider

Issuers have the possibility to authorize an Information Provider for submitting information to OeKB CSD for the safekeeping and administration with regard to General Meetings and Disclosure Requests. Therefore a legally binding form signed by the Issuer has to be sent according to Annex 10 Authorization Information Provider, see also section 2.6 (3) GTC of OeKB CSD.

6.2 Incoming SWIFT ISO 20022 Messages

The following message types can be accepted by OeKB CSD:

Message Type	Notification Type	On BIC/ENDPOINT	Technical Specification
seev.001.001.09	MeetingNotification	OCSDATWW (FINplus)	swift
seev.002.001.08	MeetingCancellation	OCSDATWW (FINplus)	swift
seev.008.001.07	MeetingResultDissemination	OCSDATWW (FINplus)	swift
seev.045.001.03	ShareholdersIdentificationDisclosureRequest	OCSDATWW (FINplus)	swift
seev.046.001.01	ShareholdersIdentificationDisclosureRequestCancellationAdvice	OCSDATWW (FINplus)	swift
seev.049.001.01	ShareholderIdentificationDisclosureResponseStatusAdvice	OCSDATWW (FINplus)	swift

Restrictions:

OeKB CSD does not accept any BIC/ENDPOINT not stated in the above list.

OeKB CSD does not accept any messages stated in the above list not meeting the SWIFT ISO 20022 format and semantics constraints.

OeKB CSD does not accept any messages stated in the above list not meeting the constraints outlined below.

OeKB CSD reserves the right to tacitly strip any information from accepted message if this information either

- exceeds the supported elements explicitly listed below or
- does not meet the general as well as element level constraints outlined below.

6.2.1 seev.001.001.09 (MeetingNotification9)

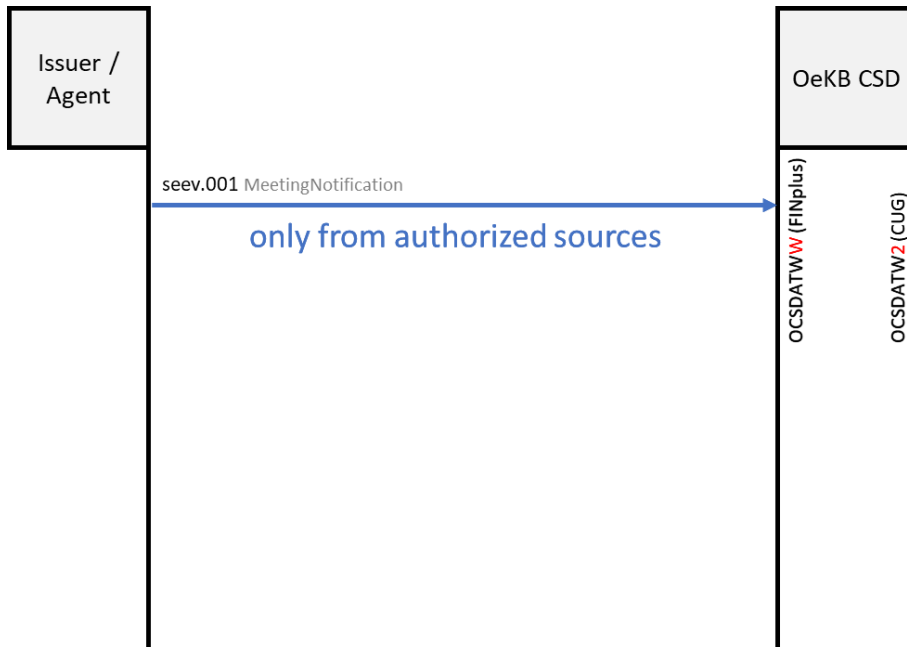

Please find below the official released descriptions by SMPG (fields not recommended by SMPG will not be considered in outgoing SWIFTS):

M/O: whether the field must be populated; **Mandatory**: must be populated for the message to be processed properly; **Optional**: processed if populated; any field **not** listed may tacitly be dropped during processing

POS: position of field in message (**B**usiness Application Header or **D**ocument Body)

Element: semantic container (ISO20022 XML Tag)

Clarifications, Details and Element Constraints: additional information on the usage of the element as well as constraints that have to be met with respect to the element

M/O	POS	Element	Clarifications, Details and Element Constraints
M	B	From, <Fr>	The sender from a business context, which can be different than the actual sender in the transport header (similar to MEOR in MT). BICFI is the only accepted format.
M	B	To, <To>	The receiver from a business context, which can be different than the actual receiver in the transport header (similar to MERE in MT). BICFI is the only accepted format.
M	B	Business Message	The sender's unique ID/reference of the message

M/O	POS	Element	Clarifications, Details and Element Constraints
		Identifier, <BizMsgIdr>	
M	B	Message Definition Identifier, <MsgDefldr>	Contains the MessageIdentifier that defines the BusinessMessage, e.g. <seev.001.001.09>
M	B	CreationDate, <CreDt>	Date and time, using ISONormalisedDateTime format,

Notification General Information

M	D	Notification Type <NtfctnTp>	<p>A <REPL> message should only be sent in case of a change in the previously announced general meeting notification.</p> <p>A <RMDR> can be sent by an account servicer to an account owner who has not responded providing its participation in a general meeting. This flow is optional and usage/timing is left to SLA.</p>
M	D	Notification Status <NtfctnSts> – Event Completeness Status <EvtCmpltnsSts>	As per global market practice, a Notification message may be considered complete when there are sufficient details for the client to make a decision.
M	D	Notification Status <NtfctnSts> – Event Confirmation Status <EvtConfSts>	A Notification message is considered confirmed when officially announced by the issuer.
M	D	Shareholder Rights Directive Indicator <ShrhldrRghtsDr ctvInd>	<p>This indicator should be set to YES (value “true”) only when the general meeting is in scope of SRD II and the notification has been received from the issuer CSD or first intermediary, which in turn it has received it from the issuer.</p> <p>Any other intermediary in the chain should report the value of this</p>

M/O	POS	Element	Clarifications, Details and Element Constraints
			<p>indicator as per the value received from the previous intermediary.</p> <p>When the indicator is set to NO, the notification is to be intended as in scope of SRD II but not received from the issuer CSD or first intermediary or the issuer.</p> <p>If the general meeting is outside the scope of SRD II, this indicator should not be populated.</p>
Notification Update			
M	D	Previous Notification Identification <PrvsNtfctnId>	It should always be present when sending a REPL or RMDR
M	D	Reconfirm Instructions <RcnfrmInstrs>	This indicator should be set to YES (value "true") only if previously received meeting instructions can no longer be processed due to changes in the agenda or resolutions and new instructions are accordingly required.
Meeting			
M	D	Meeting Identification <MtgId>	This is the account servicer identification for the general meeting. It is recommended to be used in all cases, even if the issuer has provided an identification
M	D	Issuer Meeting Identification <IssrMtgId>	It must always be used, if provided by the issuer (its agent or third party nominated by it)
M	D	Type <Tp>	
M	D	Announcement Date <AnncmntDt>	As announced by the issuer

M/O	POS	Element	Clarifications, Details and Element Constraints
M	D	Participation – Participation Method <PrtcptnMtd>	This should be used to report the participation method supported by the issuer. Code is the only accepted format. Please refer to the table at the end of this section to understand how participation method and vote methods should be used.
M	D	Participation – Issuer Deadline For Voting <IssrDdlnForVtng >	To be populated with: · meeting date for PHYS, PNHV & VIRT · issuer deadline for MAIL, PRXY & EVOT DateTime in UTC format is the only accepted format (YYYY-MM-DDThh:mm:ss.sssZ (Z means Zulu Time ≡ UTC time ≡ zero UTC offset))
M	D	Additional Documentation URL Address <AddtlDcmnttnURLAdr>	It should carry the URL to the issuer website where full information on the general meeting is provided.
M	D	Entitlement Fixing Date <EntitlmntFvgDt >	DateMode should not be used as record date should always be end of day.
M	D	Registration Participation Deadline <RegnPrtcptnDdln>	To report the account servicer deadline by which the rights holder needs to register its intention to participate in the meeting process to be allowed to participate in the meeting event. DateTime in UTC format is the only accepted format (YYYY-MM-DDThh:mm:ss.sssZ (Z means Zulu Time ≡ UTC time ≡ zero UTC offset))
M	D	Registration Participation Market Deadline <RegnPrtcptnMktDdln>	To report the issuer deadline by which the rightsholder needs to register its intention to participate in the meeting process to be allowed to participate in the meeting event. DateTime in UTC format is the only accepted format (YYYY-MM-DDThh:mm:ss.sssZ (Z means Zulu Time ≡ UTC time ≡ zero UTC offset))

Meeting Details

M/O	POS	Element	Clarifications, Details and Element Constraints
M	D	Date And Time <DtAndTm>	DateTime in UTC format is the only accepted format (YYYY-MM-DDThh:mm:ss.sssZ (Z means Zulu Time ≡ UTC time ≡ zero UTC offset))
M	D	Quorum Required <QrmReqr>	
M	D	Location <Lctn>	
M	D	Quorum Quantity <QrmQty>	To be reported if QuorumRequired is set to YES
M	D	Issuer <Issr>	NameAndAddress is the only accepted format
	D	Security	
M	D	Financial Instrument Identification <FinInstrmId>	ISIN is the only accepted format. Separate meeting event per ISIN
M	D	Position – Account Identification <AcctId>	Possible market practices: · one message per safekeeping account · one message per client (without any mentioning of the safekeeping account details (equal to GENR in CA) without opening the Position block) · one message repeating account details in the Position block
M	D	Resolution	Number of resolution
M	D	Issuer Label <IssrLabl>	

M/O	POS	Element	Clarifications, Details and Element Constraints
M	D	Description <Desc>	<p>Where the issuer announce the resolution items in both the national language and English, we recommend that the resolutions include both languages, at the same time, in any notification message. Each language should be preceded by the ISO 639-1 code of the language.</p> <p>If for any reason, the resolutions are not announced in both languages at the same time, once the details in the other language are announced, a replacement message (REPL) should be issued with the resolutions updated to include the wording in such language.</p>
M	D	Title <Titl>	<p>Where the issuer announce the resolution items in both the national language and English, we recommend that the resolutions include both languages, at the same time, in any notification message. Each language should be preceded by the ISO 639-1 code of the language.</p> <p>If for any reason, the resolutions are not announced in both languages at the same time, once the details in the other language are announced, a replacement message (REPL) should be issued with the resolutions updated to include the wording in such language.</p>
M	D	For Information Only <ForInfOnly>	
M	D	VoteType <VoteTp>	
M	D	Status <Sts>	
M	D	Vote Instruction Type <VoteInstrTp>	Type is the only accepted format.
M	D	URL Address <URLAdr>	To be reported only if provided by the issuer

Vote

M/O	POS	Element	Clarifications, Details and Element Constraints
M	D	Partial Vote Allowed <PrtlVoteAllwd>	
M	D	Split Vote Allowed <SpltVoteAllwd>	
M	D	Vote Deadline <VoteDdln>	To be used to report the account servicer deadline for vote through network. DateTime in UTC format is the only accepted format (YYYY-MM-DDThh:mm:ss.sssZ (Z means Zulu Time ≡ UTC time ≡ zero UTC offset))
M	D	Vote Market Deadline <VoteMktDdln>	To be used to report the issuer CSD or market platform deadline for electronic vote. DateTime in UTC format is the only accepted format (YYYY-MM-DDThh:mm:ss.sssZ (Z means Zulu Time ≡ UTC time ≡ zero UTC offset))
M	D	Vote Methods <VoteMthds>	Intended as the direction/address where the vote should be sent to – please refer to the table below to identify how the vote method should be applied based on the participation method. If vote through network is not populated, then the account servicer is not supporting the vote or attendance. The vote deadline will also not be included.
M	D	Beneficial Owner Disclosure <BnfclOwnrDsclsr>	
Events Linkage			
O	D	Event Identification <EvtId>	To be used to report the details of another general meeting. IssuerMeetingIdentification is the only accepted format.

M/O	POS	Element	Clarifications, Details and Element Constraints
Meeting			
O	D	Classification <Clsfctn>	Only Code is permitted.
O	D	Attendance – Admission Conditions <AdmssnConds>	Code is the only accepted format. It should only be used if the method of participation is PHYS or VIRT.
O	D	Attendance – Confirmation Information <ConfInf>	It should be used to specify how the rightsholder should order the attendance card or to give notice of attendance. It should only be used if the method of participation is PHYS or VIRT
O	D	Attendance – Confirmation Deadline <ConfDdln>	It indicates the account servicer deadline to request attendance. DateTime in UTC format is the only accepted format (YYYY-MM-DDThh:mm:ss.sssZ (Z means Zulu Time ≡ UTC time ≡ zero UTC offset)) It should only be used if the method of participation is PHYS or VIRT
O	D	Attendance – Confirmation Market Deadline <ConfMktDdln>	It indicates the issuer deadline to request attendance. DateTime in UTC format is the only accepted format (YYYY-MM-DDThh:mm:ss.sssZ (Z means Zulu Time ≡ UTC time ≡ zero UTC offset)) It should only be used if the method of participation is PHYS or VIRT
O	D	Additional Procedure Details – Additional Right <AddtlRghtDdln>	In case of additional rights that can be exercised at the meeting, we recommend to at least use AdditionalRightDeadline <AddtlRghtDdln> and AdditionalRightMarketDeadline<AddtlRghtMktDdln>. DateTime in UTC format is the only accepted format (YYYY-MM-DDThh:mm:ss.sssZ (Z means Zulu Time ≡ UTC time ≡ zero UTC offset))

M/O	POS	Element	Clarifications, Details and Element Constraints
O	D	Securities Blocking Period End Date <SctiesBlckgPrdEndDt>	In line with SRDI & II, this should be equal to record date
O	D	Registration Securities Deadline <RegnSctiesDdIn>	To be used in those markets where shares need to be re-registered in order to vote/attend. DateTime in UTC format is the only accepted format (YYYY-MM-DDThh:mm:ss.sssZ (Z means Zulu Time ≡ UTC time ≡ zero UTC offset)).
O	D	Registration Securities Market Deadline <RegnSctiesMktDdIn>	To be used in those markets where shares need to be re-registered in order to vote/attend. DateTime in UTC format is the only accepted format (YYYY-MM-DDThh:mm:ss.sssZ (Z means Zulu Time ≡ UTC time ≡ zero UTC offset))
O	D	Processing Text For Next Intermediary <PrcgTxtForNxtlntnrmty>	taken from INBOUND seev.001 (if present)
O	D	Neutral Proxy [NEPR]	taken from INBOUND seev.001 (if present)
Meeting Details			
O	D	DateStatus <DtSts>	
Security			
O	D	Holding Balance <HldgBal>	For NEWM and REPL messages sent before record date, it's strongly recommend not to report the ELIG balance type. For RMDR messages sent after record date, it's recommended to report ELIG, UNBA and INBA balance types.

M/O	POS	Element	Clarifications, Details and Element Constraints
			For RMDR messages sent before record date, the ELIG balance type can be included, along with UNBA and INBA, but it has to be considered as provisional as the message is sent prior to entitlement date.
Resolution			
O	D	Submitted By Security Holder <SubmittdBySctyHldr>	Only to be used if set to YES
O	D	Management Recommendation <MgmtRcmmndtn>	Only to be used for resolutions submitted by rightholders or any other party that is not the management
O	D	Voting Rights Threshold For Approval <VtngRghtsThrshldForApprvl>	Only to be used to report a threshold. Percentage is the permitted format.

6.2.2 seev.002.001.08 (MeetingCancellation)

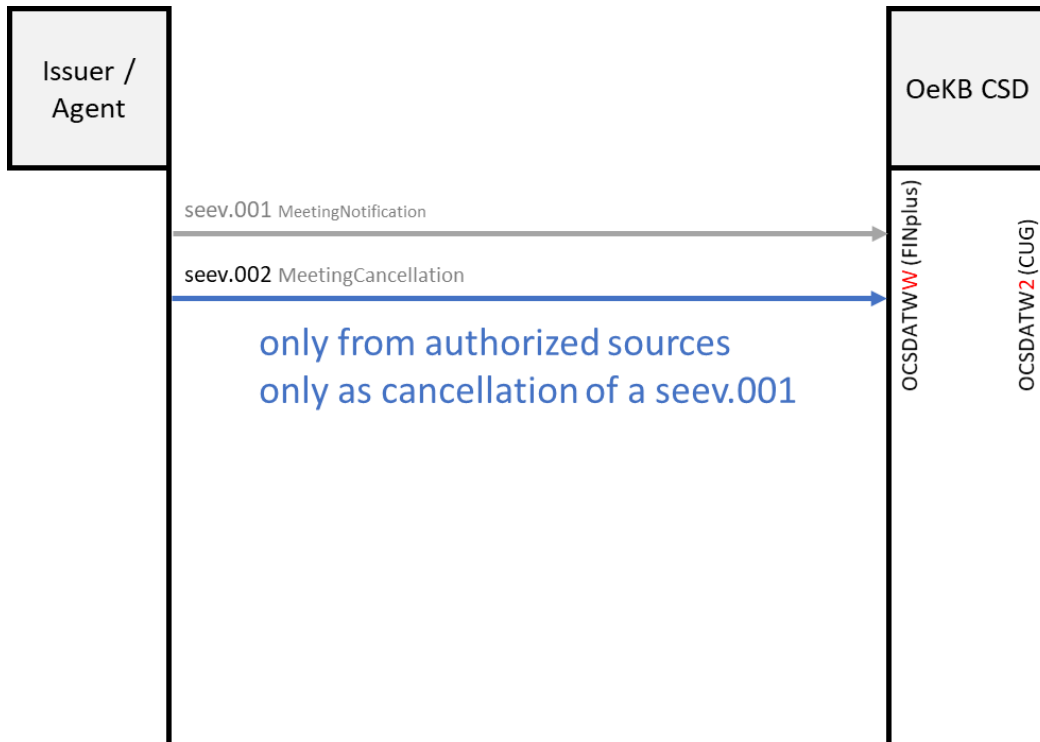

Please find below the official released descriptions by SMPG (fields not recommended by SMPG will not be considered in outgoing SWIFTS):

M/O: whether the field must be populated; **Mandatory**: must be populated for the message to be processed properly; **Optional**: processed if populated; any field **not** listed may tacitly be dropped during processing

POS: position of field in message (**B**usiness Application Header or **D**ocument Body)

Element: semantic container (ISO20022 XML Tag)

Clarifications, Details and Element Constraints: additional information on the usage of the element as well as constraints that have to be met with respect to the element

M/O	POS	Element	Clarifications, Details and Element Constraints
M	B	From, <Fr>	The sender from a business context, which can be different than the actual sender in the transport header (similar to MEOR in MT). BICFI is the only accepted format.
M	B	To, <To>	The receiver from a business context, which can be different than the actual receiver in the transport header (similar to MERE in MT). BICFI is the only accepted format.

M/O	POS	Element	Clarifications, Details and Element Constraints
M	B	Business Message Identifier, <BizMsgIdr>	The sender's unique ID/reference of the message
M	B	Message Definition Identifier, <MsgDefldr>	Contains the MessageIdentifier that defines the BusinessMessage, e.g. seev.002.001.08
M	B	Creation Date, <CreDt>	Date and time, using ISONormalisedDateTime format

Meeting Reference

M	D	Meeting Identification <MtgId>	This is the account servicer identification for the general meeting. It is recommended to be used in all cases, even if the issuer has provided an identification
M	D	Issuer Meeting Identification <IssrMtgId>	It must always be used, if provided by the issuer.
M	D	Type <Tp>	

Security

M	D	Financial Instrument Identification <FinInstrmId>	ISIN is the only accepted format.
M	D	Position – Account Identification <AcctId>	<p>Possible market practices:</p> <ul style="list-style-type: none"> · one message per safekeeping account; · one message per client (without any mentioning of the safekeeping account details (equal to GENR in CA) without opening the Position block)

M/O	POS	Element	Clarifications, Details and Element Constraints
			· one message repeating account details in the Position block
Reason			
M	D	Cancellation Reason Code <CxIRsnCd>	WITH is to be used only in case of a cancellation/withdrawal triggered by the issuer. PROC is to be used in case of a processing error of the account servicer.
Meeting Reference			
O	D	MeetingDateAnd Time <MtgDtAndTm>	

6.2.3 [seev.008.001.07 \(MeetingResultDissemination\)](#)

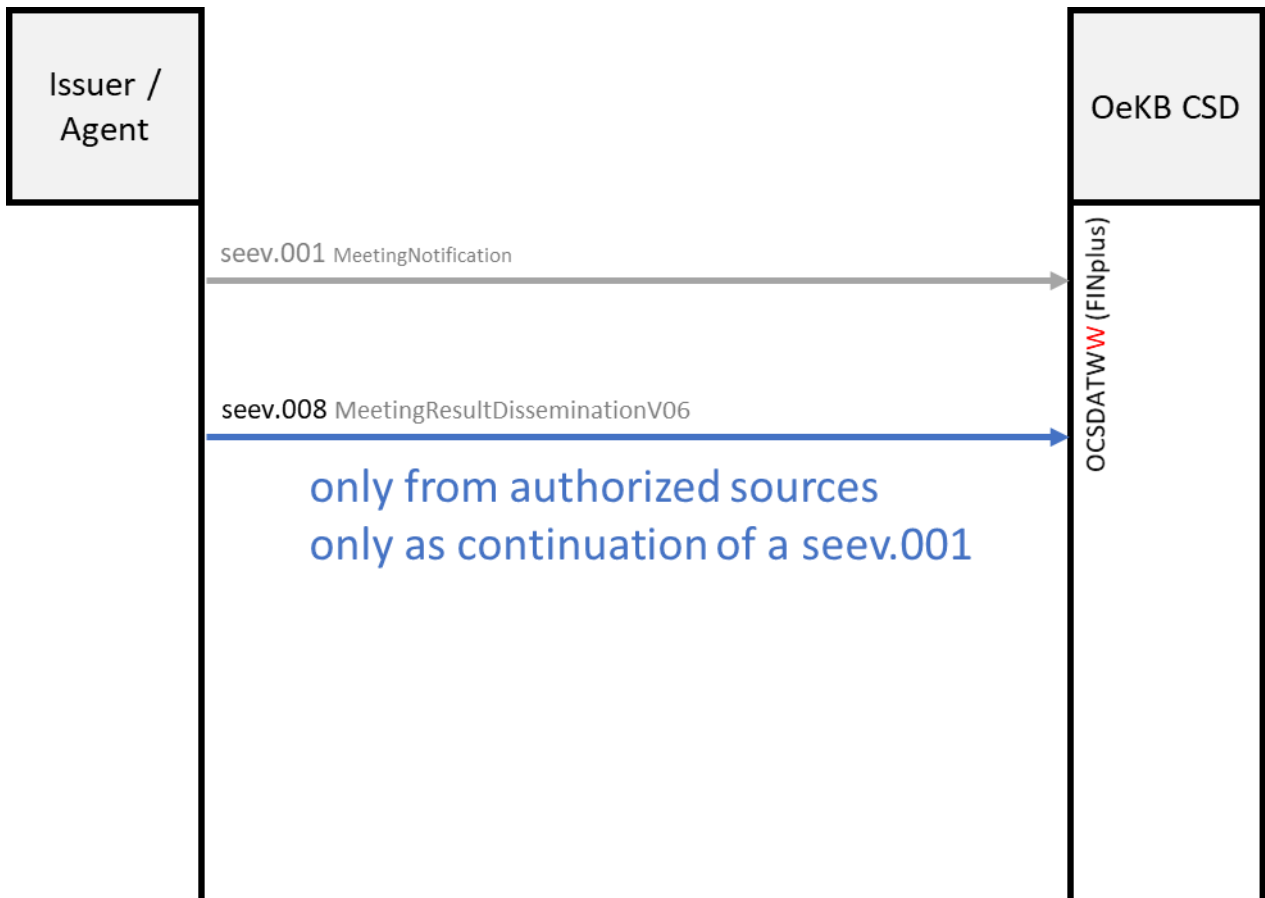

Please find below the official released descriptions by SMPG (fields not recommended by SMPG will not be considered in outgoing SWIFTS):

M/O: whether the field must be populated; **Mandatory:** must be populated for the message to be processed properly; **Optional:** processed if populated; any field **not** listed may tacitly be dropped during processing

POS: position of field in message (**B**usiness Application Header or **D**ocument Body)

Element: semantic container (ISO20022 XML Tag)

Clarifications, Details and Element Constraints: additional information on the usage of the element as well as constraints that have to be met with respect to the element

M/O	POS	Element	Clarifications, Details and Element Constraints
M	B	From, <Fr>	The sender from a business context, which can be different than the actual sender in the transport header (similar to MEOR in MT). BICFI is the only accepted format.

M/O	POS	Element	Clarifications, Details and Element Constraints
M	B	To, <To>	The receiver from a business context, which can be different than the actual receiver in the transport header (similar to MERE in MT). BICFI is the only accepted format.
M	B	Business Message Identifier, <BizMsgIdr>	The sender's unique ID/reference of the message
M	B	Message Definition Identifier, <MsgDefldr>	Contains the MessageIdentifier that defines the BusinessMessage, e.g. seev.008.001.07
M	B	CreationDate, <CreDt>	Date and time, using ISONormalisedDateTime format

Meeting Results Dissemination Type

M	D	MeetingResultsDisseminationType <MtgRsltsDssmntnTp>	A REPL message should only be sent in case of a change in the previously disseminated results.
---	---	---	--

Meeting Reference

M	D	MeetingIdentification <MtgId>	This is the account servicer identification for the general meeting. It is recommended to be used in all cases, even if the issuer has provided an identification
M	D	IssuerMeetingIdentification <IssrMtgId>	It could be used, if provided by the issuer, in addition to the MeetingIdentification, based on the SLA in place between the account servicer and account owner.
M	D	MeetingDateAndTime <MtgDtAndTm>	DateTime in UTC format is the only accepted format (YYYY-MM-DDThh:mm:ss.sssZ (Z means Zulu Time ≡ UTC time ≡ zero UTC offset))

M/O	POS	Element	Clarifications, Details and Element Constraints
M	D	Type <Tp>	

Security (the Message Building Block is repetitive, but recommended to only include one Security block per meeting event).

M	D	FinancialInstrumentIdentification <FinInstrmId>	<p>ISIN is the only accepted format.</p> <p>It is recommend to have a separate result dissemination per meeting event and ISIN</p>
M	D	Position – AccountIdentification <AcctId>	<p>Possible market practices:</p> <ul style="list-style-type: none"> · one message per safekeeping account; · one message repeating account details in the Position block

Vote Result

M	D	IssuerLabel <IssrLabl>	
M	D	ResolutionStatus <RsltnSts>	

Meeting Reference

O	D	Classification <Clsfctn>	Only Code is permitted
---	---	--------------------------	------------------------

Vote Result

O	D	For <For>	
O	D	Against <Agnst>	
O	D	Abstain <Abstn>	

M/O	POS	Element	Clarifications, Details and Element Constraints
O	D	Withhold <Wthhld>	
O	D	WithManagement <WthMgmt>	
O	D	AgainstManagement <AgnstMgmt>	
O	D	Discretionary <Dscrtnry>	
O	D	OneYear <OneYr>	
O	D	TwoYears <TwoYrs>	
O	D	ThreeYears <ThreeYrs>	
O	D	NoAction <NoActn>	
O	D	Blank <Blnk>	
Participation			
O	D	TotalNumberOfVotingRights <TtlNbOfVtngRghts>	

6.2.4 seev.045.001.03 (ShareholdersIdentificationDisclosureRequest)

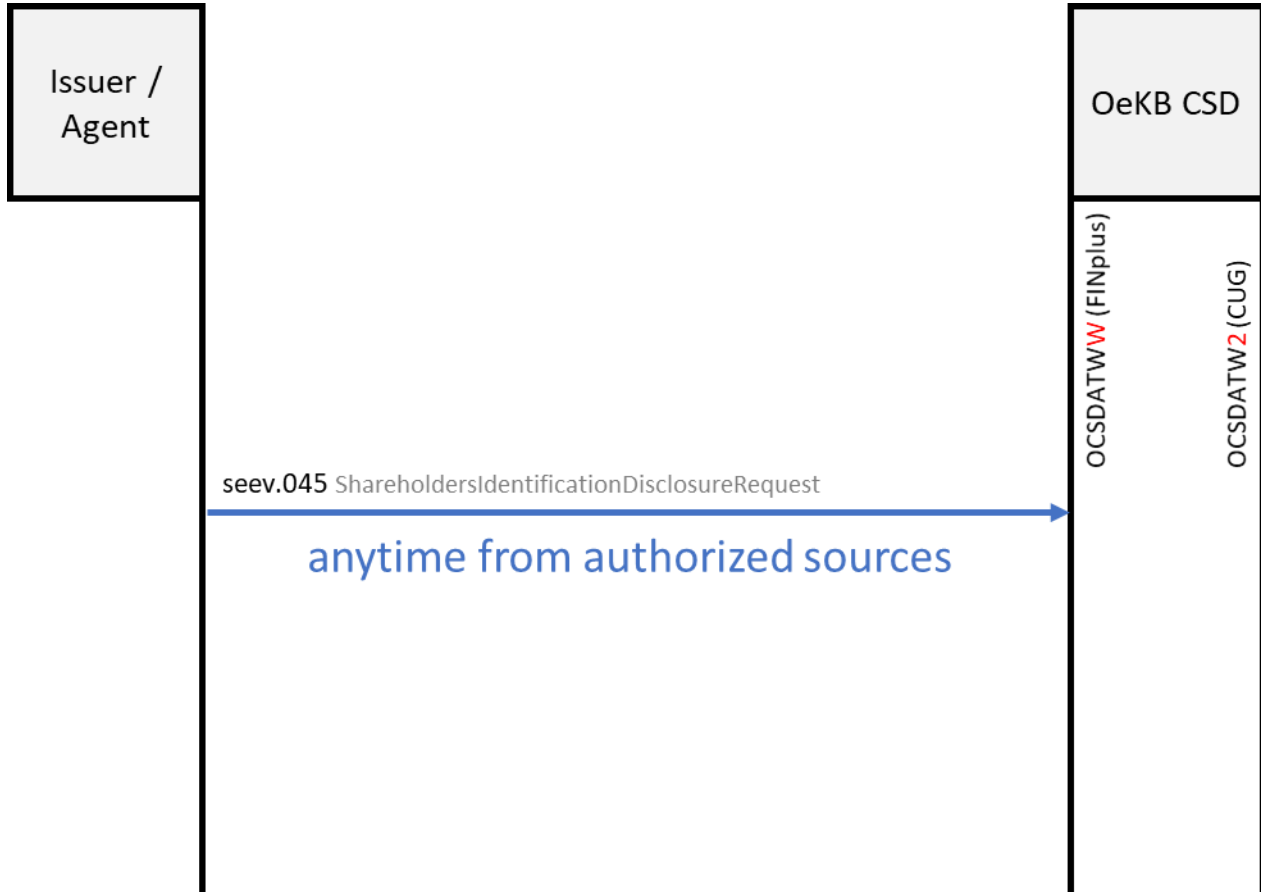

Please find below the official released descriptions by SMPG (fields not recommended by SMPG will not be considered in outgoing SWIFTS):

M/O: whether the field must be populated; **Mandatory:** must be populated for the message to be processed properly; **Optional:** processed if populated; any field **not** listed may tacitly be dropped during processing

POS: position of field in message (**B**usiness Application Header or **D**ocument Body)

Element: semantic container (ISO20022 XML Tag)

Clarifications, Details and Element Constraints: additional information on the usage of the element as well as constraints that have to be met with respect to the element

M/O	POS	Element	Clarifications, Details and Element Constraints
M	B	From, <Fr>	The sender from a business context, which can be different than the actual sender in the transport header (similar to MEOR in MT). BICFI is the only accepted format.

M/O	POS	Element	Clarifications, Details and Element Constraints
M	B	To, <To>	The receiver from a business context, which can be different than the actual receiver in the transport header (similar to MERE in MT). BICFI is the only accepted format.
M	B	BusinessMessage Identifier, <BizMsgIdr>	The sender's unique ID/reference of the message
M	B	MessageDefinitionIdentifier, <MsgDefldr>	Contains the MessageIdentifier that defines the BusinessMessage, e.g. seev.045.001.03
M	B	CreationDate, <CreDt>	Date and time, using ISONormalisedDateTime format
M	D	Issuer Disclosure Request Identification, <IssrDsclsrReqId>	
M	D	Disclosure Request Type, <DsclsrReqTp>	A REPL message should only be sent in case of a change in the issuer deadline of a previously announced request. In case any other element in the request changes, the request should be withdrawn/cancelled and a new request should be sent
M	D	Forward Request Indicator, <FwdReqInd>	Whether the request is to be forwarded in the custody chain. This indicator should always be present to avoid any misunderstanding.
M	D	ShareholderRightsDirectiveIndicator or <ShrhldrRghtsDrctvInd>	Indication whether the request is in Scope of the SRD II.
M	D	Financial Instrument	ISIN is the only accepted format.

M/O	POS	Element	Clarifications, Details and Element Constraints
		Identification, <FinInstrmId>	
M	D	Shareholders Disclosure Record Date , <ShrhldrsDscslrR crdDt >	Date (YYYY-MM-DD) is the only accepted format.
M	D	Disclosure Response Recipient - Identification, <Id>	LEI is the only accepted format.
M	D	Disclosure Response Recipient - Recipient Name, <RcptNm>	
M	D	Disclosure Response Recipient - Response Recipient Address, <RspnRcptAdr>	AnyBIC is the only accepted format.
M	D	Issuer Disclosure Deadline, <IssrDscslrDdlIn>	DateTime in UTC format is the only accepted format (YYYY-MM-DDThh:mm:ss.sssZ (Z means Zulu Time ≡ UTC time ≡ zero UTC offset))
O	D	Response Through Chain Indicator, <RspnThrhChai nInd>	If present the indicator will be ignored by OeKB CSD. Response through the chain is not supported.

M/O	POS	Element	Clarifications, Details and Element Constraints
O	D	Shares Quantity Threshold, <ShrsQtyThrshld>	If used, it has to be provided by the issuer as a quantity of shares
O	D	Request Share Held Date, <ReqShrHeldDt>	If present the indicator will be ignored by OeKB CSD.
O	D	Date Calculation Method, <DtClctnMtd>	Only to be used if the Request Share Held Date is present If present the indicator will be ignored by OeKB CSD.
O	D	Disclosure Response Deadline <DsclsrRspnDdlIn >	If present the indicator will be ignored by OeKB CSD.

6.2.5 seev.046.001.01 (ShareholdersIdentificationDisclosureRequestCancellationAdvice)

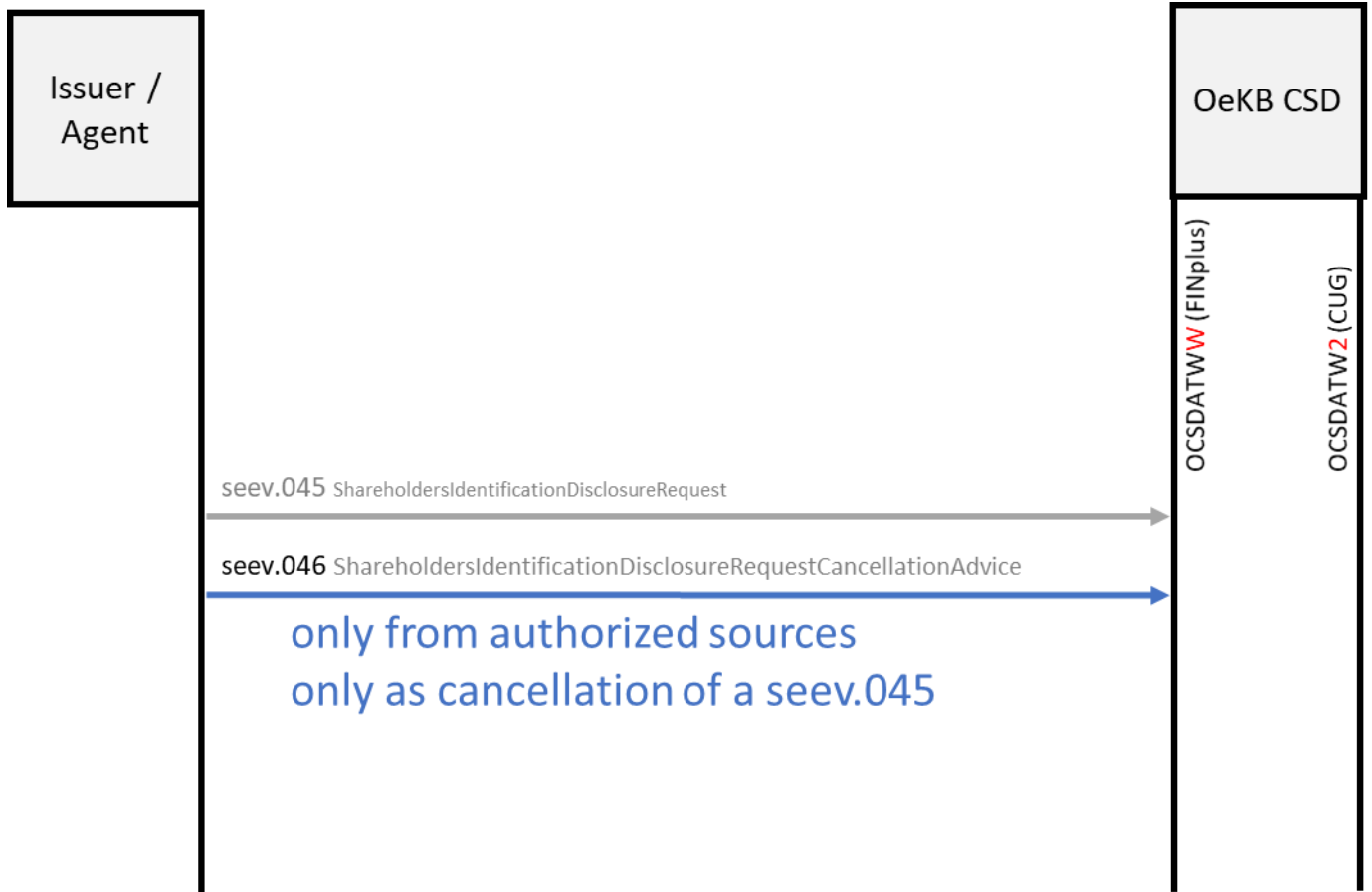

Please find below the official released descriptions by SMPG (fields not recommended by SMPG will not be considered in outgoing SWIFTS):

M/O: whether the field must be populated; **Mandatory**: must be populated for the message to be processed properly; **Optional**: processed if populated; any field **not** listed may tacitly be dropped during processing

POS: position of field in message (**B**usiness Application Header or **D**ocument Body)

Element: semantic container (ISO20022 XML Tag)

Clarifications, Details and Element Constraints: additional information on the usage of the element as well as constraints that have to be met with respect to the element

M/O	POS	Element	Clarifications, Details and Element Constraints
M	B	From, <Fr>	The sender from a business context, which can be different than the actual sender in the transport header (similar to MEOR in MT). BICFI is the only accepted format.

M/O	POS	Element	Clarifications, Details and Element Constraints
M	B	To, <To>	The receiver from a business context, which can be different than the actual receiver in the transport header (similar to MERE in MT). BICFI is the only accepted format.
M	B	BusinessMessageIdentifier, <BizMsgIdr>	The sender's unique ID/reference of the message
M	B	MessageDefinitionIdentifier, <MsgDefIdr>	Contains the MessageIdentifier that defines the BusinessMessage, e.g. seev.046.001.01
M	B	CreationDate, <CreDt>	Date and time, using ISO NormalisedDateTime format
M	D	Issuer Disclosure Request Identification, <IssrDsclsrReqId>	
M	D	Financial Instrument Identification, <FinInstrmId>	ISIN is the only accepted format.
M	D	Shareholders Disclosure Record Date, <ShrhldrsDsclsrRcrdDt >	Date (YYYY-MM-DD) is the only accepted format.
M	D	CancellationReason, <CxIRsn>	WITH is ONLY to be used in case of a cancellation triggered by the issuer or the third party appointed by the issuer.
O	B	Related – From, <Fr>	Optional block in the header, for the related message: the sender from a business context, which can be different than the actual sender in the transport header (similar to MEOR in MT). BICFI is the only supported format

M/O	POS	Element	Clarifications, Details and Element Constraints
O	B	Related – To, <To>	Optional block in the header, for the related message: the receiver from a business context, which can be different than the actual receiver in the transport header (similar to MERE in MT). BICFI is the only supported format To be used if and only if <Fr> is used.
O	B	Related – BusinessMessageIdentifier, <BizMsgIdr>	Optional block in the BAH, for the related message: the sender's unique ID/reference of the message To be used if and only if <Fr> is used.
O	B	Related – MessageDefinitionIdentifier, <MsgDefIdr>	Optional block in the header, for the related message: contains the MessageIdentifier that defines the BusinessMessage, e.g. seev.045.001.03 To be used if and only if <Fr> is used.
O	B	Related – CreationDate, <CreDt>	Optional block in the BAH, for the related message: date and time, using ISONormalisedDateTime format To be used if and only if <Fr> is used.

6.2.6 seev.049.001.01 (ShareholderIdentificationDisclosureResponseStatusAdviceV01)



Please find below the official released descriptions by SMPG (fields not recommended by SMPG will not be considered in outgoing SWIFTS):

M/O: whether the field must be populated; **Mandatory**: must be populated for the message to be processed properly; **Optional**: processed if populated; any field **not** listed may tacitly be dropped during processing

POS: position of field in message (**B**usiness Application Header or **D**ocument Body)

Element: semantic container (ISO20022 XML Tag)

Clarifications, Details and Element Constraints: additional information on the usage of the element as well as constraints that have to be met with respect to the element

M/O	POS	Element	Clarifications, Details and Element Constraints
M	B	From, <Fr>	The sender from a business context, which can be different than the actual sender in the transport header (similar to MEOR in MT). BICFI is the only accepted format.
M	B	To, <To>	The receiver from a business context, which can be different than the actual receiver in the transport header (similar to MERE in MT). BICFI is the only accepted format.
M	B	BusinessMessage Identifier, <BizMsgIdr>	The sender's unique ID/reference of the message
M	B	MessageDefinitionIdentifier, <MsgDefIdr>	Contains the MessageIdentifier that defines the BusinessMessage, e.g. seev.046.001.01
M	B	CreationDate, <CreDt>	Date and time, using ISONormalisedDateTime format
M	D	Disclosure Response Identification, <DsclsrRspnId>	
M	D	Issuer Disclosure Request Identification, <IssrDsclsrReqId>	
M	D	Financial Instrument Identification, <FinInstrmId>	ISIN is the only accepted format.
M	D	Shareholders Disclosure Record Date, <ShrhldrsDsclsrRcrdDt>	Date (YYYY-MM-DD) is the only accepted format.

M/O	POS	Element	Clarifications, Details and Element Constraints
M	D	Responding Intermediary – Name, <Nm>	
M	D	Responding Intermediary – Identification, <Id>	LEI is the only accepted format.
M	D	Response Reception Status, <RspnRcptnSts>	It can only contain the status as “accepted” or “rejected”. In case of a rejection, a rejection reason can be specified
O	B	Related – From, <Fr>	Optional block in the header, for the related message: the sender from a business context, which can be different than the actual sender in the transport header (similar to MEOR in MT). BICFI is the only supported format
O	B	Related – To, <To>	Optional block in the header, for the related message: the receiver from a business context, which can be different than the actual receiver in the transport header (similar to MERE in MT). BICFI is the only supported format To be used if and only if <Fr> is used.
O	B	Related – BusinessMessage Identifier, <BizMsgIdr>	Optional block in the BAH, for the related message: the sender’s unique ID/reference of the message To be used if and only if <Fr> is used.
O	B	Related – MessageDefinitionIdentifier, <MsgDefldr>	Optional block in the header, for the related message: contains the MessageIdentifier that defines the BusinessMessage, e.g. seev.045.001.02 To be used if and only if <Fr> is used.
O	B	Related – CreationDate, <CreDt>	Optional block in the BAH, for the related message: date and time, using ISO NormalisedDateTime format To be used if and only if <Fr> is used.

6.2.7 Not accepted Incoming Messages

OeKB CSD does **not** accept any other message type or version on any BIC/ENDPOINT, especially:

Message Type	Notification Type	Reason
seev.003.001.08	MeetingEntitlement Notification	
seev.006.001.06	MeetingInstructionStatus	instructions and voting not be communicated via the chain but directly
seev.007.001.06	MeetingVoteExecutionConfirmationV06	instructions and voting not be communicated via the chain but directly

General Meetings

General Meetings – messages not in used

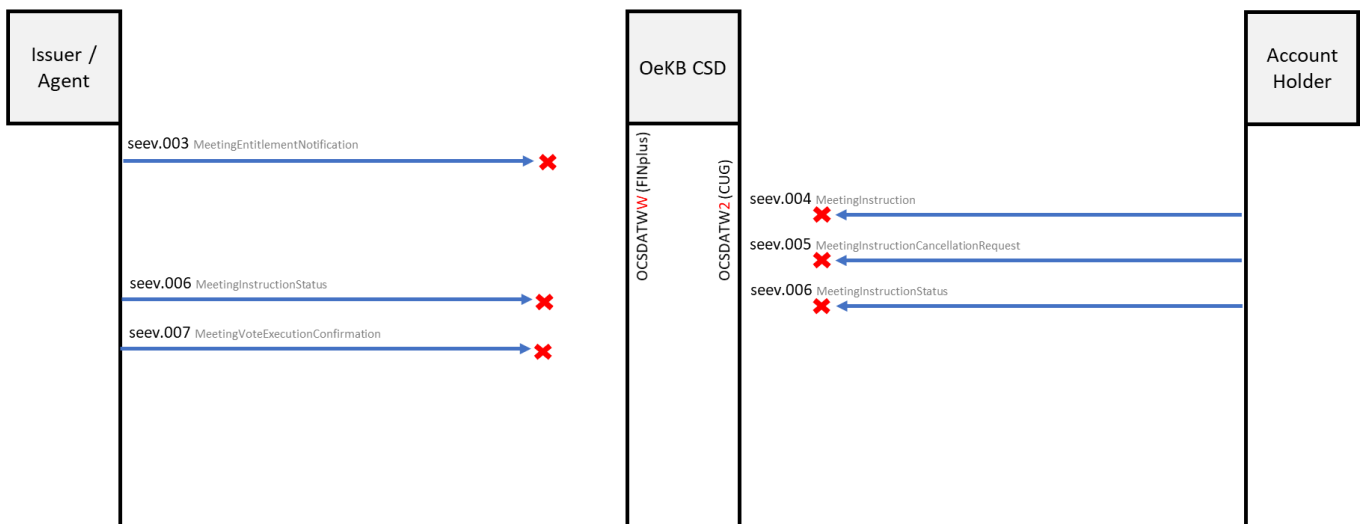

Disclosure Request

Disclosure Request– messages not in used

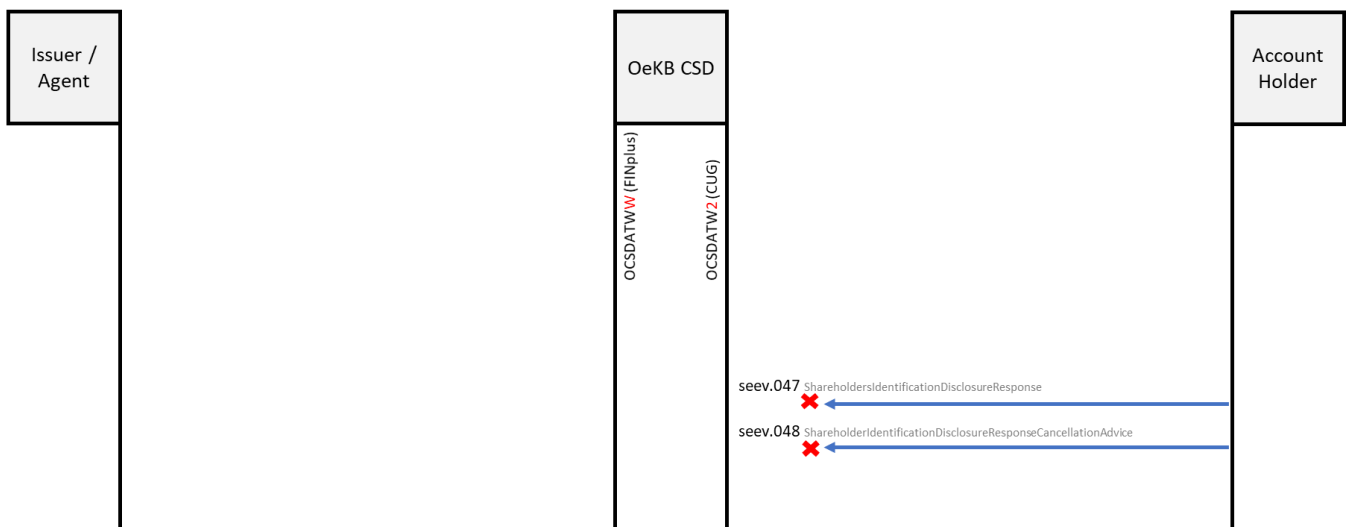

6.3 Outgoing SWIFT ISO 2022 Messages

The following message types are sent by OeKB CSD:

Message Type	Notification Type	On BIC/ENDPOINT	Technical Specification
seev.047.001.02	ShareholdersIdentificationDisclosureResponse	OCSDATWW (FINplus)	swift
seev.048.001.01	ShareholderIdentificationDisclosureResponseCancellationAdvice	OCSDATWW (FINplus)	swift

6.3.1 seev.047.001.02 (ShareholdersIdentificationDisclosureResponse)

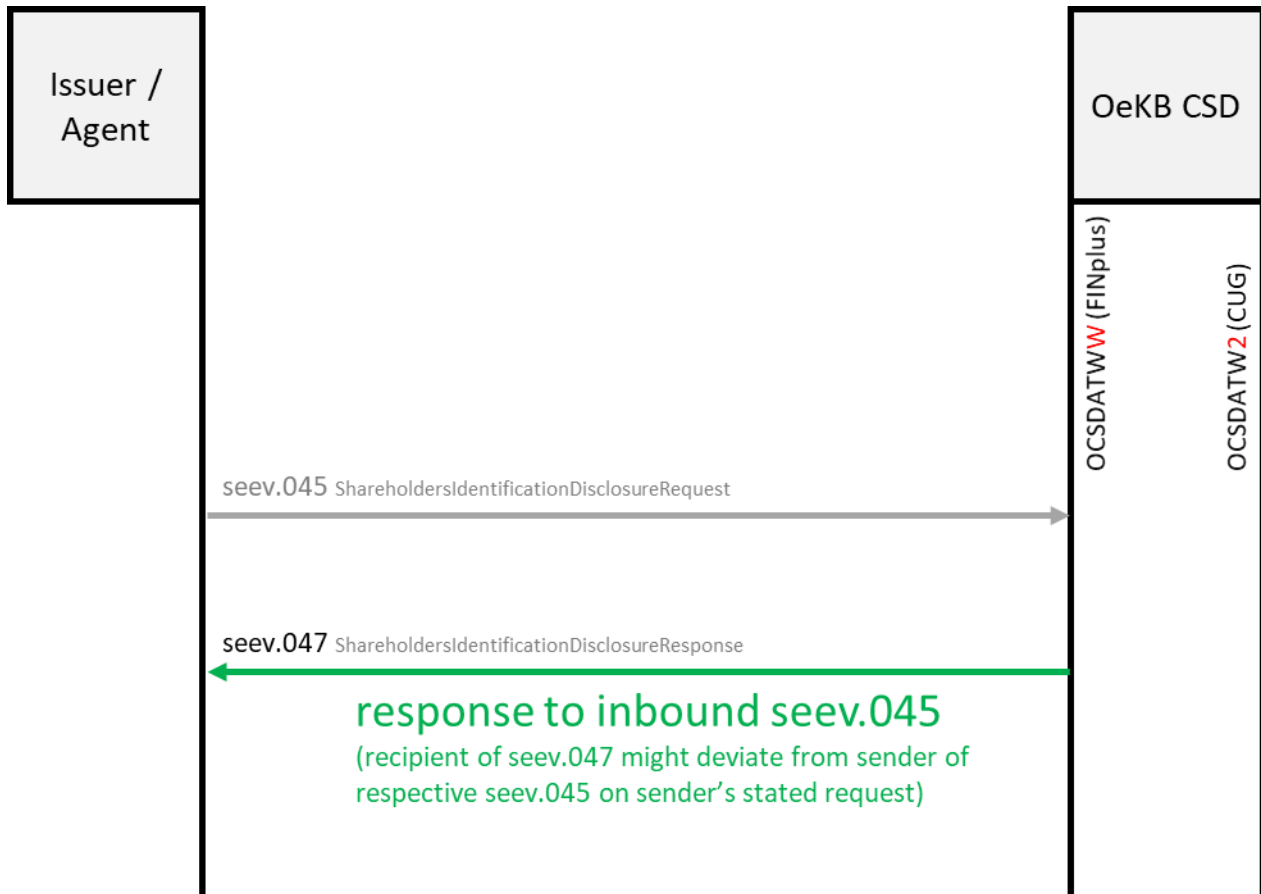

Please find below the official released descriptions by SMPG (fields not recommended by SMPG will not be considered in outgoing SWIFTS):

M/O: whether the field always is present/populated; **Mandatory:** always is populated; **Optional:** present/populated under certain conditions only

POS: position of field in message (**B**usiness Application Header or **D**ocument Body)

Element: semantic container (ISO20022 XML Tag)

Clarifications, Details and Element Constraints: additional information on the usage of the element as well as constraints that have to be met with respect to the element

M/O	POS	Element	Clarifications, Details and Element Constraints
M	B	From, <Fr>	BICFI (OCSDATWW)

M/O	POS	Element	Clarifications, Details and Element Constraints
M	B	To, <To>	BICFI (receiving party started in inbound seev.045.001.02 <RspnRcptAdr>)
M	B	BusinessMessage Identifier, <BizMsgldr>	
M	B	MessageDefinitionIdentifier, <MsgDefldr>	seev.047.001.02
M	B	CreationDate, <CreDt>	Date and time, using ISONormalisedDateTime format
M	D	Pagination	
M	D	Issuer Disclosure Request Identification, <IssrDsclsrReqId>	taken from inbound seev.045
M	D	Financial Instrument Identification, <FinInstrmId>	ISIN, taken from inbound seev.045
M	D	Shareholders Disclosure Record Date, <ShrhldrsDsclsrRcrdDt>	Date (YYYY-MM-DD), taken from inbound seev.045
M	D	Disclosure Response Identification, <DsclsrRspnId>	

M/O	POS	Element	Clarifications, Details and Element Constraints
M	D	Responding Intermediary – Name, <Nm>	OeKB CSD
M	D	Responding Intermediary – Identification, <Id>	LEI of OeKB CSD
M	D	Responding Intermediary – Contact Person, <CtctPrsn>	Name and email address
M	D	Safekeeping Account, <SfkpgAcct>	Safekeeping account that the responding intermediary has with the intermediary up the chain. ,N/A' for securities issued at OeKB CSD
M	D	Account Servicer, <AcctSvcr>	Intermediary up the chain from the responding intermediary – LEI ,N/A' for securities issued at OeKB CSD
M	D	Shareholding Balance On Own Account, <ShrhldgBalOnOwnAcct>	Zero (0)
M	D	Shareholding Balance On Client Account, <ShrhldgBalOnClientAcct>	Securities quantity held by OeKB CSD on behalf of clients
M	D	Total Shareholding Balance, <TtlShrhldgBal>	Securities quantity held by OeKB CSD on behalf of clients

M/O	POS	Element	Clarifications, Details and Element Constraints
M	D	Safekeeping Account, <SfkpgAcct>	Account number at the Account Servicer (if populated)
M	D	Securities Account Holder – Legal Person – Name And Address, <NmAndAdr>	Disclosed Securities Account Holder name and address
M	D	Securities Account Holder – Legal Person – Identification, <Id>	Disclosed Securities Account Holder LEI
M	D	Shareholding Type, <ShrhldgTp>	,U'
M	D	Quantity, <Qty>	Securities quantity held by OeKB CSD on behalf of Securities Account Holder
O	D	Non Disclosed Shareholding Quantity, <NonDscldShrhldgQty>	This element used to indicate any securities quantity held by customers of OeKB CSD who have prohibited disclosure (if populated)
O	D	Below Threshold Shareholding Quantity, <BlwThrshldShrhldgQty>	This element used to indicate any securities quantity held by customers of OeKB CSD having a balance below threshold (if populated)
O	D	Initial Date Of Shareholding, <InitlDtOfShrhldg>	Date (YYYY-MM-DD) if populated

M/O	POS	Element	Clarifications, Details and Element Constraints
O	D	Third Party – Role, <Role>	To be used with code DECM, to report the details of the third party who is authorised to take investment decisions on behalf of the shareholder
O	D	Third Party – Name, <Nm>	To be used to report the name of the third party
O	D	Third Party – Identification, <Id>	LEI if populated

6.3.2 seev.048.001.01 (ShareholderIdentificationDisclosureResponseCancellationAdvice)

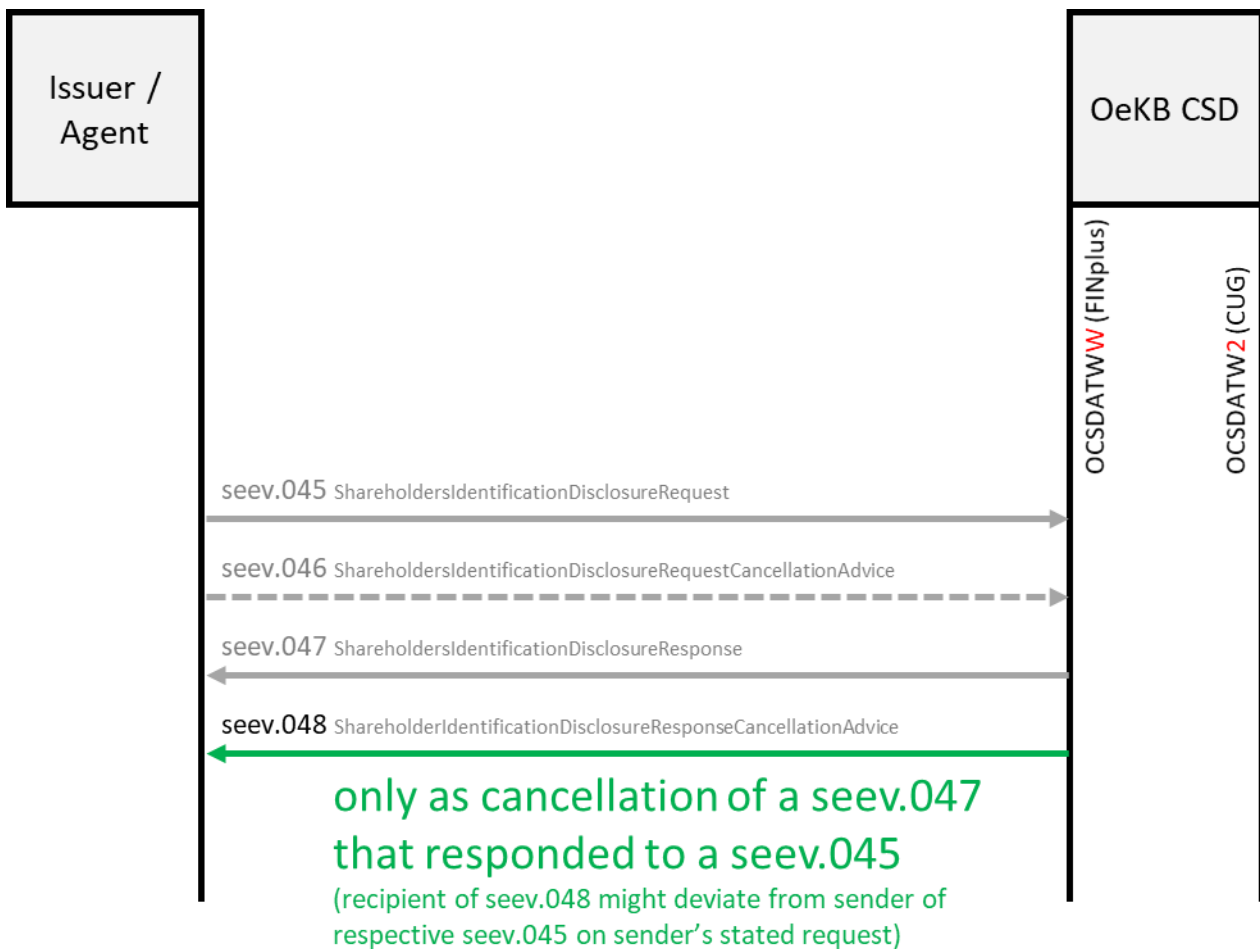

Please find below the official released descriptions by SMPG (fields not recommended by SMPG will not be considered in outgoing SWIFTS):

M/O: whether the field always is present/populated; **Mandatory:** always is populated; **Optional:** present/populated under certain conditions only

POS: position of field in message (Business Application Header or Document Body)

Element: semantic container (ISO20022 XML Tag)

Clarifications, Details and Element Constraints: additional information on the usage of the element as well as constraints that have to be met with respect to the element

M/O	POS	Element	Clarifications, Details and Element Constraints
M	B	From, <Fr>	BICFI (OCSDATWW)
M	B	To, <To>	BICFI (receiving party started in inbound seev.045.001.02 <RspnRcptAdr>)
M	B	BusinessMessage Identifier, <BizMsgIdr>	
M	B	MessageDefinitionIdentifier, <MsgDefIdr>	seev.048.001.01
M	B	CreationDate, <CreDt>	Date and time, using ISONormalisedDateTime format
M	D	Issuer Disclosure Request Identification, <IssrDsclsrReqId>	taken from inbound seev.045
M	D	Financial Instrument Identification, <FinInstrmId>	ISIN, taken from inbound seev.045
M	D	Shareholders Disclosure Record Date,	Date (YYYY-MM-DD), taken from inbound seev.045

M/O	POS	Element	Clarifications, Details and Element Constraints
		<ShrhldrsDsclsrR crdDt>	
M	D	Disclosure Response Identification, <DsclsrRspnId>	
M	D	Responding Intermediary – Name, <Nm>	OeKB CSD
M	D	Responding Intermediary – Identification, <Id>	LEI of OeKB CSD
O	B	Related – From, <Fr>	not used, reserved for future use
O	B	Related – To, <To>	not used, reserved for future use
O	B	Related – BusinessMessage Identifier, <BizMsgIdr>	not used, reserved for future use
O	B	Related – MessageDefinitio nIdentifier, <MsgDefldr>	not used, reserved for future use
O	B	Related – CreationDate, <CreDt>	not used, reserved for future use

